

SECTION X-X

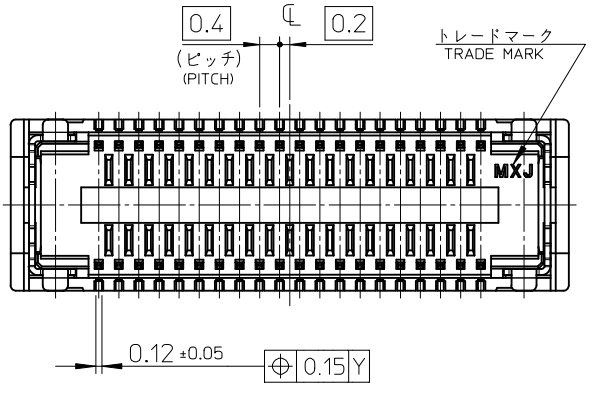

9.32	7.6	11.1	501527-0410	501527-0419	40
8.12	6.4	9.9	501527-3410	501527-3419	34
D	B	A	EMBOSSSED TAPE PKG.	MATERIAL No.	CKT.
			ORDER No. オーダー番号	MODEL No. : 501527-**19	

REVISED EC NO: J2015-1111 DRW: TARA 01 2015/02/26 CHK: K.TANAKA 03 2015/02/26 APPR: KMORI KAWA 2015/02/26	GENERAL TOLERANCES (UNLESS SPECIFIED)		DIMENSION STYLE		SCALE	DESIGN UNITS	THIRD ANGLE PROJECTION
	0.25 UNDER ±0.03		MM ONLY		10:1	METRIC	☉
	0.25 OVER	0.5 UNDER ±0.05	DRAWN BY RTAKEUCH		DATE 2006/01/20		TITLE
	0.5 OVER	1.0 UNDER ±0.1	CHECKED BY THIRATA		DATE 2006/01/20		0.4 B-TO-B CONN. HGT=1.3 REC ASSY -LEAD FREE- molex
	1.0 OVER	10 UNDER ±0.2	APPROVED BY MSASAO		DATE 2006/01/20		
30 OVER	±0.25	MATERIAL NO.		DOCUMENT NO.		SHEET NO.	
ANGULAR	±3 °	SEE CHART		SD-501527-003		1 OF 2	
DRAFT WHERE APPLICABLE MUST REMAIN WITHIN DIMENSIONS			SIZE	THIS DRAWING CONTAINS INFORMATION THAT IS PROPRIETARY TO MOLEX INCORPORATED AND SHOULD NOT BE USED WITHOUT WRITTEN PERMISSION			
			A3				

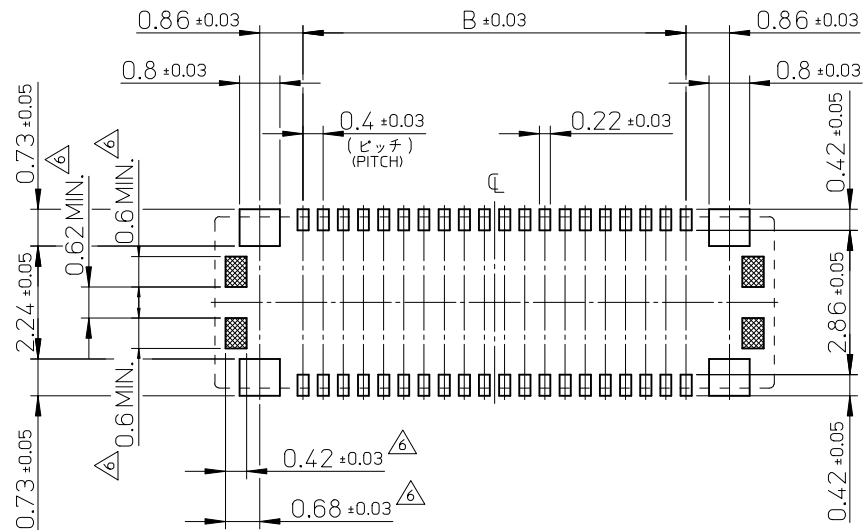

参考基板レイアウト (マウント面)
P.C. BOARD PATTERN DIMENSION (REFERENCE)
(MOUNTING AREA)

注記 NOTES

1. 使用材料 MATERIAL

ハウジング: 液晶ポリマー (LCP) ガラス充填 UL94V-0 (黒)
HOUSING: LIQUID CRYSTAL POLYMER (GLASS FILLED) UL94V-0 (COLOR: BLACK)

ターミナル: りん青銅 (t=0.12)
TERMINAL: PHOSPHOR BRONZE (t=0.12)

金具: コルソン銅 (t=0.12)
FITTING NAIL: CORSON TYPE COPPER ALLOY (t=0.12)

2. メッキ仕様 PLATING

ターミナル TERMINAL

金メッキ 0.2 マイクロメートル以上 (コンタクト部)
GOLD 0.2 MICROMETER MINIMUM (CONTACT AREA)

金メッキ 0.4 マイクロメートル以下 (テール部)
GOLD 0.4 MICROMETER MAXIMUM (TAIL AREA)

下地メッキ: ニッケルメッキ 1.5 マイクロメートル以上
UNDER PLATING: NICKEL 1.5 MICROMETER MINIMUM

※コンタクト部とテール部はニッケルメッキによって分断されている金メッキです。
DIVIDE INTO PARTS THE GOLD PLATING OF THE CONTACT AND THE TAIL PART BY THE NICKEL PLATING.

金具 FITTING NAIL

半田付け処理 (金・パラジウムコート)
SOLDERABILITY IMPROVEMENT COAT (Au & Pd COAT)

下地メッキ: ニッケルメッキ 1.0 マイクロメートル以上
UNDER PLATING: NICKEL 1.0 MICROMETER MINIMUM

△3 (全極数 / 2) = 偶数の場合に適用。
APPLY FOR (CIRCUIT/2)=EVEN.

4. 嵌合相手: 501531 シリーズ
MATE WITH: 501531 SERIES.

5. テール平坦度は、0.08 以下

テール及び金具の平坦度は、0.1 以下
TAIL COPLANARITY TO BE 0.08 MAXIMUM.
TAIL AND FITTING NAIL COPLANARITY TO BE 0.1 MAXIMUM.

△6 斜線部はパターン書き込み禁止範囲と半田禁止範囲を示す。
ただし、斜線部に補強金具と同一配線を配置する場合はレジストを施し、この部分に半田は無きこと。
NO PATTERN CIRCUIT AND NO SOLDER ALLOWED IN THE SHADED AREA.
HOWEVER, IF NEEDED TO ADD A TRACE OF THE SAME CIRCUIT, PUT THE SOLDER-RESIST.
YET NO SOLDER ALLOWED IN THE AREA.

7. ELV and RoHS COMPLIANT.

REVISED EC NO: J2015-1111 DRWN: TARA 01 2015/02/26 CHKD: TANAKA 03 2015/02/26 APP: KMORI KAWA 2015/02/26	GENERAL TOLERANCES (UNLESS SPECIFIED)		DIMENSION STYLE MM ONLY		SCALE 10:1	DESIGN UNITS METRIC	THIRD ANGLE PROJECTION	
	0.25 UNDER	± 0.03	DRAWN BY	DATE	TITLE			
	0.25 OVER 0.5 UNDER	± 0.05	RTAKEUCH	2006/01/20	0.4 B-TO-B CONN. HGT=1.3 REC ASSY -LEAD FREE-			
	0.5 OVER 1.0 UNDER	± 0.1	CHECKED BY	DATE				
1.0 OVER 10 UNDER	± 0.2	THIRATA	2006/01/20					
10 OVER 30 UNDER	± 0.25	APPROVED BY	DATE	MATERIAL NO.		DOCUMENT NO.		SHEET NO.
30 OVER	± 0.3	MSASAO	2006/01/20	SEE SHEET 1		SD-501527-003		2 OF 2
ANGULAR ±3 °		DRAFT WHERE APPLICABLE MUST REMAIN WITHIN DIMENSIONS		SIZE A3	THIS DRAWING CONTAINS INFORMATION THAT IS PROPRIETARY TO MOLEX INCORPORATED AND SHOULD NOT BE USED WITHOUT WRITTEN PERMISSION			

10 9 8 7 6 5 4 3 2 1

F

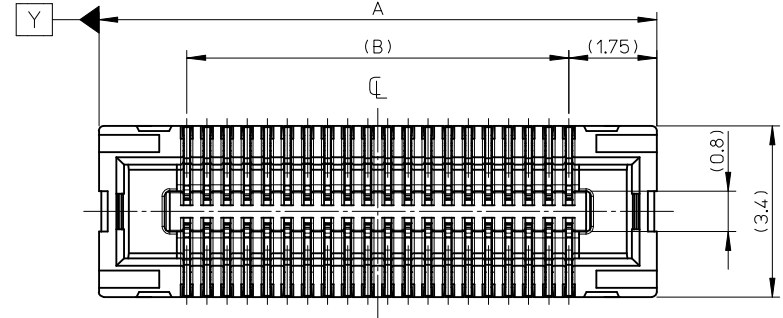

E

D

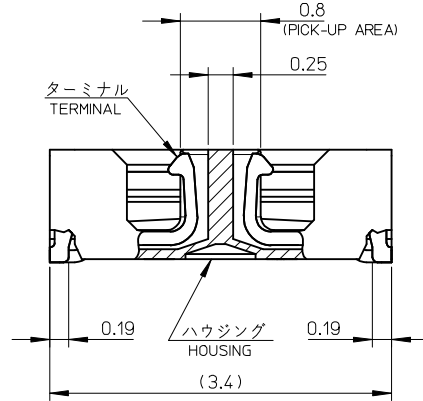
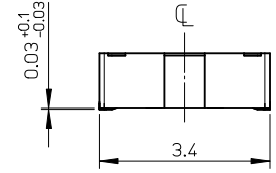
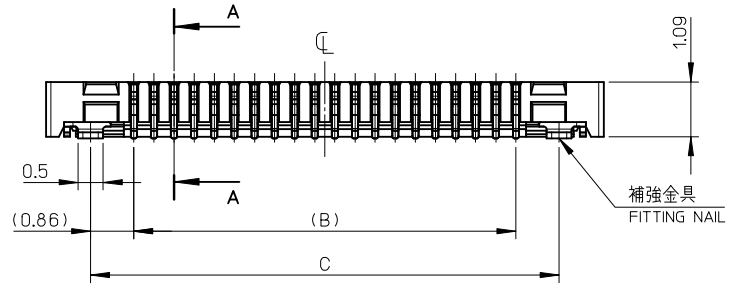

SECTION A-A
SCALE 20:1

C

B

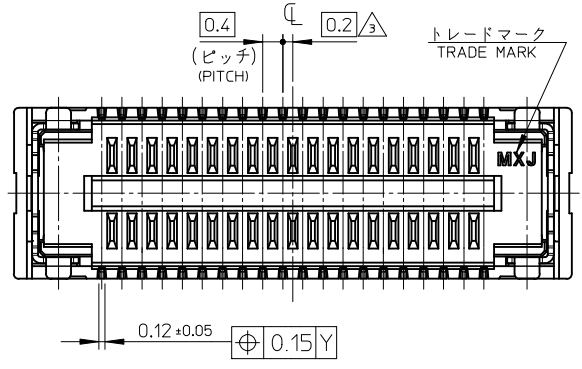

A

19.32	17.6	21.1	505225-0900	90
C	B	A	EMBOSSED PACKAGE	極数
			オーダー番号 ORDER NO.	CIRCUITS
			CONNECTOR SERIES No. 505225-**09	

RELEASED EC NO: J2015-0069 DRWN: JFURUKAWA 2014/07/14 CHKD: TASAKAWA 2014/07/14 APPR: KMORIKAWA 2014/12/08	DESCRIPTION GENERAL TOLERANCES (UNLESS SPECIFIED) 10 UNDER ±0.2 10 OVER 30 UNDER ±0.25 30 OVER ±0.3 ANGULAR ±3 ° DRAFT WHERE APPLICABLE MUST REMAIN WITHIN DIMENSIONS	DIMENSION STYLE MM ONLY	SCALE 10:1	DESIGN UNITS METRIC	THIRD ANGLE PROJECTION		
		DRAWN BY JFURUKAWA	DATE 2014/07/14	TITLE 0.4 B-TO-B CONN. HGT=1.3 REC ASSY -LEAD FREE-			
		CHECKED BY TASAKAWA	DATE 2014/07/14	MATERIAL NO. SEE CHART			
		APPROVED BY KMORIKAWA	DATE 2014/12/08	DOCUMENT NO. SD-505225-001	SHEET NO. 1 OF 2		
		SIZE A3	THIS DRAWING CONTAINS INFORMATION THAT IS PROPRIETARY TO MOLEX INCORPORATED AND SHOULD NOT BE USED WITHOUT WRITTEN PERMISSION				

9 8 7 6 5 4 3 2

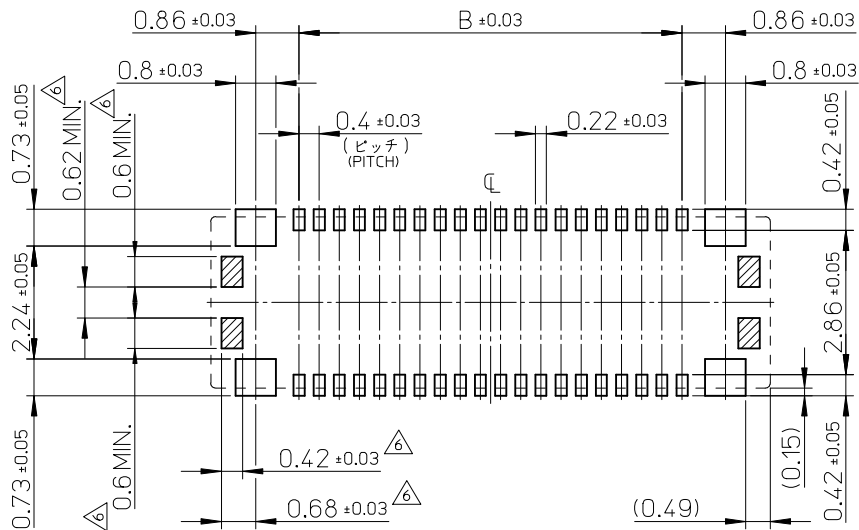

参考基板レイアウト (マウント面)
P.C. BOARD PATTERN DIMENSION (REFERENCE)
(MOUNTING AREA)

メタルマスク厚: 0.1
METAL MASK THICKNESS: 0.1

開口率: 100%
APERTURE RATIO: 100%

注記 NOTES

1. 使用材料 MATERIAL

ハウジング: 液晶ポリマー (LCP) ガラス充填 UL94V-0 (黒)
HOUSING: LIQUID CRYSTAL POLYMER (GLASS FILLED) UL94V-0 (COLOR: BLACK)

ターミナル: りん青銅 (t=0.12)
TERMINAL: PHOSPHOR BRONZE (t=0.12)

金具: 銅合金 (t=0.12)
FITTING NAIL: COPPER ALLOY (t=0.12)

2. メッキ仕様 PLATING

ターミナル TERMINAL

コンタクト部: 金メッキ 0.1 マイクロメートル以上
CONTACT AREA: GOLD 0.1 MICROMETER MINIMUM

テール部: 金メッキ
TAIL AREA: GOLD

下地メッキ: ニッケルメッキ 1.5 マイクロメートル以上
UNDER PLATING: NICKEL 1.5 MICROMETER MINIMUM

※コンタクト部とテール部はニッケルメッキによって分断されている金メッキです。
DIVIDE INTO PARTS THE GOLD PLATING OF THE CONTACT AND THE TAIL PART BY THE NICKEL PLATING.

金具 FITTING NAIL

半田付け処理 (金・パラジウムコート)
SOLDERABILITY IMPROVEMENT COAT (Au & Pd COAT)

下地メッキ: ニッケルメッキ 1.0 マイクロメートル以上
UNDER PLATING: NICKEL 1.0 MICROMETER MINIMUM

③ (全極数 / 2) = 偶数の場合に適用。
APPLY FOR (CIRCUIT/2)=EVEN.

4. 嵌合相手: 505226 シリーズ
MATE WITH: 505226 SERIES.

5. テール平坦度は、0.08 以下

テール及び金具の平坦度は、0.1 以下
TAIL COPLANARITY TO BE 0.08 MAXIMUM.
TAIL AND FITTING NAIL COPLANARITY TO BE 0.1 MAXIMUM.

⑥ 斜線部はパターン書き込み禁止範囲と半田禁止範囲を示す。
ただし、斜線部に補強金具と同一配線を配置する場合はレジストを施し、この部分に半田は無きこと。
NO PATTERN CIRCUIT AND NO SOLDER ALLOWED IN THE SHADED AREA.
HOWEVER, IF NEEDED TO ADD A TRACE OF THE SAME CIRCUIT, PUT THE SOLDER-RESIST.
YET NO SOLDER ALLOWED IN THE AREA.

7. ELV & RoHS 適合品。
ELV and RoHS COMPLIANT.

RELEASED EC NO: J2015-0069 DRWN: JFURUKAWA 2014/07/14 CHKD: TASAKAWA 2014/07/14 APPR: KMORIKAWA 2014/12/08 REV: 0	GENERAL TOLERANCES (UNLESS SPECIFIED)		DIMENSION STYLE MM ONLY	SCALE 10:1	DESIGN UNITS METRIC	THIRD ANGLE PROJECTION
	10 UNDER	± 0.2	DRAWN BY JFURUKAWA	DATE 2014/07/14	TITLE 0.4 B-TO-B CONN. HGT=1.3 REC ASSY -LEAD FREE-	
	10 OVER 30 UNDER	± 0.25	CHECKED BY TASAKAWA	DATE 2014/07/14		
	30 OVER	± 0.3	APPROVED BY KMORIKAWA	DATE 2014/12/08		
ANGULAR ± 3 °		MATERIAL NO. SEE SHEET 1		DOCUMENT NO. SD-505225-001		SHEET NO. 2 OF 2
DRAFT WHERE APPLICABLE MUST REMAIN WITHIN DIMENSIONS		THIS DRAWING CONTAINS INFORMATION THAT IS PROPRIETARY TO MOLEX INCORPORATED AND SHOULD NOT BE USED WITHOUT WRITTEN PERMISSION				