

ADMIRAL CLASS - INTERNATIONAL LEAD WIRES, POWER TRANSFORMER

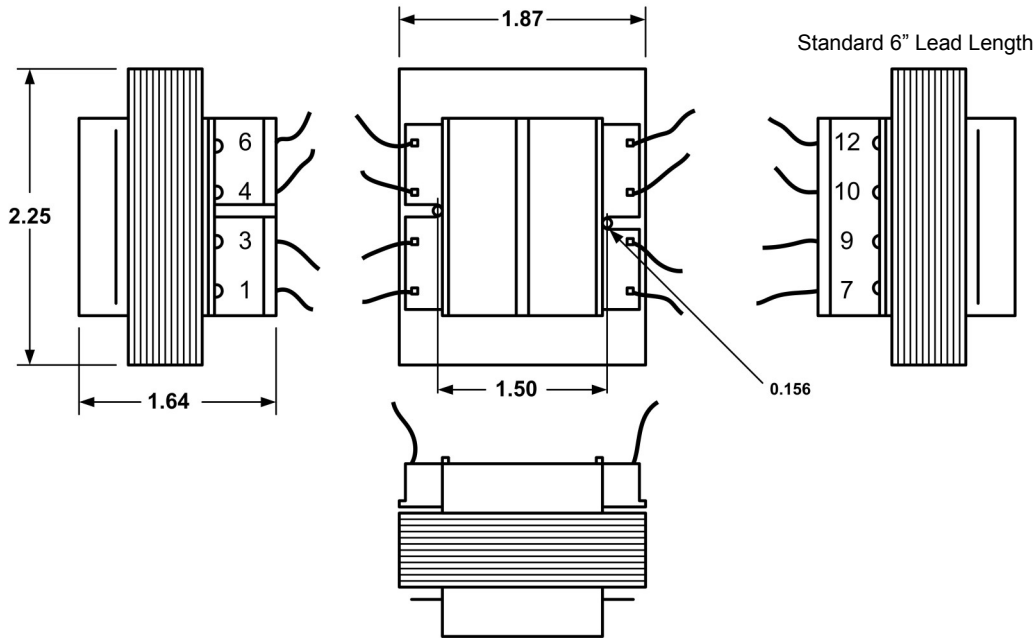

1. Electrical Specifications

- A. Maximum Power: 20VA
- B. Input Voltage and Frequency: 115V, 115/230V, 230V 50/60Hz
- C. Voltage Regulation: ___% TYP @ full load to no load
- D. Temperature Rise: ___°C TYP
- E. Insulation Resistance: _____
- F. Hi-Pot: 4000Vrms 1 minute @ Pri to Sec
 _____Vrms 1 minute @ Pri to Core
 _____Vrms 1 minute @ Sec to Core

- 2. Marking: Ensign Corp, part number (see table), date code
- 3. Safety:

UL/cUL 5085-2 Recognized (File 47299)
 UL 60950 Recognized (File E144070)
 VDE 0805 Licensed (File 19019-3336-9002/A1C)
 UL 1446 Recognized Insulation System (File 95662)

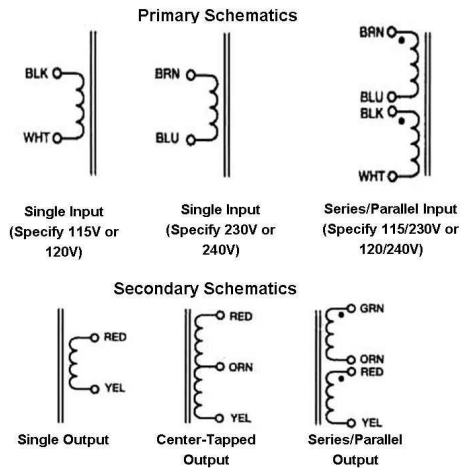

Part Number			Series Connection	Parallel Connection
115V	115/230V	230V		
IL020-1-010X	IL020-2-010X	IL020-3-010X	10VCT @ 2.0A	5V @ 4.0A
IL020-1-012X	IL020-2-012X	IL020-3-012X	12.6VCT @ 1.6A	6.3V @ 3.2A
IL020-1-016X	IL020-2-016X	IL020-3-016X	16VCT @ 1.25A	8V @ 2.5A
IL020-1-020X	IL020-2-020X	IL020-3-020X	20VCT @ 1.0A	10V @ 2.0A
IL020-1-024X	IL020-2-024X	IL020-3-024X	24VCT @ 0.83A	12V @ 1.66A
IL020-1-028X	IL020-2-028X	IL020-3-028X	28VCT @ 0.72A	14V @ 1.44A
IL020-1-036X	IL020-2-036X	IL020-3-036X	36VCT @ 0.56A	18V @ 1.12A

<p>ENSIGN THE FLAGSHIP OF CUSTOM MAGNETICS SINCE 1939</p>	<p>POWER TRANSFORMER ADMIRAL CLASS</p>		<p>IL020-1-XXXX IL020-2-XXXX IL020-3-XXXX</p>	
	<p>CONTENTS OF THIS DRAWING ARE SUBJECT TO CHANGE WITHOUT PRIOR NOTICE</p>		<p>Ensign Corporation 201 ENSIGN RD., BELLEVUE, IA 52031</p>	<p>Dim: Inches</p>
<p>PROPRIETARY NOTICE: THIS DRAWING PRINT OR DOCUMENT AND SUBJECT MATTER DISCLOSED HEREIN ARE PROPRIETARY ITEMS TO WHICH ENSIGN RETAINS THE EXCLUSIVE RIGHT OF DISSEMINATION, MANUFACTURE AND SALE. THIS DRAWING, PRINT OR DOCUMENT IS SUBMITTED IN CONFIDENCE FOR CONSIDERATION BY THE RECIPIENT ALONE UNLESS PERMISSION FOR FURTHER DISCLOSURE IS EXPRESSLY GRANTED IN WRITING</p>				