

CAPTAIN CLASS - PRINTED CIRCUIT MOUNT, STANDARD PROFILE POWER TRANSFORMER

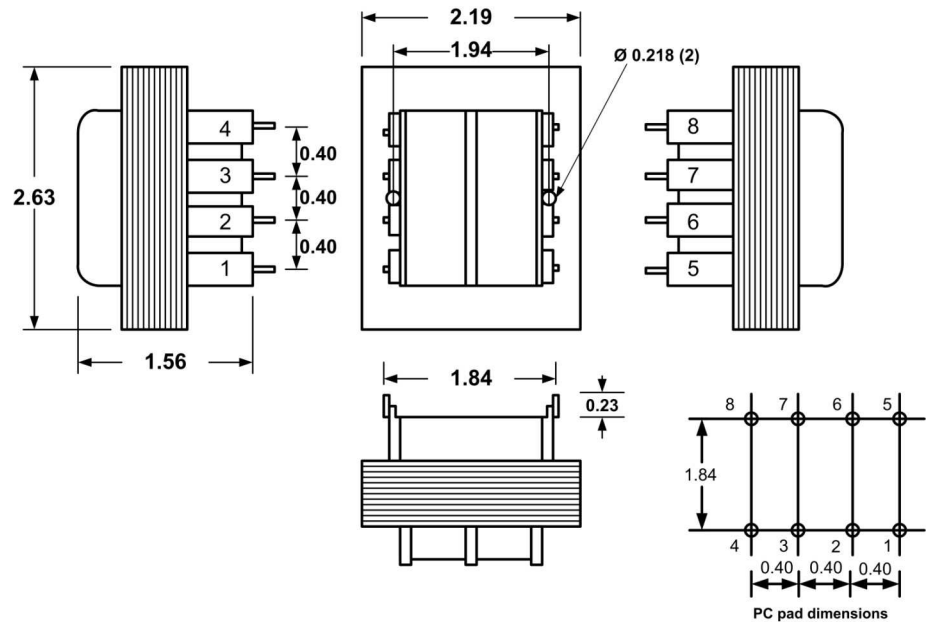

1. Electrical Specifications

- A. Maximum Power: 36VA
- B. Input Voltage and Frequency: 115V, 115/230V, 230V @ 50/60Hz
- C. Voltage Regulation: 13% TYP @ Full Load to No Load
- D. Temperature Rise: 40°C TYP
- E. Insulation Resistance: > 1 MEG ohm
- F. Hi-Pot: 2500 Vrms 1 minute @ Pri to Sec
2500 Vrms 1 minute @ Pri to Core
1500 Vrms 1 minute @ Sec to Core

2. Marking: Ensign Corp, part number (see table), date code, terminal numbers

3. Safety:

UL/cUL 5085-2 Recognized (File 47299)

UL 1446 Recognized Insulation System (File 95662)



Primary Schematics

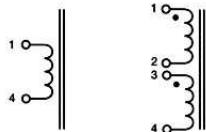

Single Input
(Specify 115V,
120V, 230V or
240V)

Dual Input
(Specify
115/230V or
120/240V)

Secondary Schematics

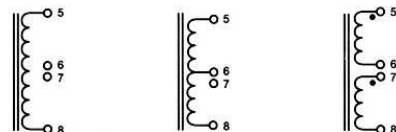

Single Output

Center-Tapped Output

Dual Output

Part No.			Series Connection	Parallel Connection
115V	115/230V	230V		
P036-1-010X	P036-2-010X	P036-3-010X	10VCT @ 3.6A	5V @ 7.2A
P036-1-012X	P036-2-012X	P036-3-012X	12.6VCT @ 2.85A	6.3V @ 5.7A
P036-1-016X	P036-2-016X	P036-3-016X	16VCT @ 2.25A	8V @ 4.5A
P036-1-020X	P036-2-020X	P036-3-020X	20VCT @ 1.8A	10V @ 3.6A
P036-1-024X	P036-2-024X	P036-3-024X	24VCT @ 1.5A	12V @ 3.0A
P036-1-028X	P036-2-028X	P036-3-028X	28VCT @ 1.3A	14V @ 2.6A
P036-1-036X	P036-2-036X	P036-3-036X	36VCT @ 1.0A	18V @ 2.0A
P036-1-048X	P036-2-048X	P036-3-048X	48VCT @ 0.75A	24V @ 1.5A
P036-1-056X	P036-2-056X	P036-3-056X	56VCT @ 0.65A	28V @ 1.3A
P036-1-120X	P036-2-120X	P036-3-120X	120VCT @ 0.3A	60V @ 0.6A



**POWER TRANSFORMER
CAPTAIN CLASS**

**P036-1-XXXX
P036-2-XXXX
P036-3-XXXX**

CONTENTS OF THIS DRAWING ARE SUBJECT TO CHANGE WITHOUT PRIOR NOTICE

Ensign Corporation
201 ENSIGN RD., BELLEVUE, IA 52031

Dim: Inches

Sheet 1 of 1

PROPRIETARY NOTICE: THIS DRAWING PRINT OR DOCUMENT AND SUBJECT MATTER DISCLOSED HEREIN ARE PROPRIETARY ITEMS TO WHICH ENSIGN RETAINS THE EXCLUSIVE RIGHT OF DISSEMINATION, MANUFACTURE AND SALE. THIS DRAWING, PRINT OR DOCUMENT IS SUBMITTED IN CONFIDENCE FOR CONSIDERATION BY THE RECIPIENT ALONE UNLESS PERMISSION FOR FURTHER DISCLOSURE IS EXPRESSLY GRANTED IN WRITING