

## Li-ion Battery Charger

The ISL9205 is an integrated single-cell Li-ion or Li-polymer charger capable of operating at an input voltage as low as 2.5V. The low operating voltage allows the charger to work with a variety of AC adapters.

The ISL9205 operates as a linear charger when the AC adapter is a voltage source. The battery is charged in a standard Li-ion charge profile, i.e. a constant current phase followed by a constant voltage phase (CC/CV). The charge current during the constant current phase is determined by the external resistor connected to the  $I_{REF}$  pin. When the adapter output is a current-limited voltage source and the current limit is smaller than the programmed constant current of the IC, the ISL9205 operates as a pulse charger where the charge current is determined by the current limit of the AC adapter during the constant current phase. The ISL9205 operates in a linear mode during the constant voltage phase in both adapter cases.

The ISL9205 incorporates Thermaguard™ which protects the IC against over temperature. If the die temperature rises above a typical value of +100°C, the thermal foldback function reduces the charge current to prevent further temperature rise. The ISL9205 includes an external temperature monitoring function (not available in some package options). A negative temperature coefficient (NTC) thermistor is connected between the TEMP pin and GND to monitor the battery or ambient temperature. The ISL9205 also includes a timer to set the time reference for various charge time limits. The timer is programmable with an external capacitor. Two logic inputs and two open-drain logic outputs are available for controlling the charger and indicating the charger status. The EN pin enables the charger, TOEN pin (available in ISL9205) enables the timeout function so that the charge is terminated when the preset time limits have been reached. The FAULT pin is an open-drain output which turns on when a fault condition is encountered. The STATUS pin is also an open-drain output which turns on when the charger is delivering current.

## Features

- Complete Charger for Single-Cell Li-ion/Polymer Batteries
- Integrated Pass Element and Current Sensor
- No External Blocking Diode Required
- Low Component Count and Cost
- 25mV Voltage Accuracy Over-Temperature and Input Voltage Range
- 15mV Voltage Accuracy at Room Temperature
- Programmable Charge Current
- **Programmable End-of-Charge Current (ISL9205)**
- **Charge Current Thermal Foldback for Thermal Protection (Thermaguard™)**
- Trickle Charge for Fully Discharged Batteries
- Power Presence and Charge Indications
- NTC Interface (not available in some package options)
- Less than 3μA Leakage Current off the Battery when No Input Power Attached or Charger Disabled
- Ambient Temperature Range: -40°C to +85°C
- DFN, QFN Packages
- Pb-Free (RoHS Compliant)

## Applications

- Mobile Phones
- Blue-Tooth Devices
- PDAs
- MP3 Players
- Stand-Alone Cradle or Travel Chargers
- Other Handheld Devices

**Ordering Information**

PART NUMBER* (Note)	PART MARKING	TEMP. RANGE (°C)	VBAT (V)	VSEN	TEMP	TIMEOUT	PACKAGE (Pb-free)	PKG DWG. #
ISL9205IRZ	DLBA	-40 to +85	4.2	YES	YES	YES	16 Ld 3x3 QFN	L16.3x3B
ISL9205AIRZ	DLCA	-40 to +85	4.2	YES	NO	NO	10 Ld 3x3 DFN	L10.3x3
ISL9205BIRZ	DLDA	-40 to +85	4.2	YES	NO	YES	10 Ld 3x3 DFN	L10.3x3
ISL9205CIRZ	DLEA	-40 to +85	4.256	YES	NO	YES	10 Ld 3x3 DFN	L10.3x3
ISL9205DIRZ	DLFA	-40 to +85	4.2	NO	YES	YES	10 Ld 3x3 DFN	L10.3x3

\*Add "-T" suffix for tape and reel.

NOTE: Intersil Pb-free plus anneal products employ special Pb-free material sets; molding compounds/die attach materials and 100% matte tin plate termination finish, which are RoHS compliant and compatible with both SnPb and Pb-free soldering operations. Intersil Pb-free products are MSL classified at Pb-free peak reflow temperatures that meet or exceed the Pb-free requirements of IPC/JEDEC J STD-020.

**Pinouts**

**ISL9205  
(16 LD QFN)  
TOP VIEW**

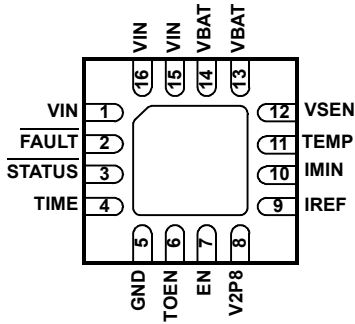

**ISL9205A, ISL9205B, ISL9205C  
(10 LD DFN)  
TOP VIEW**

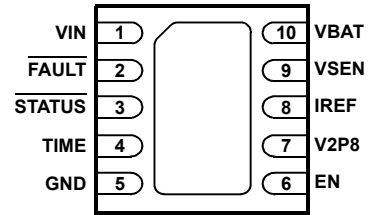

**ISL9205D  
(10 LD DFN)  
TOP VIEW**

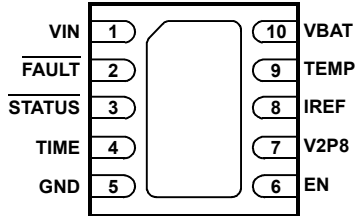

**Typical Applications**

**For 3x3 QFN Package Option**

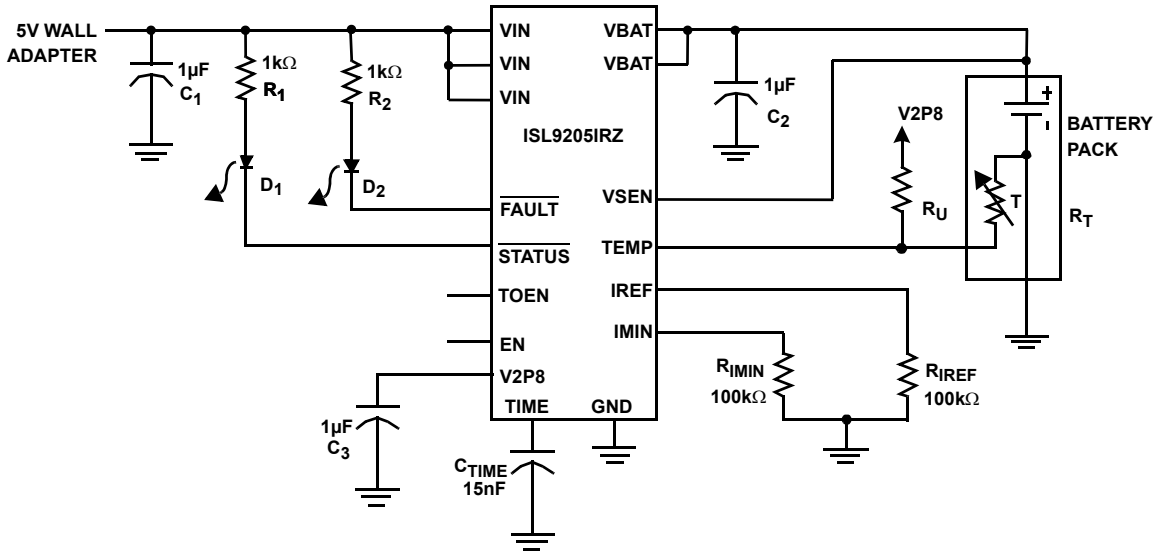

**For 3x3 DFN Package Option**

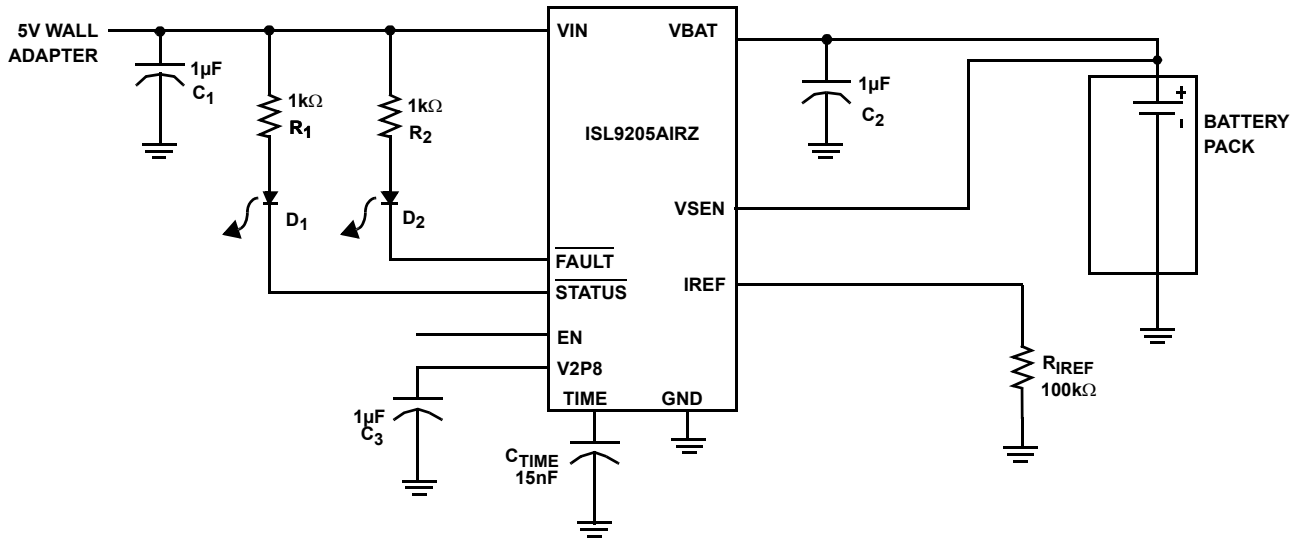

## Pin Description

### **VIN (Pin 1, 15, 16 for ISL9205; Pin 1 for ISL9205A, ISL9205B, ISL9205C and ISL9205D)**

VIN is the input power source. Connect to a wall adapter.

### **FAULT (Pin 2)**

$\overline{\text{FAULT}}$  is an open-drain output indicating fault status. This pin is pulled to LOW under any fault condition. When a fault condition occurs, the time counter will be reset. When the charger is disabled, the  $\overline{\text{FAULT}}$  pin outputs high impedance.

### **STATUS (Pin 3)**

STATUS is an open-drain output indicating charging and inhibit states. The STATUS pin is pulled LOW when the charger is charging a battery. It will be turned into high impedance when the charge current drops to I<sub>MIN</sub>. This high impedance state will be latched until a recharge cycle or a new charge cycle starts. When the charger is disabled, the STATUS pin outputs high impedance.

### **TIME (Pin 4)**

The TIME pin determines the oscillation period by connecting a timing capacitor between this pin and GND. The oscillator also provides a time reference for the charger.

### **GND (Pin 5)**

GND is the connection to system ground.

### **TOEN (Pin 6 for ISL9205; N/A for ISL9205A, ISL9205B, ISL9205C and ISL9205D)**

TOEN is the TIMEOUT enable input pin. Pulling this pin to LOW disables the TIMEOUT charge-time limit for the fast charge modes. Leaving this pin HIGH or floating enables the TIMEOUT limit. There is an internal 400k $\Omega$  pull-up resistor at this pin.

### **EN (Pin 7 for ISL9205; Pin 6 for ISL9205A, ISL9205B, ISL9205C and ISL9205D)**

EN is the enable logic input. Connect the EN pin to LOW to disable the charger or leave it floating to enable the charger. There is an internal 400k $\Omega$  pull-up resistor at this pin.

### **V2P8 (Pin 8 for ISL9205; Pin 7 for ISL9205A, ISL9205B, ISL9205C and ISL9205D)**

This is a 2.8V reference voltage output. This pin provides a 2.8V voltage source when the input voltage is above the POR threshold and outputs zero otherwise. The V2P8 pin can be used as an indication for adapter presence.

### **IREF (Pin 9 for ISL9205; Pin 8 for ISL9205A, ISL9205B, ISL9205C and ISL9205D)**

This is the charge current programming and monitoring pin. Connect a resistor between this pin and GND to set the charge current during the constant current phase, as given by Equation 1:

$$I_{\text{REF}} = \frac{80}{R_{\text{IREF}}} \quad (\text{A}) \quad (\text{EQ. 1})$$

Where R<sub>IREF</sub> is in k $\Omega$ .

### **IMIN (Pin 10 for ISL9205; N/A for ISL9205A, ISL9205B, ISL9205C and ISL9205D)**

IMIN is the end-of-charge (EOC) current programming pin. Connect a resistor between this pin and GND to set the EOC current, as given by Equation 2:

$$I_{\text{MIN}} = \frac{8000}{R_{\text{IMIN}}} \quad (\text{mA}) \quad (\text{EQ. 2})$$

Where R<sub>IMIN</sub> is in k $\Omega$ .

### **TEMP (Pin 11 for ISL9205; Pin 9 for ISL9205D; N/A for ISL9205A, ISL9205B and ISL9205C)**

TEMP is the input for an external NTC thermistor. The TEMP pin is also used for battery removal detection.

### **VSEN (Pin 12 ISL9205; Pin 9 for ISL9205A, ISL9205B and ISL9205C; N/A for ISL9205D)**

VSEN is the remote voltage sense pin. Connect this pin as close to the battery positive terminal as possible. If the VSEN pin is left floating, its voltage drops to zero volt and the charger operates in trickle mode.

### **VBAT (Pin 13, 14 for ISL9205; Pin 10 for ISL9205A, ISL9205B, ISL9205C and ISL9205D)**

VBAT is the connection to the battery. Typically a 10 $\mu\text{F}$  Tantalum capacitor is needed for stability when there is no battery attached. When a battery is attached, only a 0.1 $\mu\text{F}$  ceramic capacitor is required.

**Absolute Maximum Ratings**

Voltage Ratings for All Pins	-0.3V to 7V
Charge Current	1.0A
ESD Rating	
Human Body Model	.2kV
Machine Model	200V

**Thermal Information**

Thermal Resistance	$\theta_{JA}$ (°C/W)	$\theta_{JC}$ (°C/W)
3x3 DFN Package (Note 1)	48	6
3X3 QFN Package (Note 2)	54	6
Maximum Junction Temperature (Plastic Package)	+150°C	
Maximum Storage Temperature Range	-65°C to +150°C	
Maximum Lead Temperature (Soldering 10s)	+300°C	

**Recommended Operating Conditions**

Ambient Temperature Range	-40°C to +85°C
Operating Supply Voltage (VIN Pin)	4.25V to 6.5V
Programmed Charge Current	50mA to 900mA

*CAUTION: Stresses above those listed in "Absolute Maximum Ratings" may cause permanent damage to the device. This is a stress only rating and operation of the device at these or any other conditions above those indicated in the operational sections of this specification is not implied.*

*The 150°C maximum junction temperature is for information purposes only. In reality, the current foldback feature will prevent the junction from rising above a worst case temperature of 125°C.*

**NOTES:**

- $\theta_{JA}$  is measured in free air with the component mounted on a high effective thermal conductivity test board with "direct attach" features. See Tech Brief TB379.
- For  $\theta_{JC}$ , the "case temp" location is the center of the exposed metal pad on the package underside.

**Electrical Specifications**

Typical Values Are Tested at  $V_{IN} = 5V$  and the Ambient Temperature at +25°C. All Maximum and Minimum Values Are Guaranteed Under the Recommended Operating Supply Voltage Range and Ambient Temperature Range, Unless Otherwise Noted.

PARAMETER	SYMBOL	TEST CONDITIONS	MIN	TYP	MAX	UNITS
<b>POWER-ON RESET</b>						
Rising POR Threshold	$V_{POR}$	$V_{BAT} = 3.0V$ , use V2P8 pin to indicate the comparator output.	3.2	3.6	3.9	V
Falling POR Threshold	$V_{POR}$		2.25	2.5	2.7	V
<b>VIN-BAT OFFSET VOLTAGE</b>						
Rising Edge	$V_{OS}$	$V_{BAT} = 4.2V$ , $I_{BAT} = 20mA$ , use STATUS pin to indicate the comparator output (Note 3)	45	80	100	mV
<b>STANDBY CURRENT</b>						
BAT Pin Sink Current	$I_{STANDBY}$	Charger disabled or the input is floating	-	-	3.3	$\mu A$
VIN Pin Supply Current	$I_{VIN}$	Charger disabled	-	150	250	$\mu A$
VIN Pin Supply Current	$I_{VIN}$	Charger enabled	-	1.0	-	mA
<b>VOLTAGE REGULATION</b>						
Output Voltage (Except ISL9205C)	$V_{CH}$	Tested at 50mA load, 5V input, and +25°C	4.185	4.20	4.215	V
	$V_{CH}$	-40°C < $T_A$ < +85°C, 4.3V < $V_{IN}$ < 6.5V	4.175	4.20	4.225	V
Output Voltage (ISL9205C)	$V_{CH}$	Tested at 50mA load, 5V input, and +25°C	4.241	4.256	4.271	V
	$V_{CH}$	-40°C < $T_A$ < +85°C, 4.3V < $V_{IN}$ < 6.5V	4.231	4.256	4.281	V
PMOS ON-Resistance	$r_{DS(ON)}$	$V_{BAT} = 4.0V$ , charge current = 0.35A	-	500	-	$m\Omega$
<b>CHARGE CURRENT (Note 4)</b>						
Constant Charge Current	$I_{CC}$	$R_{IREF} = 100k\Omega$ , $V_{BAT} = 3.0V$ to 4.0V	760	800	840	mA
Trickle Charge Current	$I_{TRK}$	$R_{IREF} = 100k\Omega$ , $V_{BAT} = 0V$ to 2.5V	64	80	96	mA
End-of-Charge Current	$I_{MIN}$	$R_{IMIN} = 100k\Omega$ (ISL9205)	70	80	90	mA
End-of-Charge Current	$I_{MIN}$	$R_{IREF} = 100k\Omega$ (ISL9205A, ISL9205B, ISL9205C and ISL9205D)	70	80	90	mA
<b>V2P8 PIN OUTPUT</b>						
V2P8 Pin Output Voltage	$V_{V2P8}$	Load current less than 1mA	2.8	2.9	3.0	V

# ISL9205

**Electrical Specifications** Typical Values Are Tested at  $V_{IN} = 5V$  and the Ambient Temperature at  $+25^{\circ}C$ . All Maximum and Minimum Values Are Guaranteed Under the Recommended Operating Supply Voltage Range and Ambient Temperature Range, Unless Otherwise Noted. **(Continued)**

PARAMETER	SYMBOL	TEST CONDITIONS	MIN	TYP	MAX	UNITS
<b>CHARGE THRESHOLDS</b>						
Preconditioning Charge Threshold Voltage	$V_{MIN}$		2.7	2.8	2.9	V
Preconditioning Voltage Hysteresis	$V_{MINHYS}$		50	100	150	mV
Recharge Threshold	$V_{RCH}$	Referenced to the charger output voltage $V_{CH}$	-225	-150	-70	mV
Recharge Threshold Hysteresis	$V_{RCHHYS}$		-	50	-	mV
<b>INTERNAL TEMPERATURE MONITORING</b>						
Charge Current Foldback Threshold	$T_{FOLD}$		-	110	-	$^{\circ}C$
<b>AMBIENT TEMPERATURE MONITORING (ISL9205 and ISL9205D)</b>						
High Voltage Threshold		$V_{2P8} = 3.0V$	1.98	2.0	2.02	V
High Voltage Threshold Hysteresis		$V_{2P8} = 3.0V$	-	1.9	-	V
Low Voltage Threshold		$V_{2P8} = 3.0V$	0.99	1	1.01	V
Low Voltage Threshold Hysteresis		$V_{2P8} = 3.0V$	-	1.1	-	V
<b>OSCILLATOR</b>						
Oscillation Period	$t_{OSC}$	$C_{TIME} = 15nF$	2.7	3.0	3.3	ms
<b>LOGIC INPUT AND OUTPUTS</b>						
EN/TOEN Pin Logic Input High			1.3	-	-	V
EN/TOEN Pin Logic Input Low			-	-	0.5	V
EN/TOEN Pin Internal Pull Up Resistance			200	400	600	$k\Omega$
STATUS/FAULT Output Voltage When On		10mA current	-	-	0.8	V
STATUS/FAULT Leakage Current		$V_{STATUS} = 6.5V$	-	-	1	$\mu A$

**NOTE:**

- The 4.2V  $V_{BAT}$  is selected so that the  $\overline{STATUS}$  output can be used as the indication for the offset comparator output indication. If the  $V_{BAT}$  is lower than the POR threshold, no output pin can be used for indication.
- The charge current can be affected by the thermal foldback function if the IC under the test setup cannot dissipate the heat.

**Typical Operating Performance**

The test conditions for the Typical Operating Performance are:  $V_{IN} = 5V$ ,  $T_A = +25^{\circ}C$ ,  $R_{IREF} = R_{IMIN} = 100k\Omega$ ,  $V_{BAT} = 3.7V$ , Unless Otherwise Noted

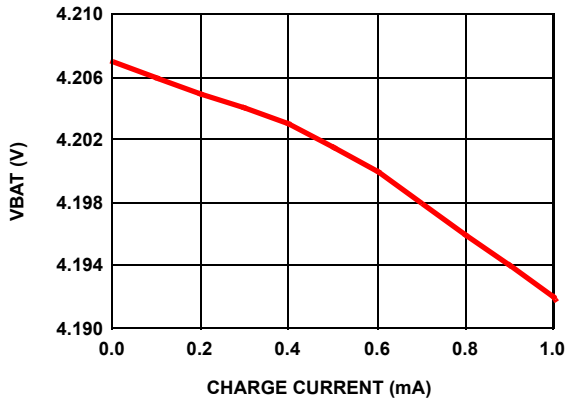

FIGURE 1. CHARGER OUTPUT VOLTAGE vs CHARGE CURRENT

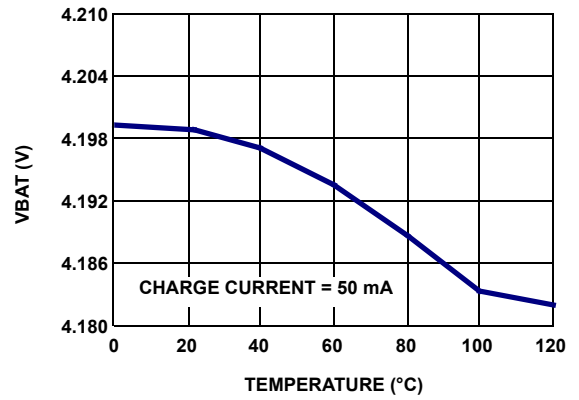

FIGURE 2. CHARGER OUTPUT VOLTAGE vs TEMPERATURE

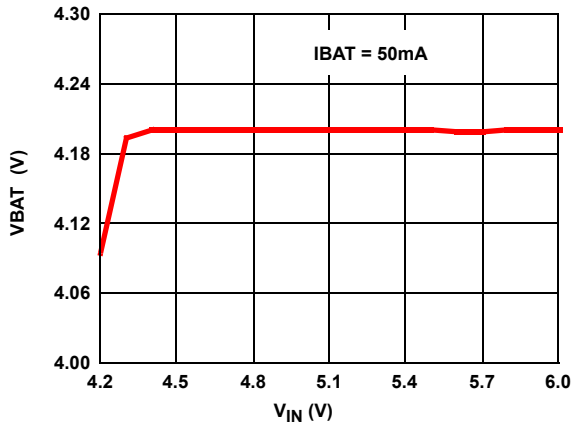

FIGURE 3. CHARGER OUTPUT VOLTAGE vs INPUT VOLTAGE CHARGE CURRENT IS 50mA

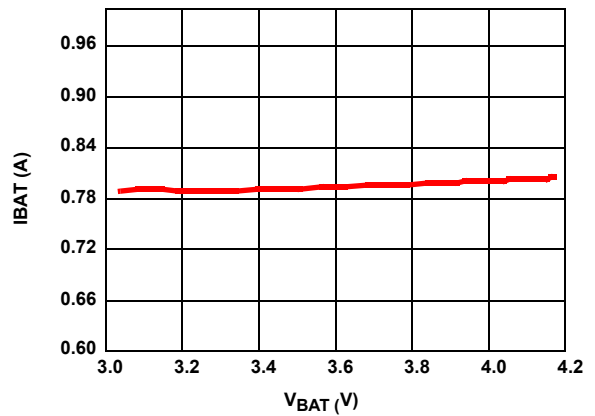

FIGURE 4. CHARGE CURRENT vs OUTPUT VOLTAGE

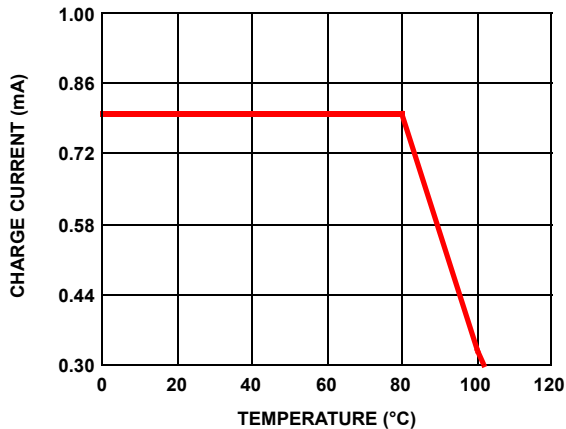

FIGURE 5. CHARGE CURRENT vs AMBIENT TEMPERATURE

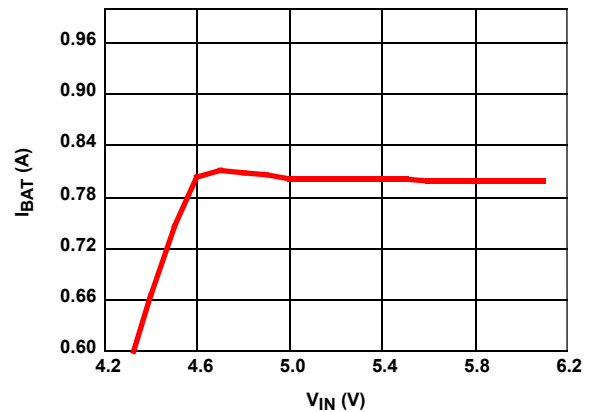

FIGURE 6. CHARGE CURRENT vs INPUT VOLTAGE

**Typical Operating Performance**

The test conditions for the Typical Operating Performance are:  $V_{IN} = 5V$ ,  $T_A = +25^{\circ}C$ ,  $R_{IREF} = R_{IMIN} = 100k\Omega$ ,  $V_{BAT} = 3.7V$ , Unless Otherwise Noted **(Continued)**

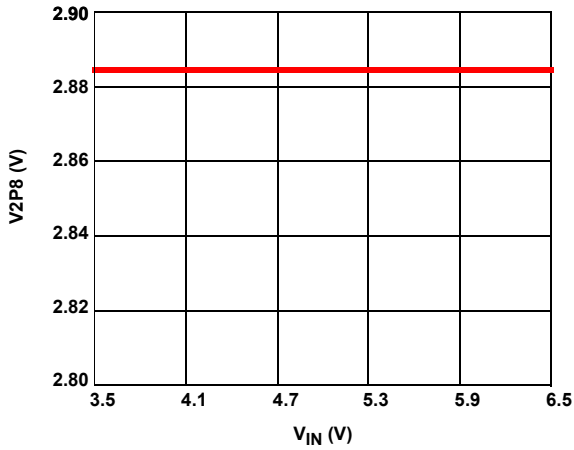

FIGURE 7. V2P8 OUTPUT vs INPUT VOLTAGE

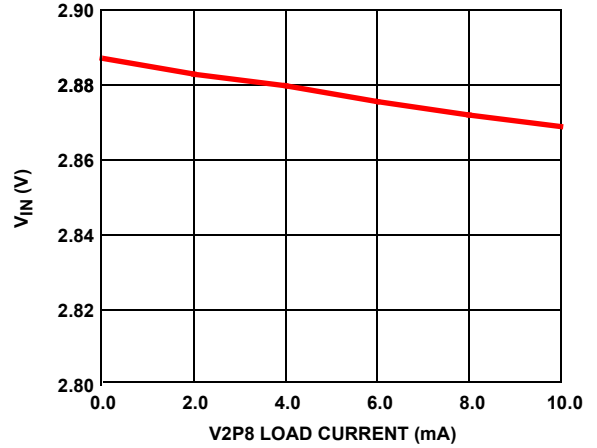

FIGURE 8. V2P8 OUTPUT vs ITS LOAD CURRENT

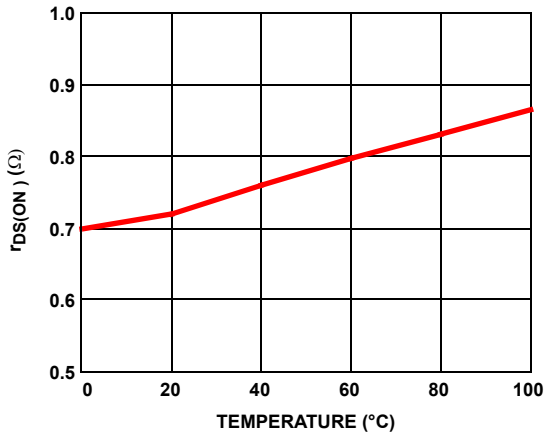

FIGURE 9.  $r_{DS(ON)}$  vs TEMPERATURE AT 3.7V OUTPUT

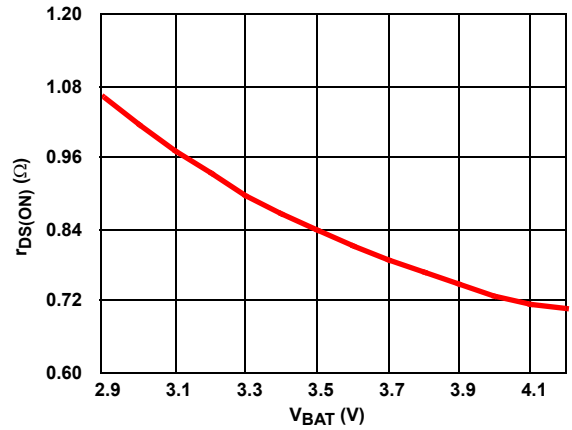

FIGURE 10.  $r_{DS(ON)}$  vs OUTPUT VOLTAGE USING CURRENT LIMITED ADAPTERS

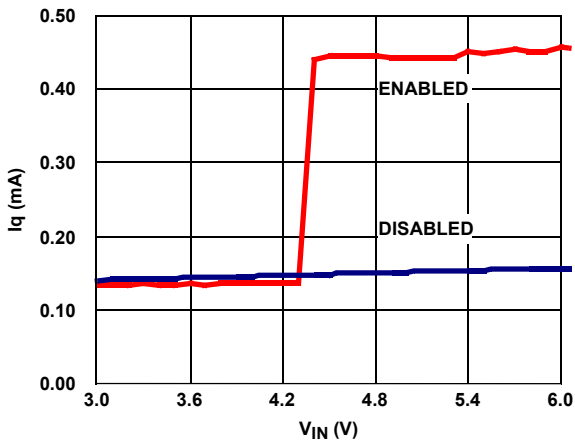

FIGURE 11. INPUT QUIESCENT CURRENT vs INPUT VOLTAGE

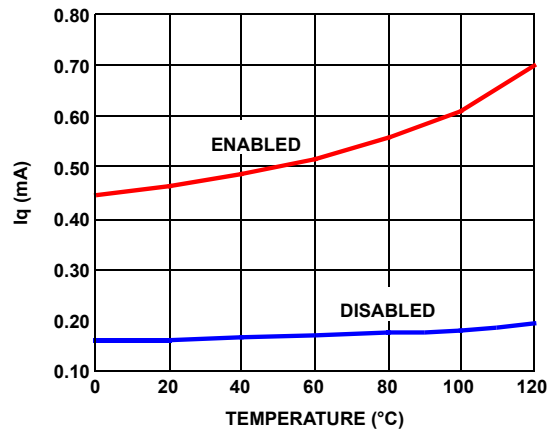

FIGURE 12. INPUT QUIESCENT CURRENT vs TEMPERATURE





During the constant voltage phase, the charge current reduces gradually as the cell voltage rises.

### End-of-Charge and Recharge

As the charge current reaches the EOC (end-of-charge) current threshold during the constant voltage phase, the  $\overline{\text{STATUS}}$  pin open-drain FET is turned off to indicate an EOC condition. The EOC current is programmable for the ISL9205 by connecting a resistor from the IMIN pin to GND. For others, the EOC current is fixed at 10% of the programmed constant charge current. When the  $\overline{\text{STATUS}}$  pin indicates the EOC condition, the charger will continue to charge until the EN pin is pulled to logic LOW or the input power has been removed. After EOC is reached, recharge will occur when the battery voltage falls to 150mV below the constant voltage value. The  $\overline{\text{STATUS}}$  open-drain FET is turned on when a recharge condition is met. An internal delay is implemented at the  $\overline{\text{STATUS}}$  pin for both EOC and recharge conditions to prevent nuisance trips due to noise and fast load current transitions. The delay time is approximately one clock cycle (varies between 0.5 and 1.5 clock) of the internal oscillator, which is programmed by the timer capacitor. The typical charge waveforms in Figure 13 show the complete cycle operation.

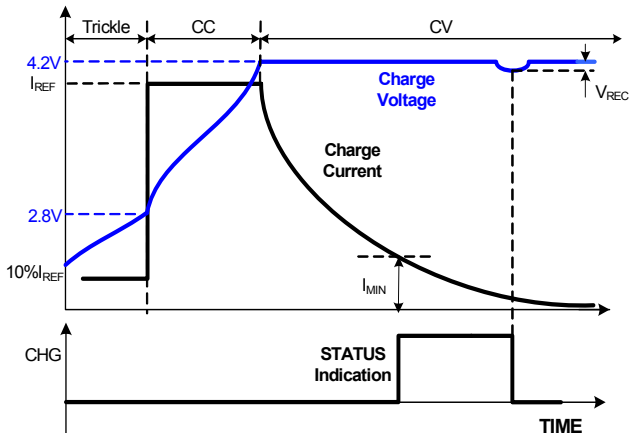

FIGURE 13. TYPICAL CHARGE CYCLE WITH TIMEOUT

### Temperature Monitoring and Thermal Foldback

In the event where the die temperature reaches the thermal foldback threshold (+110°C typical), the charge current is reduced accordingly to prevent further temperature rise. In the ISL9205 and ISL9205D versions, there is an external temperature monitoring function. A negative temperature coefficient (NTC) thermistor can be connected between the TEMP pin and GND to monitor the battery temperature or ambient temperature. The hysteresis comparators internal to the ISL9205 provide a valid temperature window centered at the voltage of the TEMP pin, which is programmed by the NTC and the pull-up resistor connected to the pin. When the measured temperature is outside this window, the charger is paused (both the charger and the timer are stopped) and a fault indication is issued. If the thermistor is attached to the

battery, the TEMP function can be used to discover a battery removal condition when the TEMP pin voltage is much higher than the reference threshold.

### POR

The power-on reset (POR) function monitors the supply voltage. The POR has a rising edge threshold of 3.6V typical and 2.5V typical for falling edge. The charger is expected to operate when the input voltage is above the POR threshold. After POR the charger will continue to operate for supply voltage down to 2.5V typical. It is also required that the supply voltage be higher than the VBAT pin voltage by a typical 80mV for the charger to function.

### Oscillator, TIMEOUT, and Charge Cycle

The ISL9205 incorporates with an oscillation circuit using an external timing capacitor connected to the TIME pin. The oscillator sets the limit for the maximum charge time during the trickle mode and the fast mode (CC and CV). The maximum charge time (TIMEOUT) for the fast mode is set by:

$$\text{TIMEOUT} = 2^{22} t_{\text{OSC}}$$

where the  $t_{\text{OSC}}$  is the oscillator period. The minimum programmable  $t_{\text{OSC}}$  is 20 $\mu\text{s}$  ( $C_{\text{TIME}} = 100\text{pF}$ ). The time limit for the trickle charge is 1/8 of the fast mode time limit. In the ISL9205, the time-out function can be disabled by pulling the TOEN pin to logic LOW. When TIMEOUT is disabled, the charger will never be turned off in constant current and constant voltage modes. For the ISL9205B and the ISL9105D, the timeout function is always enforced. For the ISL9105A, there is not timeout function.

A charge cycle is the time interval between the time when the charger is enabled to the moment it is disabled. If the battery voltage is lower than the trickle charge threshold at the time the charger is enabled, the charger enters the trickle mode and the timer is reset and its limit is set to 1/8 of TIMEOUT. If the timeout function is enabled, the charger will stop and indicate a TIMEOUT fault if the charge time is longer than the limit. If the trickle mode completes successfully before the time limit, the charger moves to CC mode and the timer is reset and the time limit is set to TIMEOUT. The charger needs to reach the EOC conditions before the TIMEOUT interval elapsed, otherwise, a TIMEOUT fault will be issued. The charger indicates the EOC with the  $\overline{\text{STATUS}}$  pin but does not terminate charging.

### Disabling TIMEOUT with TOEN

In the ISL9205, the time-out function in fast charge state (CC/CV) can be disabled by pulling the TOEN pin to logic LOW. The timeout function for the trickle charge mode can not be disabled. Note that in the ISL9205A, there is no timeout function for both the trickle and the CC/CV intervals whereas in the ISL9205 with TOEN set pulled to LOW, there is no timeout for the CC/CV interval but the timeout function for the trickle interval is still enforced.

### **Indications**

The ISL9205 has two open-drain status indication pins. These two pins are `FAULT` and `STATUS`. These pins require an external pull-up resistor to function properly. The `V2P8` pin can be used as the presence of AC adapter.

### **Charger Disable**

The `EN` pin allows the user to disable the charger. When the charger is disabled, all internal circuits are shut down and the quiescent current at the input pin is less than a typical value of 150mA.

### **Remote Battery Voltage Sensing**

In the ISL9205 and the ISL9205A, ISL9205B and ISL9205C versions, a kelvin sense pin is provided for battery terminal voltage monitoring. Thus, the IR drop due to the connection leads and PCB traces can be eliminated, resulting a more accurate battery voltage monitoring, especially when the battery is located at a significant distance away from the ISL9205. If remote sensing is not needed, the `VSEN` pin can be connected to `VBAT` at the IC.

## **Applications Information**

### **PCB Layout Guidance**

The ISL9205 uses a thermally-enhanced QFN/DFN packages that has an exposed thermal pad at the bottom side of the package. The layout should connect as much as possible to copper on the exposed pad. Typically the component layer is more effective in dissipating heat. The thermal impedance can be further reduced by using other layers of copper connecting to the exposed pad through a thermal via array. A minimum of four (4) such thermal vias are recommended. Each thermal via is recommended to have 0.3mm diameter and 0.7mm distance from other thermal vias.

### **Stability Consideration**

The ISL9205 should behave like a current and thermal limited linear regulator. The charger operation is stable with an output ceramic decoupling capacitor in the range of 1 $\mu$ F to 200 $\mu$ F, with or without a battery connected.

### **Input Bypass Capacitor**

Due to the inductance of the power leads of the wall adapter or USB source, the input capacitor type must be properly selected to prevent high voltage transient during a hot-plug event. A tantalum capacitor is a good choice for its high ESR, providing damping to the voltage transient. Multi-layer ceramic capacitors, however, have a very low ESR and hence when chosen as input capacitor, a 1 $\Omega$  series resistor must be used, as shown in the "Typical Applications" on page 3, to provide adequate damping.

### **State Machine Diagram**

The state machine diagram is shown in Figure 14. The diagram starts with the Power-Off state. When the input voltage rises above the POR threshold, the charger resets itself. Then, if the charger is disabled, the charger stays in the Charger Disabled state. If the charger is enabled, the trickle charge starts. Anytime when entering the trickle charge state, the internal `TIMEOUT` timer is reset. There are two paths to exit the trickle charge, one is when the battery voltage rises above the preconditioning charge threshold within the 1/8 `TIMEOUT` interval and the other is when the 1/8 `TIMEOUT` interval has been elapsed before reaching the preconditioning charge voltage threshold. When `TIMEOUT` fault occurs, the charger enters the `TIMEOUT` fault state. There are only two ways to exit the `TIMEOUT` fault state, by toggling the `EN` input or re-cycling the input power. If the charger finishes the trickle charger before the 1/8 `TIMEOUT` limit, it moves to the fast charge state. When entering the fast charge state, the `TIMEOUT` timer is reset as well. If the charger hits EOC conditions before the `TIMEOUT`, the charger enters Charge Compete state. The charger stays on but the `STATUS` indicates EOC condition. When `VBAT` drops below the recharge threshold, the `STATUS` pin will turn to logic low to indicate charging again.

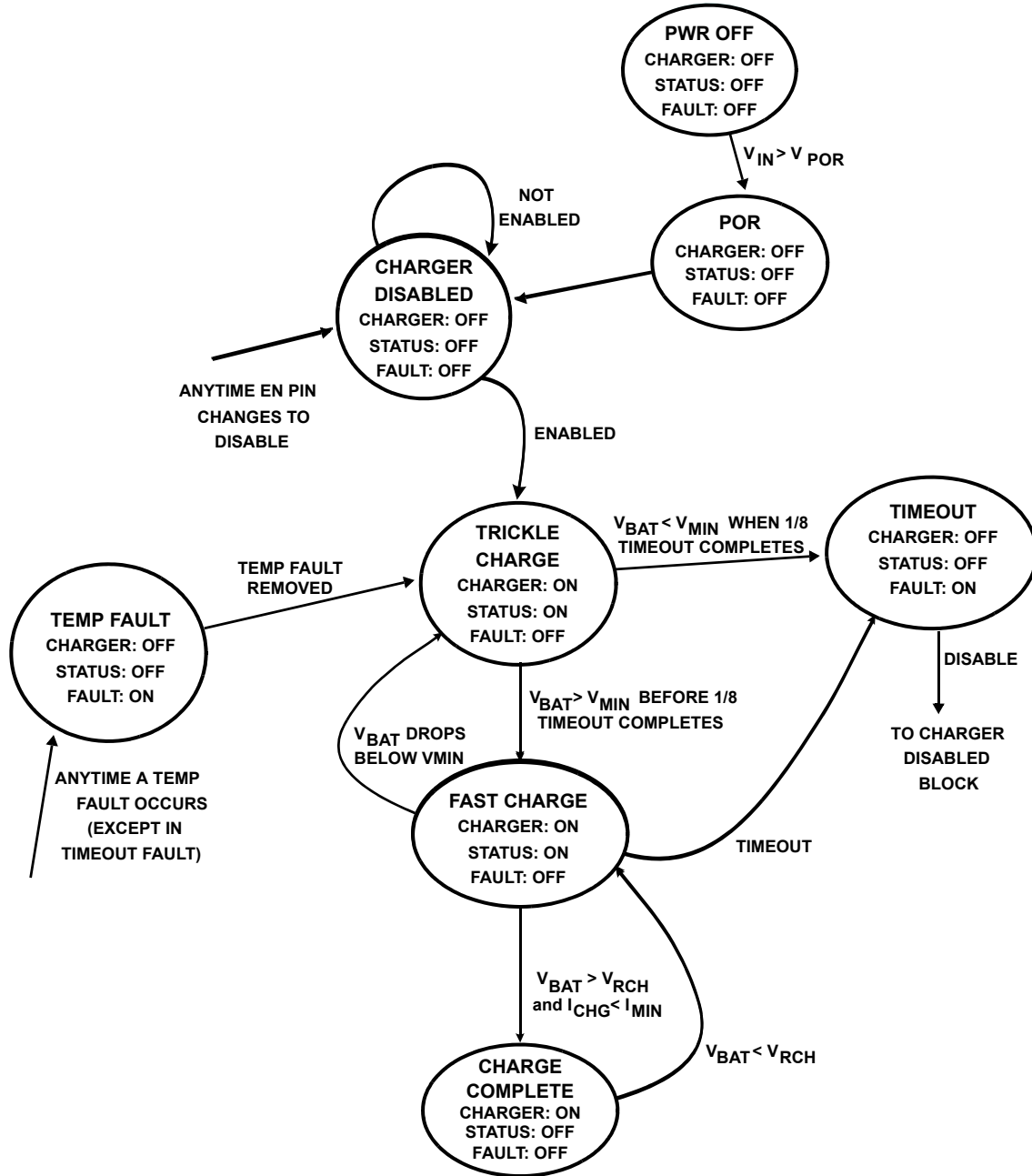

FIGURE 14. STATE MACHINE DIAGRAM

All Intersil U.S. products are manufactured, assembled and tested utilizing ISO9000 quality systems. Intersil Corporation's quality certifications can be viewed at [www.intersil.com/design/quality](http://www.intersil.com/design/quality)

*Intersil products are sold by description only. Intersil Corporation reserves the right to make changes in circuit design, software and/or specifications at any time without notice. Accordingly, the reader is cautioned to verify that data sheets are current before placing orders. Information furnished by Intersil is believed to be accurate and reliable. However, no responsibility is assumed by Intersil or its subsidiaries for its use; nor for any infringements of patents or other rights of third parties which may result from its use. No license is granted by implication or otherwise under any patent or patent rights of Intersil or its subsidiaries.*

For information regarding Intersil Corporation and its products, see [www.intersil.com](http://www.intersil.com)

# Package Outline Drawing

## L16.3x3B

16 LEAD QUAD FLAT NO-LEAD PLASTIC PACKAGE

Rev 1, 4/07

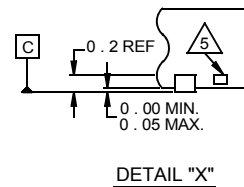
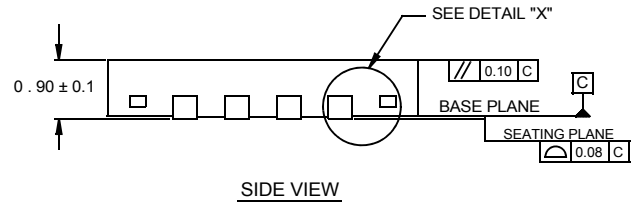
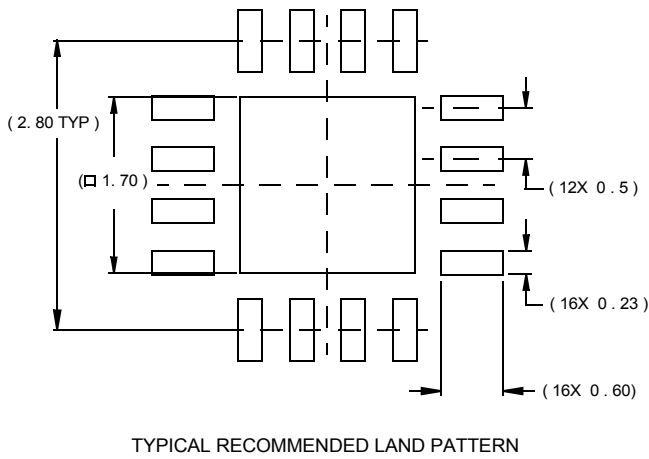
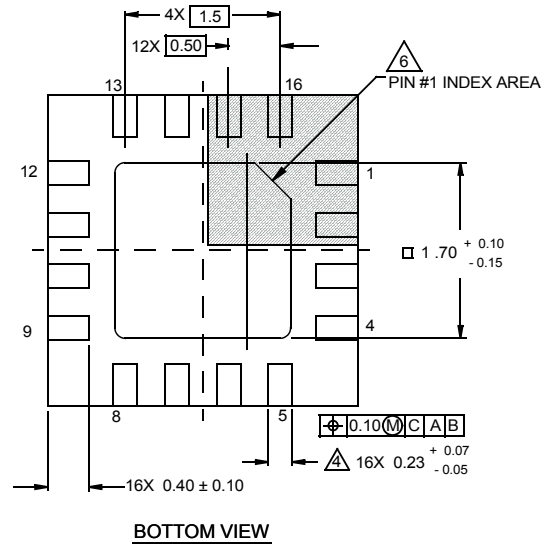
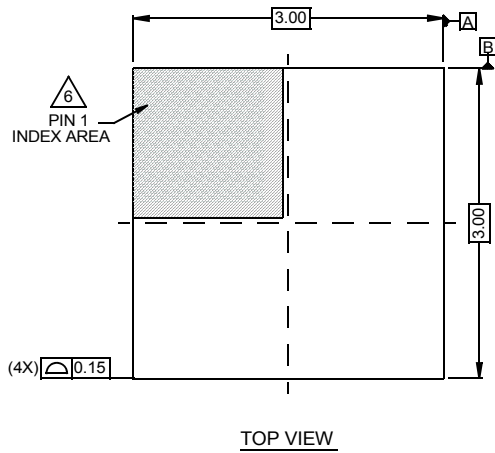

NOTES:

1. Dimensions are in millimeters.  
Dimensions in ( ) for Reference Only.
2. Dimensioning and tolerancing conform to AMSE Y14.5m-1994.
3. Unless otherwise specified, tolerance : Decimal ± 0.05
4. Dimension b applies to the metallized terminal and is measured between 0.15mm and 0.30mm from the terminal tip.
5. Tiebar shown (if present) is a non-functional feature.
6. The configuration of the pin #1 identifier is optional, but must be located within the zone indicated. The pin #1 identifier may be either a mold or mark feature.

# Package Outline Drawing

## L10.3x3

10 LEAD DUAL FLAT PACKAGE (DFN)

Rev 6, 09/09

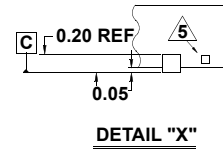
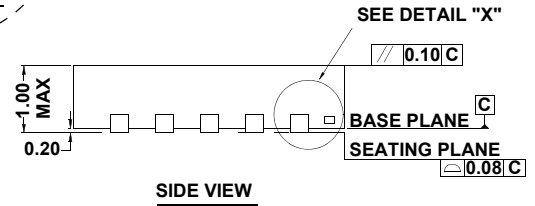
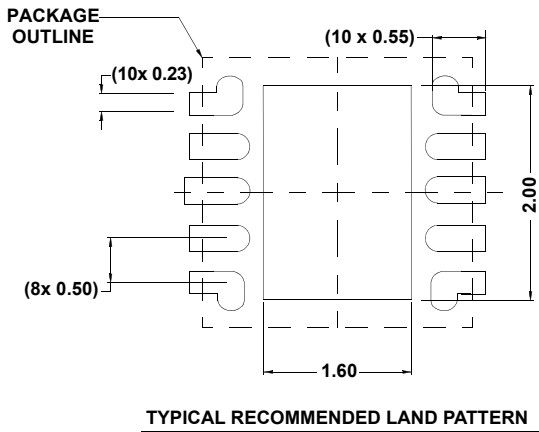
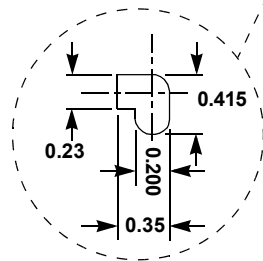
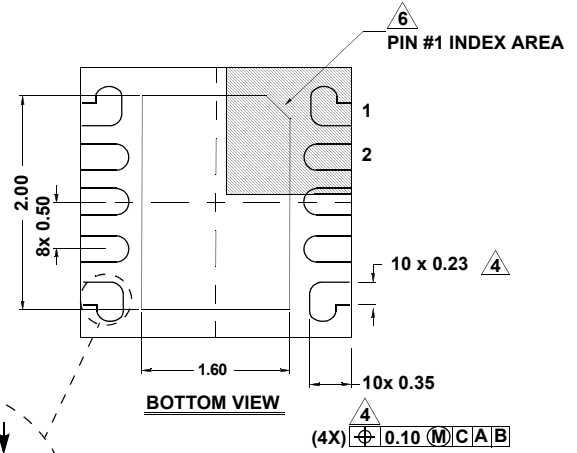
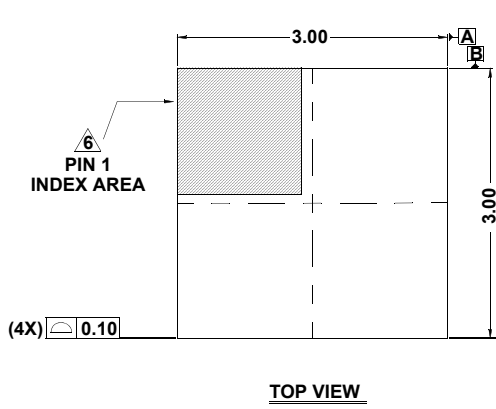

**NOTES:**

1. Dimensions are in millimeters.  
Dimensions in ( ) for Reference Only.
2. Dimensioning and tolerancing conform to AMSE Y14.5m-1994.
3. Unless otherwise specified, tolerance : Decimal  $\pm 0.05$
4. Lead width applies to the metallized terminal and is measured between 0.18mm and 0.30mm from the terminal tip.
5. Tiebar shown (if present) is a non-functional feature.
6. The configuration of the pin #1 identifier is optional, but must be located within the zone indicated. The pin #1 identifier may be either a mold or mark feature.