

BT09AG



5-4000 MHz Wideband Medium Power Amplifier

Device Features

- OIP3 = 43.0 dBm @ 900 MHz
- Gain = 20.0 dB @ 900 MHz
- Output P1 dB = 24.5 dBm @ 900 MHz
- 50 Ω Cascadable
- Lead-free/RoHS-compliant SOT-89 SMT package



Product Description

BeRex's BT09AG is a high performance and a high dynamic range amplifier in a low cost surface mount package(SOT-89) with a RoHS-compliant, that incorporates reliable heterojunction-bipolar-transistor (HBT) devices fabricated with InGaP GaAs technology. This device is designed for use where high linearity is required and features high OIP3 and P1 with low consumption current (85mA) and requires a few external matching components such as a DC blocking capacitors on the In/Output pin, a bypass capacitor and a RF choke for the out port. All devices are 100% RF/DC tested.

Applications

- Base station Infrastructure/RFID
- Commercial/Industrial/Military wireless system

Application Circuits

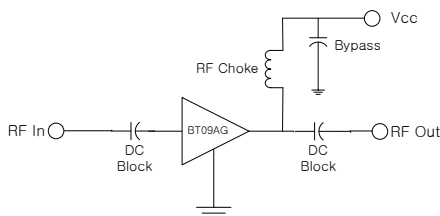

*external matching circuit: refer to the page 5 to 13.

Typical Performance¹

Parameter	Frequency				Unit
	900	1900	2450	3500	
Gain	20.0	14.5	12.5	9.20	dB
S11	-17.0	-22.0	-16.0	-17.0	dB
S22	-14.0	-16.0	-24.0	-23.0	dB
OIP3 ²	43.0	43.0	43.0	39.0	dBm
P1dB	24.5	24.2	26.0	25.8	dBm
Noise Figure	4.2	4.2	4.3	5.0	dB

¹ Device performance _ measured on a BeRex evaluation board at 25°C, 50 Ω system.

² OIP3 _ measured with two tones at an output of 14 dBm per tone separated by 1 MHz.

	Min.	Typical	Max.	Unit
Bandwidth	5		4000	MHz
I _C @ (V _C = 5V)	140	160	180	mA
V _C		5.0		V
R _{TH}		50		°C/W

Absolute Maximum Ratings

Parameter	Rating	Unit
Operating Case Temperature	-40 to +85	°C
Storage Temperature	-55 to +155	°C
Junction Temperature	+220	°C
Operating Voltage	+7.0	V
Supply Current	220	mA
Input RF Power	23	dBm

*Operation of this device above any of these parameters may result in permanent damage.

BT09AG

5-4000 MHz Wideband Medium Power Amplifier



V-I Characteristics

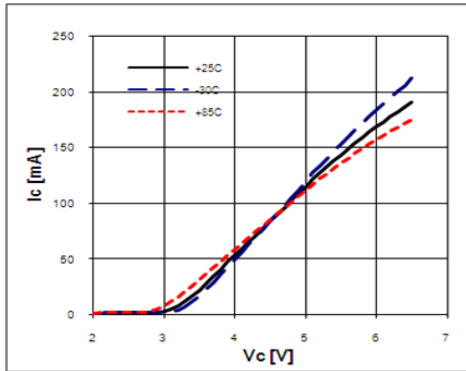

BeRex SOT89 Evaluation Board

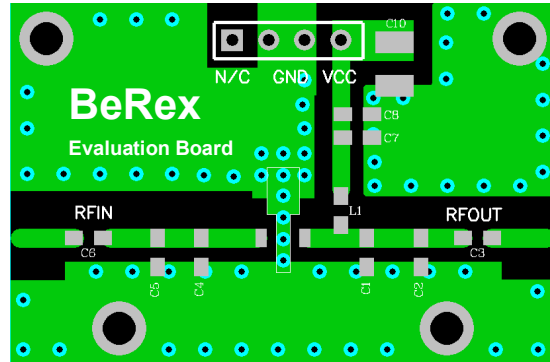

*Dielectric constant_ 4.2 *RF pattern width 52mil *31mil thick FR4 PCB

Typical Device Data

S-parameters (Vc=5V, Ic=162mA, T=25°C)

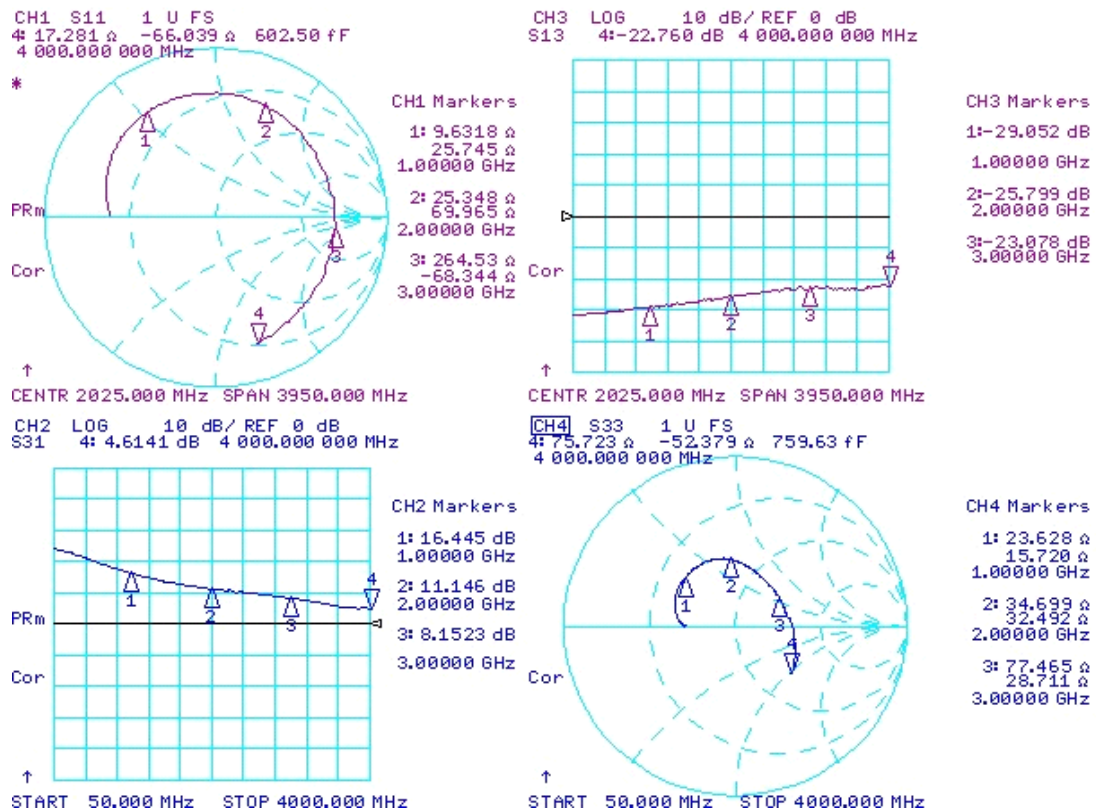

BT09AG

5-4000 MHz Wideband Medium Power Amplifier



S-Parameter

(Vdevice = 5.0V, Icc = 162mA, T = 25 °C, calibrated to device leads)

Freq [MHz]	S11 dB	S11 Ang	S21 dB	S21 Ang	S12 dB	S12 Ang	S22 dB	S22 Ang
100	-4.07	176.11	23.805	162.696	-31.49	0.3816	-10.62	179.54
500	-3.168	154.36	20.639	108.6	-30.63	2.108	-8.770	164.09
1000	-2.660	124.21	16.421	66.7556	-29.14	-3.335	-7.815	137.25
1500	-2.673	95.30	13.291	37.077	-27.53	-12.30	-7.601	115.23
2000	-2.835	66.61	11.151	9.186	-25.83	-22.90	-8.033	94.350
2500	-3.238	32.55	9.711	-19.52	-24.37	-40.16	-9.343	70.088
3000	-3.108	-5.552	8.137	-49.49	-23.08	-63.43	-10.36	33.584
3500	-2.733	-42.25	6.121	-78.61	-23.30	-84.36	-9.213	-8.5102
4000	-2.13	-71.93	4.604	-100.97	-22.79	-104.55	-7.32	-41.052

Typical Performance (Vd = 5V, Ic = 162mA, T = 25°C)

Freq	MHz	70	170	240	500	900	1900	2450
S21	dB	24.7	25	24.8	23	20.0	14.5	12.5
S11	dB	-18	-19	-20	-17	-17	-22	-16
S22	dB	-18	-16	-26	-16	-14	-16	-24
P1	dBm	24.5	25.5	25	24.5	24.5	24.2	26
OIP3	dBm	39	40	40	41.5	43	43	43
NF	dB	3.7	3.8	3.9	3.8	4.2	4.2	4.3

BT09AG

5-4000 MHz Wideband Medium Power Amplifier



WCDMA 6FA 2140 -55dBc

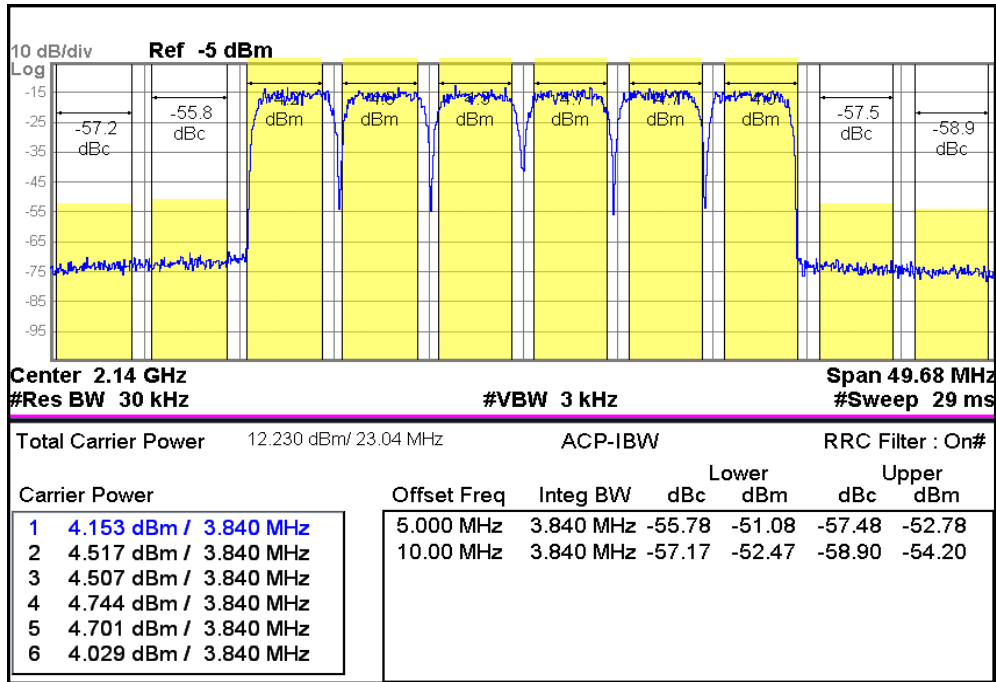

WCDMA 6FA 2140 -60dBc

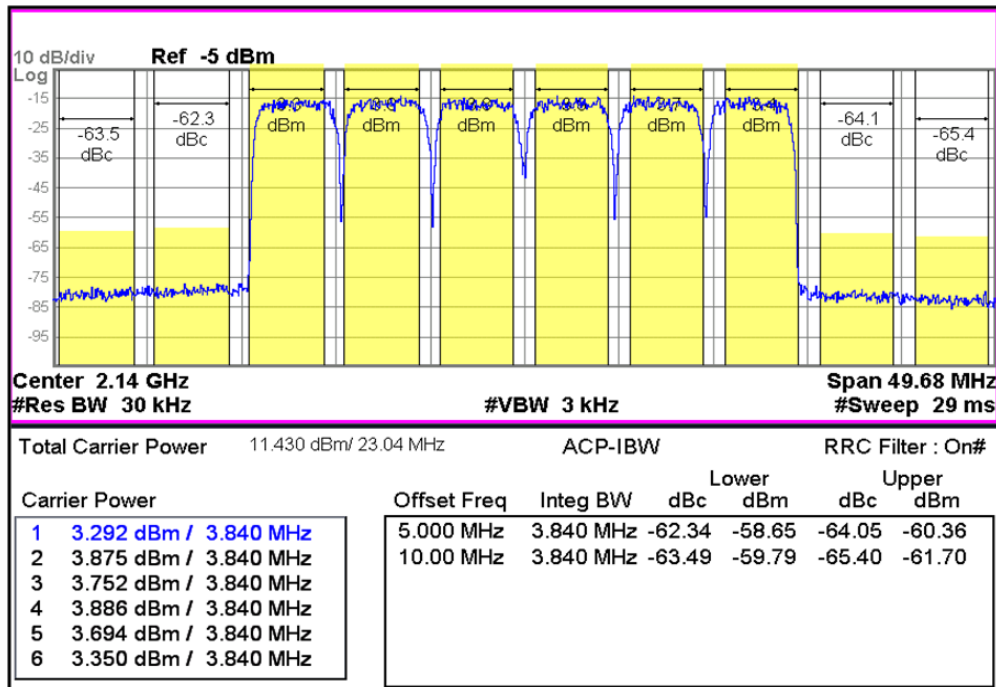

BT09AG

5-4000 MHz Wideband Medium Power Amplifier



ACLR

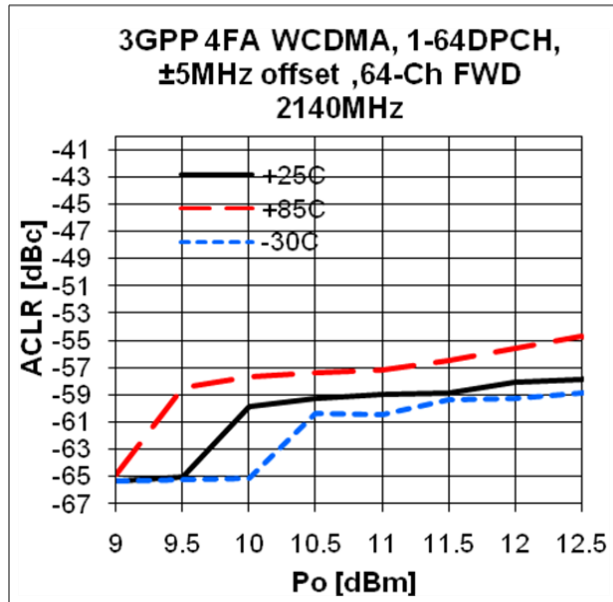

Application Circuit: 70~500 MHz

Schematic Diagram	BOM	70MHz	170MHz	240MHz	500MHz
	C1	100pF	100pF	100pF	100pF
	C2	100pF	100pF	100pF	100pF
	C3	10uF	10uF	10uF	10uF
	C4	8200pF	8200pF	8200pF	8200pF
	C5	8200pF	8200pF	8200pF	8200pF
	C6	86pF	33pF	22pF	10pF
	L1	330nH	100nH	100nH	100nH
	L2	47nH	18nH	12nH	4.7nH

BT09AG

5-4000 MHz Wideband Medium Power Amplifier



Typical Performance

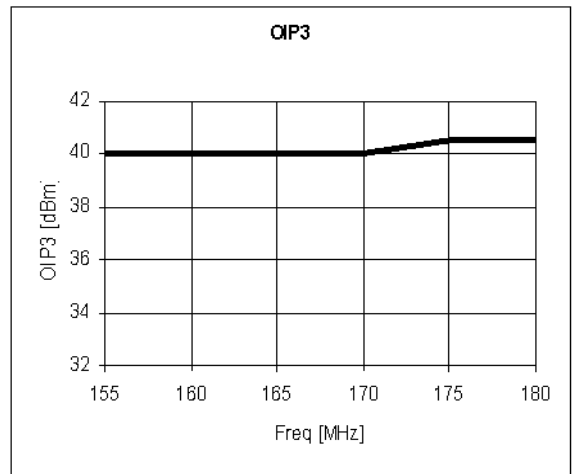
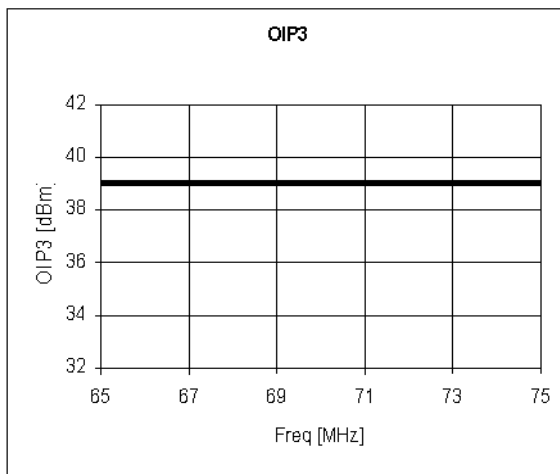
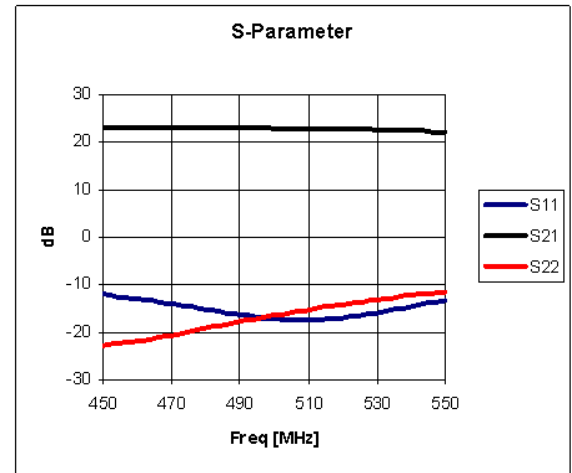
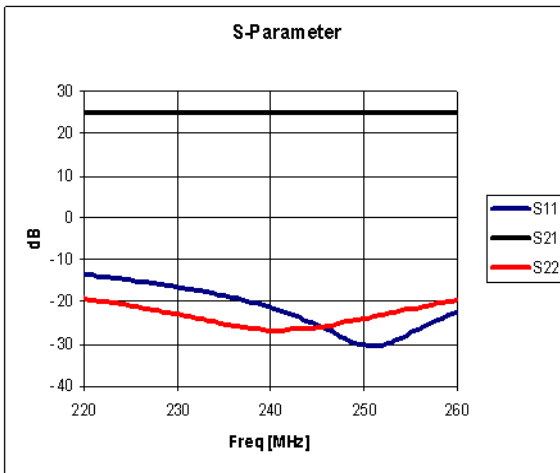
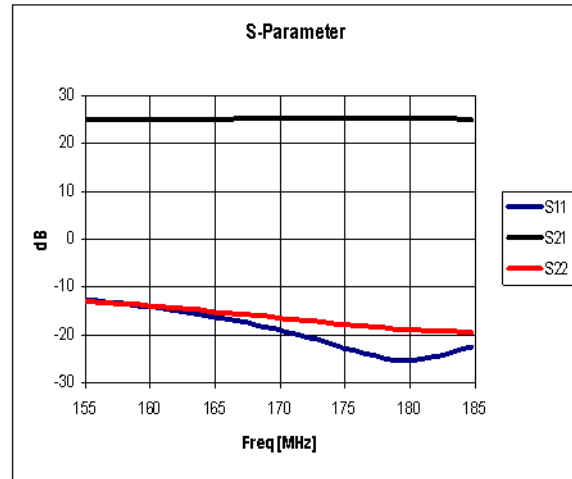
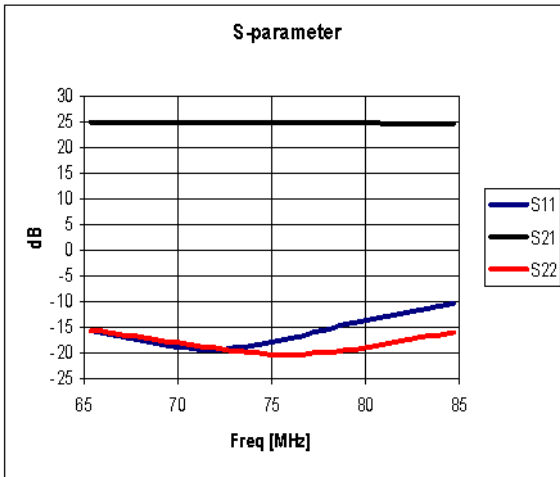

BT09AG

5-4000 MHz Wideband Medium Power Amplifier

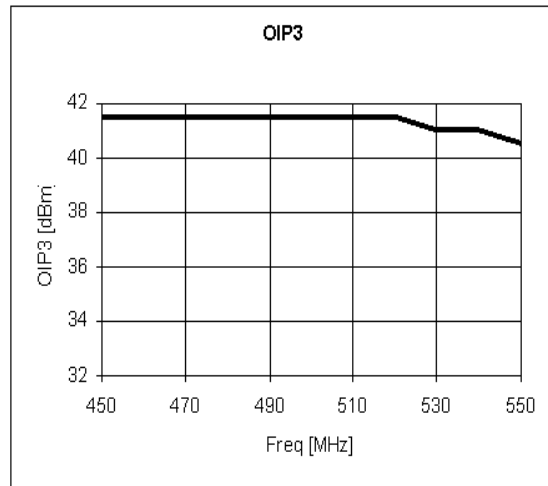
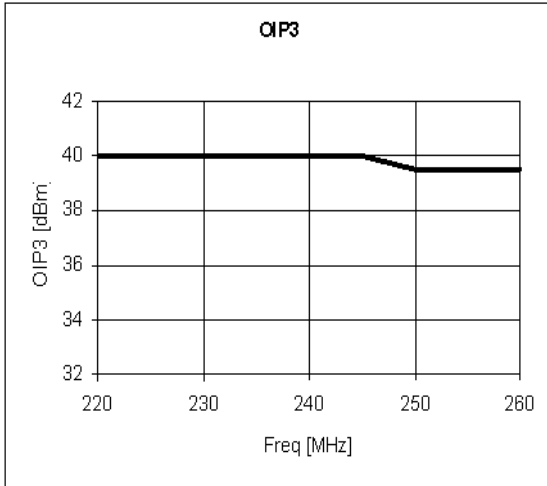

Application Circuit: 900 MHz

Schematic Diagram	BOM	Tolerance	
	C1	100pF	±5%
	C2	1000pF	±5%
	C3	10uF	±20%
	C4	100pF	±5%
	C5	100pF	±5%
	C6	8pF	±5%
	C7	10pF	±5%
	L1	39nH	±5%
	L2	1.8nH	±5%
	L3	6.8nH	±5%

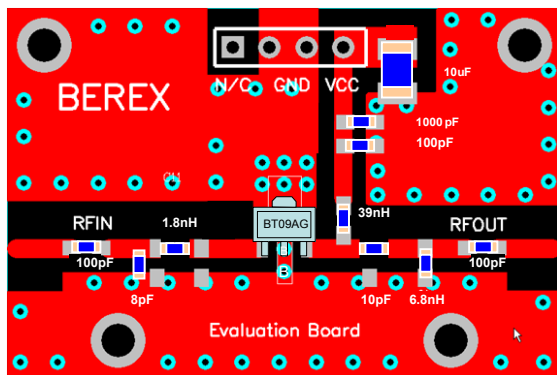

Note: 1. PCB: 31mil thick FR4.

- Distance between the center of the series inductor (L2) and the input pin of BT09AG _ **2.5mm.**
- Distance between the center of the shunt cap(C6) and the input pin of BT09AG _ **3.5mm.**
- Distance between the center of the series cap(C7) and the output pin of BT09AG _ **3.5mm.**
- Distance between the center of the shunt inductor (L3) and the output pin of BT09AG _ **6.0mm.**

BT09AG

5-4000 MHz Wideband Medium Power Amplifier



Typical Performance

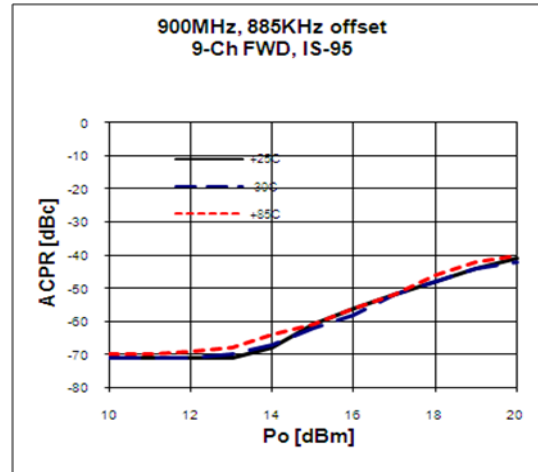
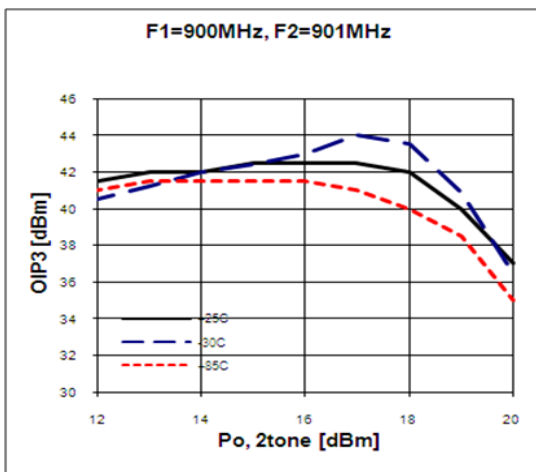
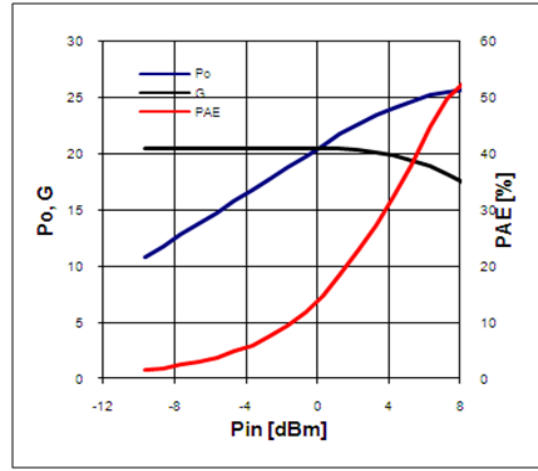
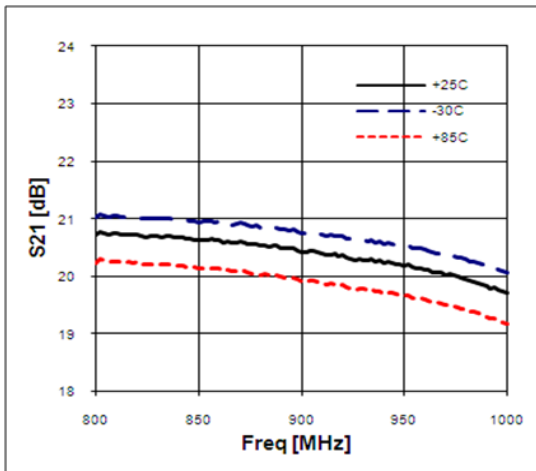
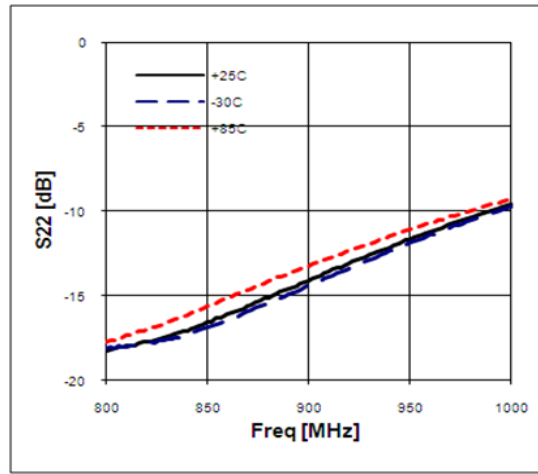
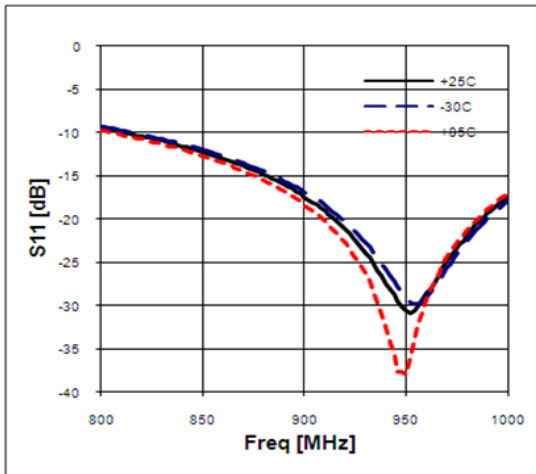

BT09AG

5-4000 MHz Wideband Medium Power Amplifier



Application Circuit: 1900MHz

Schematic Diagram	BOM	Tolerance	
	C1	100pF	±5%
	C2	1000pF	±5%
	C3	10uF	±20%
	C4	100pF	±5%
	C5	100pF	±5%
	C6	2pF	±5%
	C7	1.2pF	±5%
	L1	39nH	5%
L2	1.2nH	2%	

Note:
1. PCB: 31mil thick FR4.
2. Distance between the center of the shunt cap(C6) and the input pin of BT09AG _ 1.0mm .
3. Distance between the center of the series inductor(L2) and the output pin of BT09AG _ 3.5mm .
4. Distance between the center of the shunt cap(C7) and the output pin of BT09AG _ 7.2mm .

Typical Performance

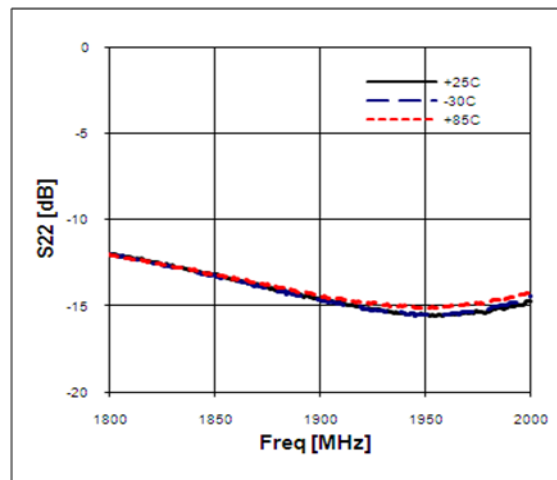
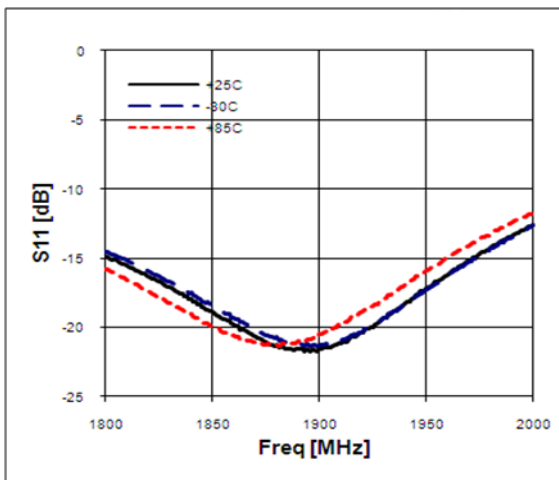

BT09AG

5-4000 MHz Wideband Medium Power Amplifier

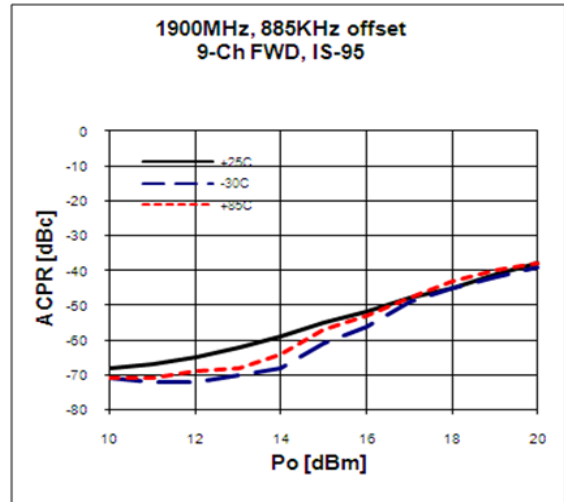
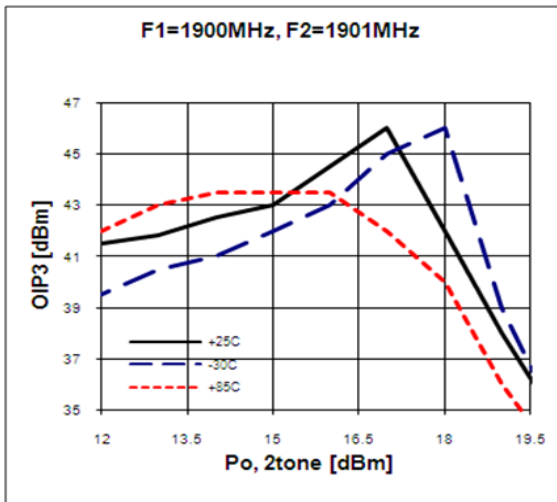
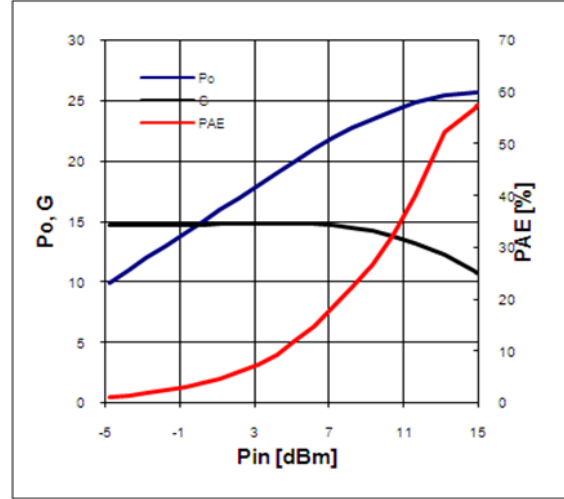
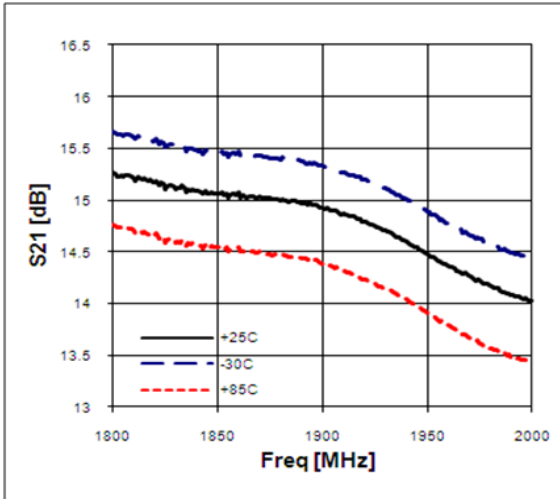

BT09AG

5-4000 MHz Wideband Medium Power Amplifier



Application Circuit: 2450MHz

Schematic Diagram		BOM	Tolerance
	C1	100pF	±5%
	C2	1000pF	±5%
	C3	10uF	±20%
	C4	100pF	±5%
	C5	100pF	±5%
	C6	1pF	±5%
	C7	2.5pF	±5%
	C8	0.5pF	±5%
L1	39nH	5%	

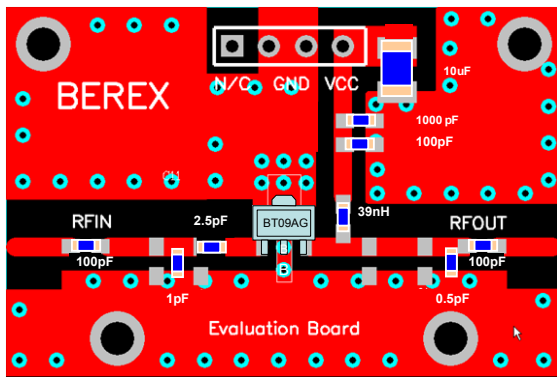

Note:

1. PCB: 31mil thick FR4.
2. Distance between the center of the series cap(C7) and the input pin of BT09AG _ **2.5mm.**
3. Distance between the center of the shunt cap(C6) and the input pin of BT09AG _ **3.5mm.**
4. Distance between the center of the shunt cap(C8) and the output pin of BT09AG _ **9.0mm.**

Typical Performance

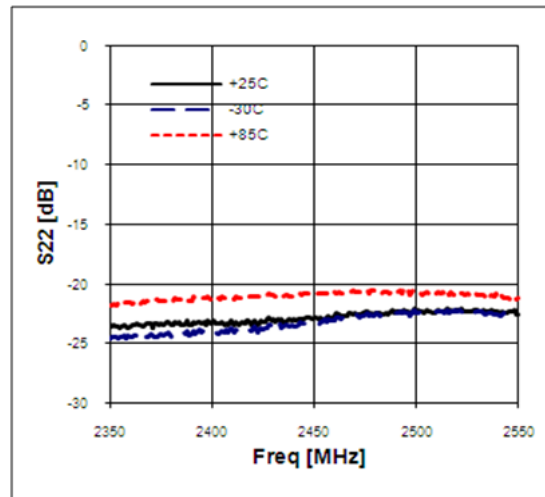
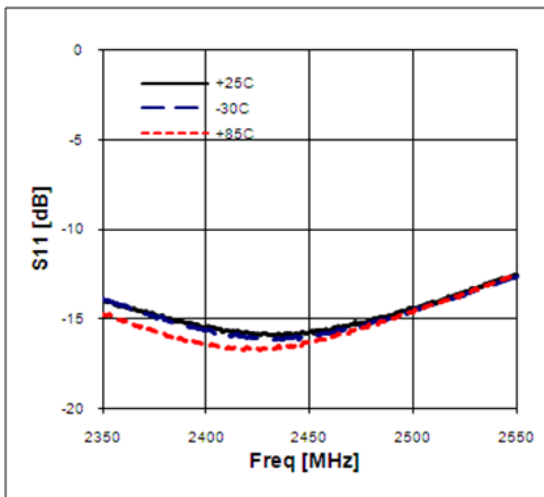

BT09AG

5-4000 MHz Wideband Medium Power Amplifier

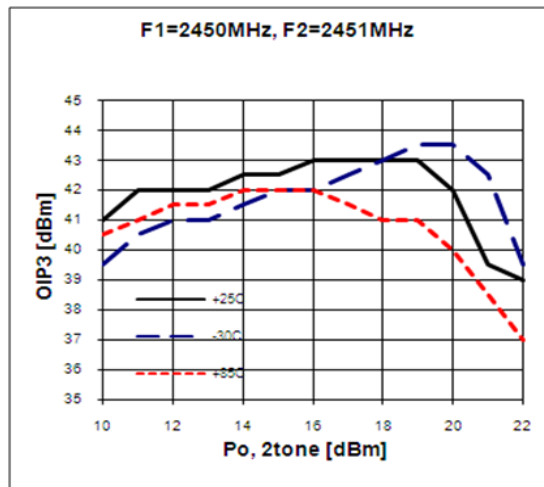
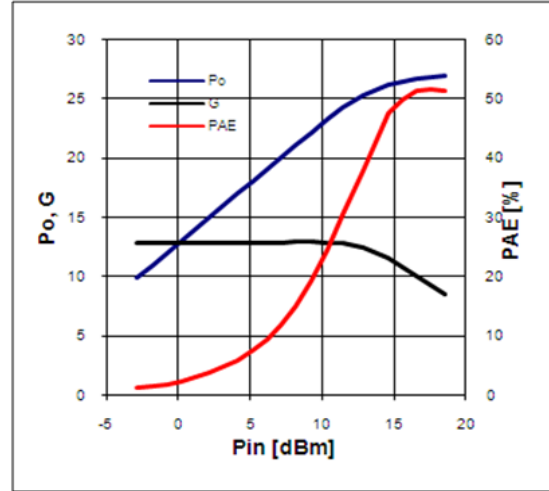
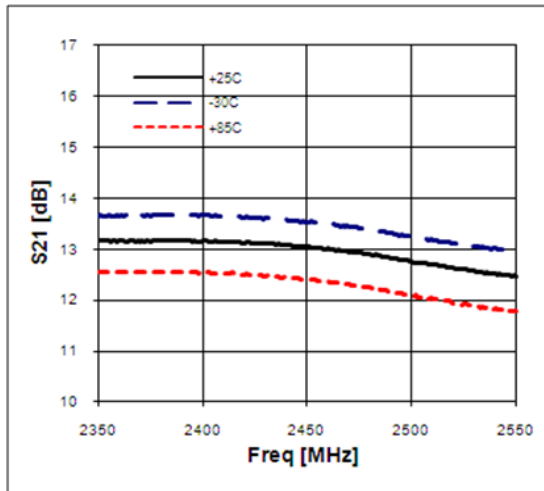

BT09AG

5-4000 MHz Wideband Medium Power Amplifier



Application Circuit: 3500MHz

Schematic Diagram		BOM	Tolerance
	C1	100pF	±5%
	C2	1000pF	±5%
	C3	10uF	±20%
	C4	22pF	±5%
	C5	22pF	±5%
	C6	0.5pF	±5%
	C7	0.5pF	±5%
	C8	0.5pF	±5%
	L1	33nH	±5%

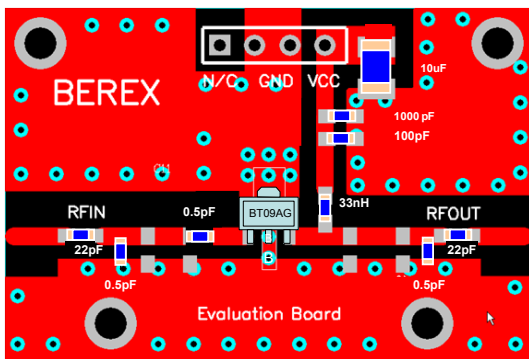

Note:

1. PCB: 31mil thick FR4.
2. Distance between the center of the series cap(C7) and the input pin of BT09AG _ 2.5mm.
3. Distance between the center of the shunt cap(C6) and the input pin of BT09AG _ 9.2mm.
4. Distance between the center of the shunt cap(C8) and the output pin of BT09AG _ 8.0mm.

Typical Performance

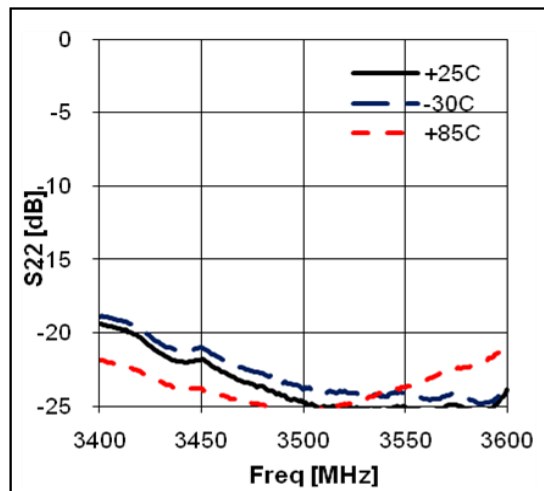
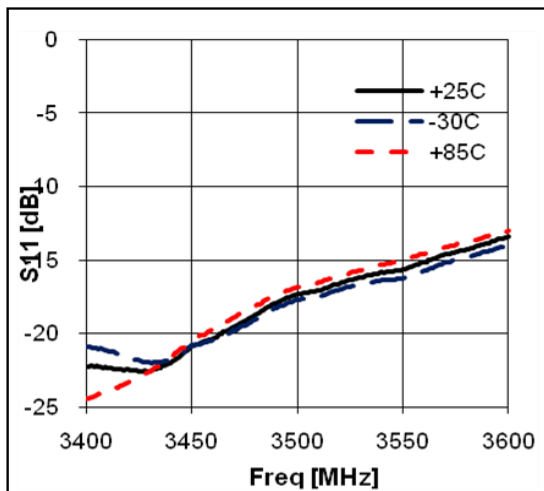

BT09AG

5-4000 MHz Wideband Medium Power Amplifier



Typical Performance

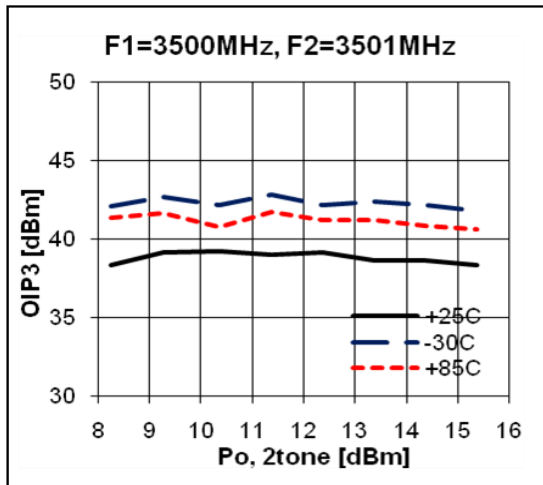
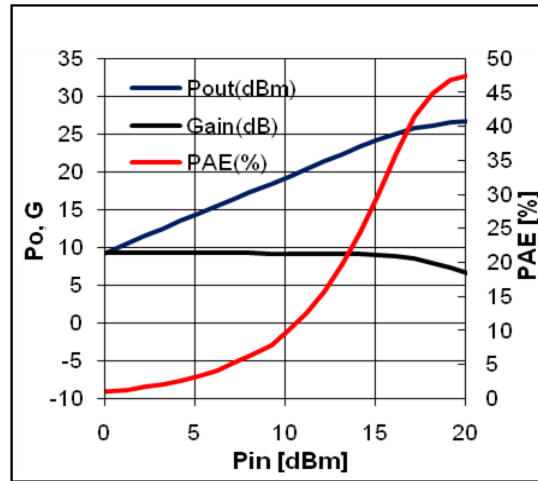
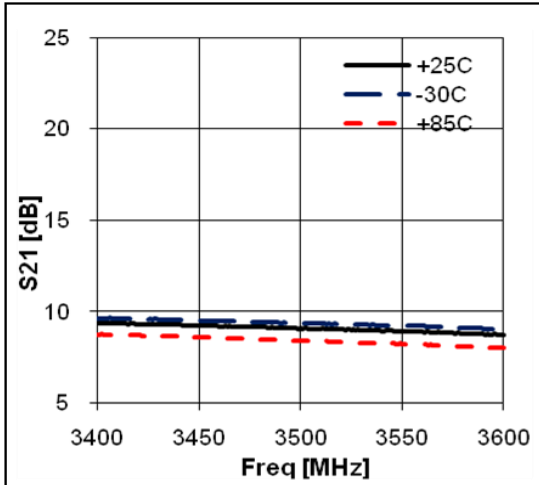

BT09AG

5-4000 MHz Wideband Medium Power Amplifier



Package Outline Dimension

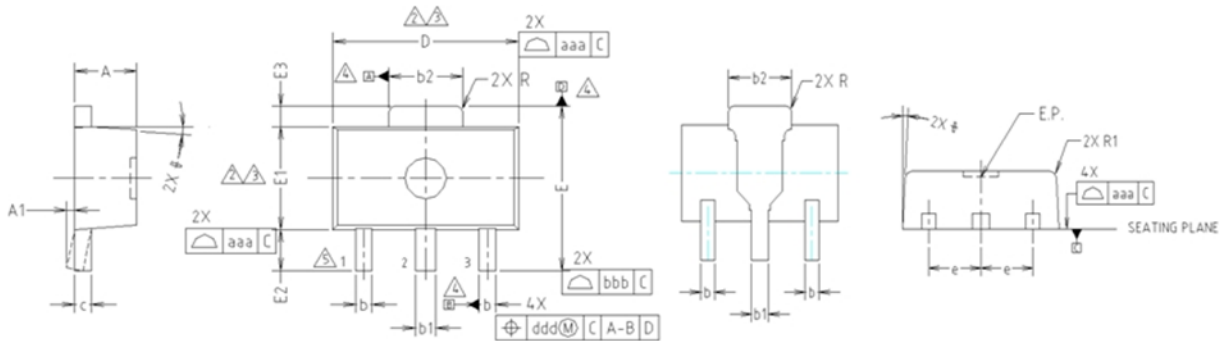

- NOTE:**
1. DIMENSIONS IN MILLIMETERS.
- ⚠ DIMENSION D DOES NOT INCLUDE MOLD FLASH, PROTRUSIONS OR GATE BURRS. MOLD FLASH, PROTRUSIONS OR GATE BURRS SHALL NOT EXCEED 0.5mm PER END. DIMENSION E1 DOES NOT INCLUDE INTERLEAD FLASH OR PROTRUSION. INTERLEAD FLASH OR PROTRUSION SHALL NOT EXCEED 0.5mm PER SIDE.
 - ⚠ DIMENSIONS D AND E1 ARE DETERMINED AT THE OUTMOST EXTREMES OF THE PLASTIC BODY EXCLUSIVE OF MOLD FLASH, TIE BAR BURRS, GATE BURRS AND INTERLEAD FLASH, BUT INCLUDING ANY MISMATCH BETWEEN THE TOP AND BOTTOM OF THE PLASTIC BODY.
 - ⚠ DATUMS A, B AND D TO BE DETERMINED 0.18mm FROM THE LEAD TIP.
 - ⚠ TERMINAL NUMBERS ARE SHOWN FOR REFERENCE ONLY.

SYMBOL	MILLIMETERS			NOTE
	MINIMUM	NOMINAL	MAXIMUM	
A	1.40	1.50	1.60	
A1	0.00	—	0.10	
b	0.38	0.42	0.48	
b1	0.48	0.52	0.58	
b2	1.79	1.82	1.87	
c	0.40	0.42	0.46	
D	4.40	4.50	4.70	2,3
E	3.70	4.00	4.30	
E1	2.40	2.50	2.70	2,3
E2	0.80	1.00	1.20	
E3	0.40	0.50	0.60	
e	1.50 TYP.			
φ	4° TYP.			
R	0.15 TYP.			
R1	—	—	0.20	
SYMBOL	TOLERANCES OF FORM AND POSITION		NOTE	
aaa	0.15			
bbb	0.20			
ccc	0.10			
ddd	0.10			

Suggested PCB Land Pattern and PAD Layout

PCB Land Pattern

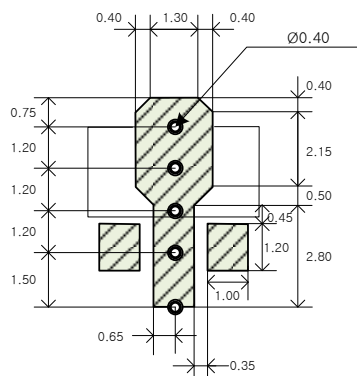

Note : All dimension are in millimeters

PCB lay out _ on BeRex website

PCB Mounting

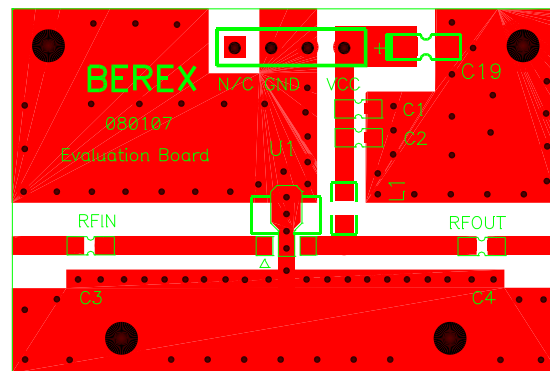

BT09AG

5-4000 MHz Wideband Medium Power Amplifier



Package Marking

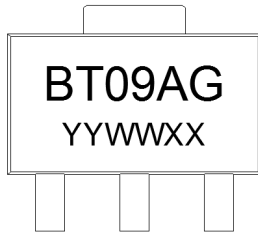

Pin 1

YY = Year, WW = Working Week,
XX = Wafer No.

Tape & Reel

SOT89

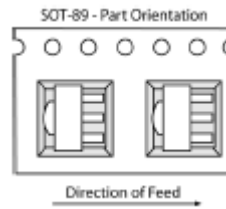

Packaging information:

Tape Width (mm): 12
Reel Size (inches): 7
Device Cavity Pitch (mm): 8
Devices Per Reel: 1000

Lead plating finish

100% Tin Matte finish

(All BeRex products undergoes a 1 hour, 150 degree C, Anneal bake to eliminate thin whisker growth concerns.)

MSL / ESD Rating

ESD Rating:	Class 1B
Value:	Passes <1000V
Test:	Human Body Model (HBM)
Standard:	JEDEC Standard JESD22-A114B
MSL Rating:	Level 1 at +265°C convection reflow
Standard:	JEDEC Standard J-STD-020

NATO CAGE code:

2	N	9	6	F
---	---	---	---	---