

BGS3

30-4000 MHz SILICON GERMANIUM Gain Block

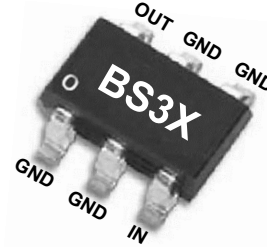

Part Marking (X: Wafer number)



Pin Description	
RF IN	3
RF OUT	6
GND	1,2,4,5

Device Features

- Single Fixed 3V supply
- No Dropping Resistor Required
- No matching circuit needed
- Lead-free/Green/RoHS compliant SOT-363 package
- Application: Driver Amplifier, Cellular, PCS, GSM, UMTS, WCDMA, Wireless Data

Product Description

BeRex's BGS3 is a high SiGe HBT MMIC amplifier, internally matched to 50 Ohms without the need for external components. Designed to run directly from a 3V supply. The BGS3 is designed for high linearity 3V gain block applications. It is packaged in a RoHS-compliant with SOT-363 surface mount package.

Applications

- Driver Amplifier
- Cellular, PCS, GSM, UMTS, WCDMA

Applications Circuit

Application Circuit Values Example			
Freq.	50~900MHz	900MHz~3GHz	3GHz~4GHz
C1/C2	2nF	100pF	10pF
L1 (1608 Chip Ind.)	820nH	56nH	12nH

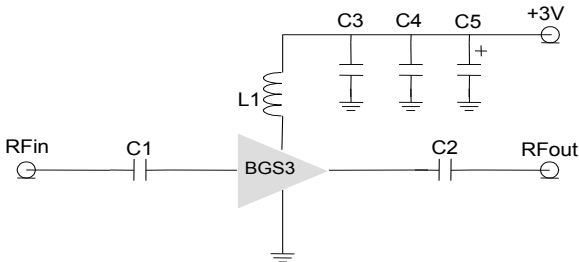

- *C1, C2, C3 = 100 pF ± 5%; C4 = 1000 pF ± 5%; C5 = 10uF; **L1 = 56nH
- **less than 56nH improves RF performance at over 0.9GHz.
- *820nH or higher value L1 improves RF performance at under
- *Optimum value of L1 may vary with board design.
- *C1,C2=2000pF, L1=820nH for 50MHz application.
- *C1,C2=10pF, L1=12nH for 3.5GHz application.

Typical Performance¹

Parameter	Frequency					Unit
	70	900	1900	2450	3500	
Gain	28	25.4	21.6	20	18	dB
S11	-17	-17	-17	-20	-14.5	dB
S22	-14	-14	-14	-16	-18.9	dB
OIP3 ²	30.5	30.5	30.5	28.5	27.2	dBm
P1dB	16.7	17.4	16.9	16	14.5	dBm
Noise Figure	1.8	1.7	1.8	1.9	2	dB

¹ Device performance _ measured on a BeRex evaluation board at 25°C, 50 Ω system.

² OIP3 _ measured with two tones at an output of 0 dBm per tone separated by 1 MHz.

	Min.	Typical	Max.	Unit
Bandwidth	50		4000	MHz
I _c @ (V _c = 3V)	48	55	62	mA
V _c		3.0		V
dG/dT		-0.006		dB/°C
R _{TH}		130		°C/W

Absolute Maximum Ratings

Parameter	Rating	Unit
Operating Case Temperature	-40 to +85	°C
Storage Temperature	-55 to +155	°C
Junction Temperature	150	°C
Operating Voltage	+3.3	V
Supply Current	110	mA
Input RF Power	12	dBm

Operation of this device above any of these parameters may result in permanent damage.

BGS3

30-4000 MHz SILICON GERMANIUM Gain Block



Preliminary Datasheet

V-I Characteristics

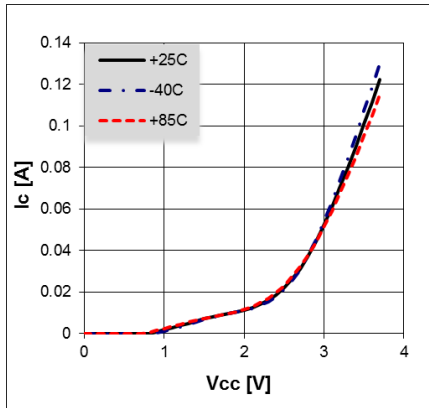

BeRex SOT-363 Evaluation

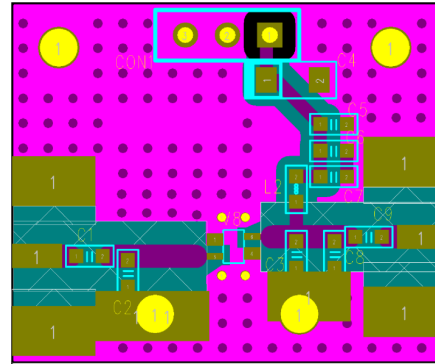

*Dielectric constant_ 4.2 *31mil thick FR4 PCB

Suggested PCB Land Pattern and PAD Layout

PCB Land Pattern

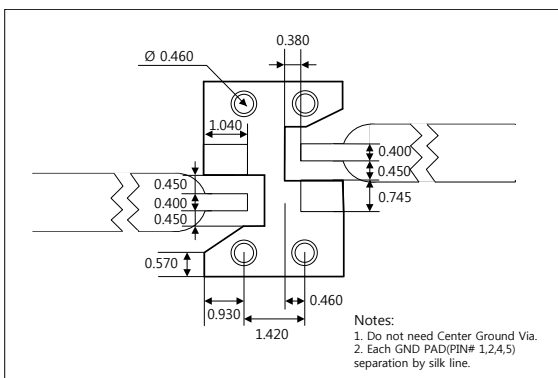

Note : All dimension _ millimeters

PCB lay out _ on BeRex website

PCB Mounting

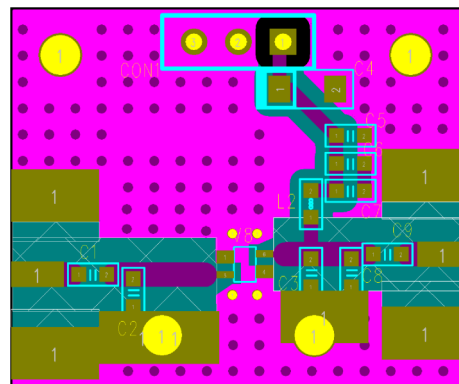



Typical Device Data

S-parameters (Vc=3V, Ic=52mA, T=25°C, Bias Tee Data)

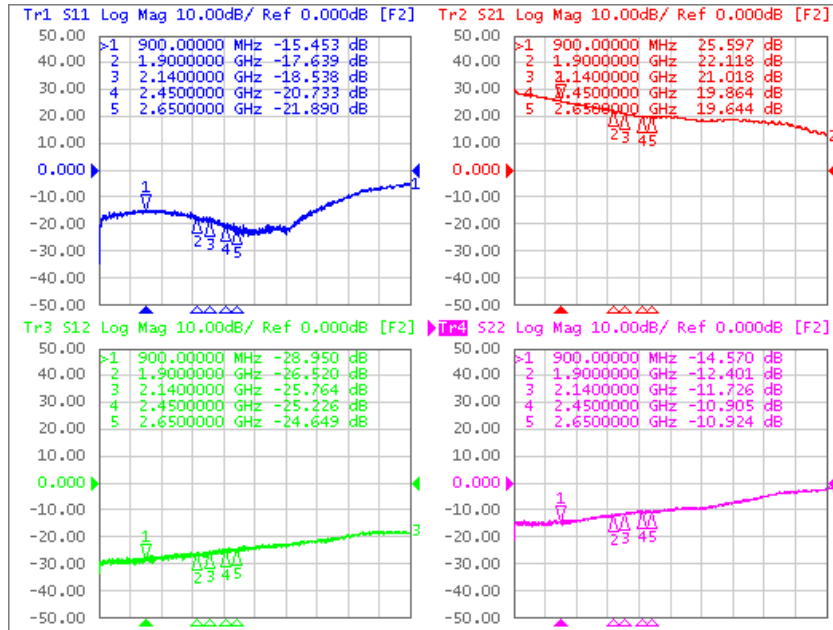

S-Parameter

(Vdevice = 3.0V, Icc = 52mA, T = 25 °C, calibrated to device leads, Bias Tee Data)

Freq [MHz]	S11 Mag	S11 Ang	S21 Mag	S21 Ang	S12 Mag	S12 Ang	S22 Mag	S22 Ang
70.00	0.125	-168.1	26.57	169.6	0.033	11.51	0.172	-163.6
900.00	0.17	73.68	19.0	130.4	0.035	28.7	0.181	135.7
1000.00	0.17	68.3	18.4	126.8	0.38	227	0.19	135.5
1500.00	0.156	44.0	14.69	112.6	0.042	31.7	0.218	121.2
2000.00	0.125	35.0	12.1	97.7	0.047	40.2	0.248	109.8
2500.00	0.085	29.1	9.61	93.1	0.056	48.8	0.282	94.1
3500.00	0.075	76.9	8.51	74.8	0.065	56.2	0.328	63.8
4000.00	0.141	93.7	8.18	69.0	0.080	56.9	0.393	50.4

Typical Performance (Vd = 3.0V, Ic = 52mA, T = 25°C)

Freq	MHz	30	50	70	900	1900	2140	2450	2650	3500
S21	dB	28.8	28.6	28	25.4	21.6	20.8	20	19.5	18
S11	dB	-13	-16	-17	-17	-17	-18	-20	-22	-14.5
S22	dB	-15	-15	-14	-14	-14	-14	-16	-17	-18.9
P1	dBm	16	16.2	16.7	17.4	16.9	16	16	15.9	14.5
OIP3	dBm	30	31	30.5	30.5	30.5	29	28.5	28.5	27.2
NF	dB	1.9	1.6	1.8	1.7	1.8	1.9	1.9	2	2

BGS3



30-4000 MHz SILICON GERMANIUM Gain Block

Typical Performance (Vd = 2.7V, Ic = 34mA, T = 25°C)

Freq	MHz	30	50	70	900	1900	2140	2450	2650
S21	dB	27.9	27.3	27.1	24.7	21.1	20.5	19.6	19.1
S11	dB	-12.1	-16	-19.4	-20.7	-17.8	-18.3	-18.7	-17.8
S22	dB	-24	-36	-32.4	-19	-14.7	-14.8	-15.9	-16.9
P1	dBm	14.2	14.2	14.7	14.8	15.2	14.5	14.8	15.2
OIP3	dBm	26.6	28.7	27.9	26.4	26.7	26.3	26.5	27.1
NF	dB	1.82	1.52	1.64	1.6	1.74	1.77	1.83	1.88

Typical Performance (Vd = 2.8V, Ic = 40mA, T = 25°C)

Freq	MHz	30	50	70	900	1900	2140	2450	2650
S21	dB	28.6	28	27.7	25.1	21.4	20.7	19.9	19.3
S11	dB	-13.1	-17.1	-20.2	-20.4	-17.7	-18.4	-19.5	-19
S22	dB	-33	-23.1	-21.4	-17.5	-15.1	-15.4	-16.6	-18
P1	dBm	14.9	14.8	15.3	15.6	15.7	15	15.1	15.5
OIP3	dBm	27.7	29.5	28.8	28	28.2	27.7	27.8	28.1
NF	dB	1.85	1.54	1.65	1.61	1.75	1.8	1.85	1.9

Typical Performance (Vd = 2.9V, Ic = 47mA, T = 25°C)

Freq	MHz	30	50	70	900	1900	2140	2450	2650
S21	dB	29.1	28.5	28.2	25.4	21.6	20.9	20	19.5
S11	dB	-13.4	-16.6	-18.3	-18.8	-17.1	-17.9	-19.7	-19.6
S22	dB	-22.3	-18	-17.6	-15.9	-15.4	-15.7	-17.1	-18.7
P1	dBm	15.5	15.5	16.1	17.2	16.7	15.9	15.5	15.9
OIP3	dBm	29.1	30.6	30.4	29.5	29.5	29	28.6	29.0
NF	dB	1.9	1.57	1.67	1.64	1.77	1.81	1.87	1.92

BGS3



30-4000 MHz SILICON GERMANIUM Gain Block

Typical Performance (Vd = 3.1V, Ic = 65mA, T = 25°C)

Freq	MHz	30	50	70	900	1900	2140	2450	2650
S21	dB	29.8	29.1	28.8	25.8	21.9	21.1	20.2	19.7
S11	dB	-13	-14.6	-15.2	-16.4	-16.3	-17.2	-19.1	-19.7
S22	dB	-15.9	-13.6	-13.2	-13.9	-15.4	-16	-17.7	-19.6
P1	dBm	16.7	17.1	17.7	17.4	16.8	16.1	16.2	16.4
OIP3	dBm	30.3	31.6	31.3	30.7	29.1	28.9	28.3	28.3
NF	dB	1.98	1.62	1.7	1.68	1.81	1.86	1.93	1.98

Typical Performance (Vd = 3.2V, Ic = 75mA, T = 25°C)

Freq	MHz	30	50	70	900	1900	2140	2450	2650
S21	dB	29.9	29.2	28.9	25.9	21.9	21.2	20.3	19.7
S11	dB	-12.8	-14	-14.4	-15.8	-16	-17.1	-19.1	-19.6
S22	dB	-14.6	-12.7	-12.3	-13.5	-15.4	-16	-17.8	-19.8
P1	dBm	17.3	17.8	18.4	16.9	16.6	16	16.2	16.5
OIP3	dBm	29.6	30.5	30.3	29.5	28	27.6	26.7	26.6
NF	dB	2.04	1.65	1.73	1.72	1.83	1.9	1.96	2

Typical Performance (Vd = 3.3V, Ic = 86mA, T = 25°C)

Freq	MHz	30	50	70	900	1900	2140	2450	2650
S21	dB	30	29.3	29	25.9	21.9	21.2	20.3	19.7
S11	dB	-12.6	-13.7	-14	-15.5	-16.1	-17	-19	-19.4
S22	dB	-13.8	-12.1	-11.7	-13.1	-15.5	-16.2	-18	-20.1
P1	dBm	17.9	18.2	18.6	16.6	16.5	15.8	16.2	16.4
OIP3	dBm	28.6	29.8	29.6	29	27.4	26.7	26	25.6
NF	dB	2.11	1.7	1.76	1.74	1.89	1.93	1.99	2



Device Performance

Pin-Pout-Gain

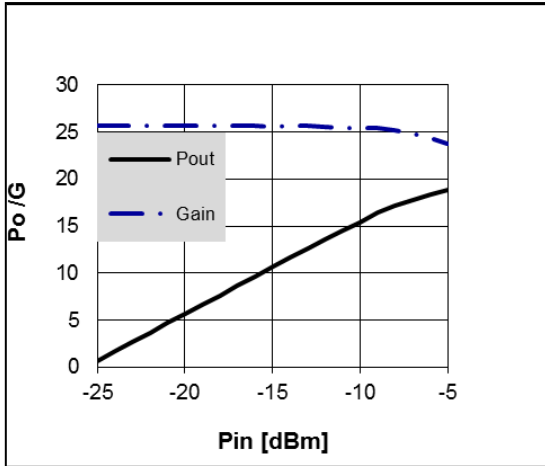

900MHz, 3V/52mA

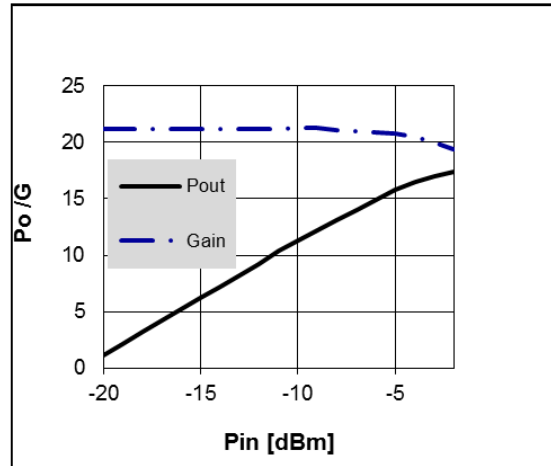

1900 MHz, 3V/52mA

OIP3

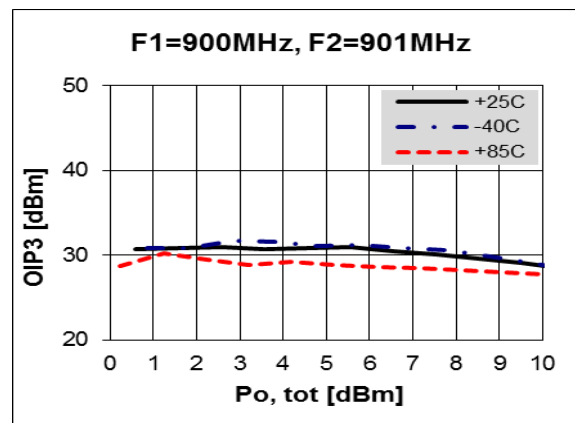
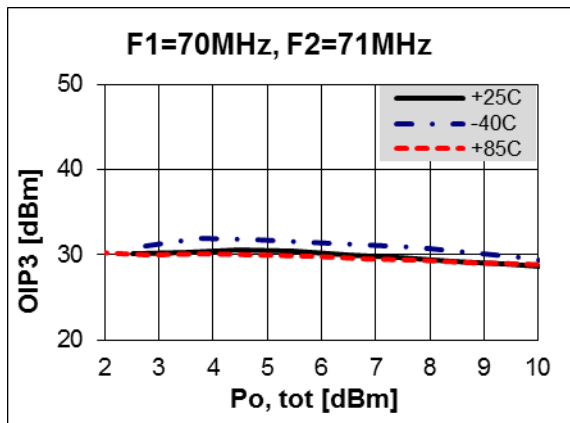

BGS3

30-4000 MHz SILICON GERMANIUM Gain Block



Preliminary Datasheet

OIP3

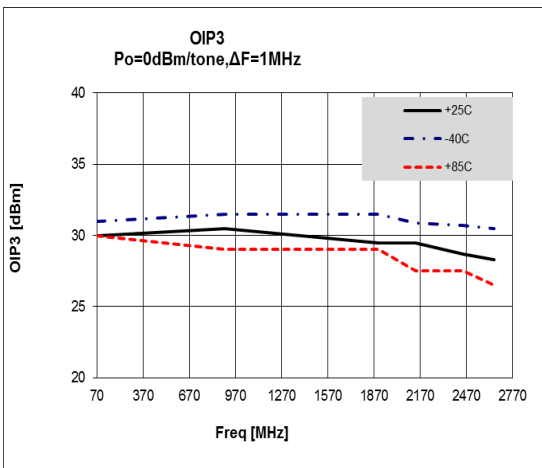
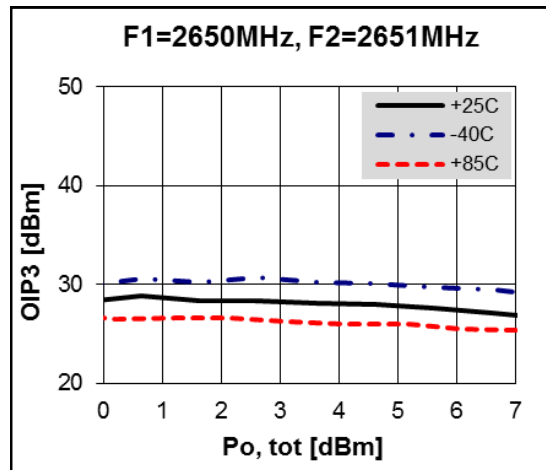
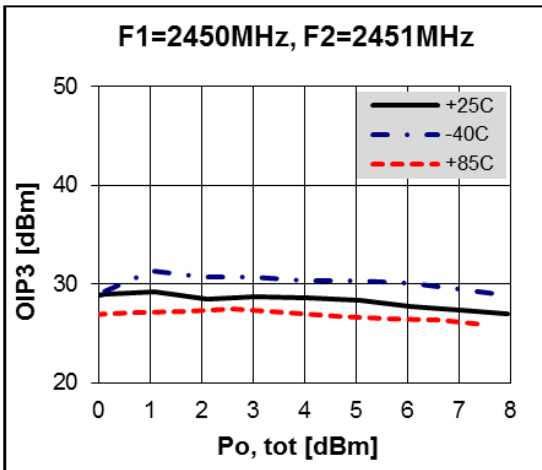
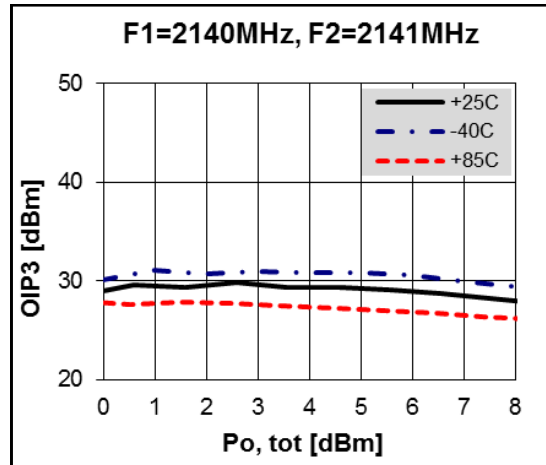
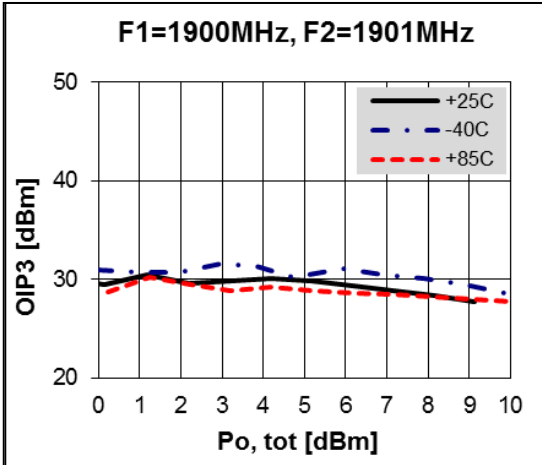

BGS3

30-4000 MHz SILICON GERMANIUM Gain Block



Gain Flatness

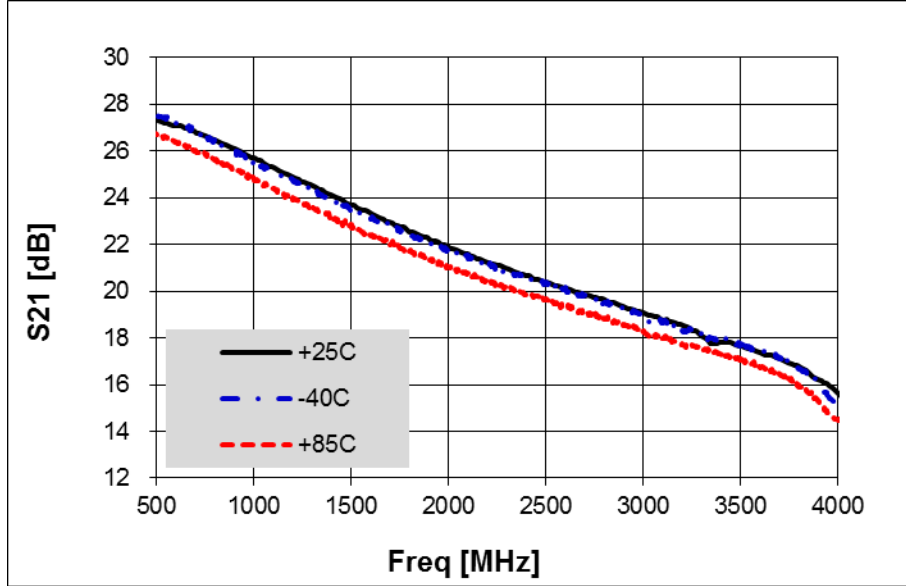

Package Outline Dimension (Unit. mm)

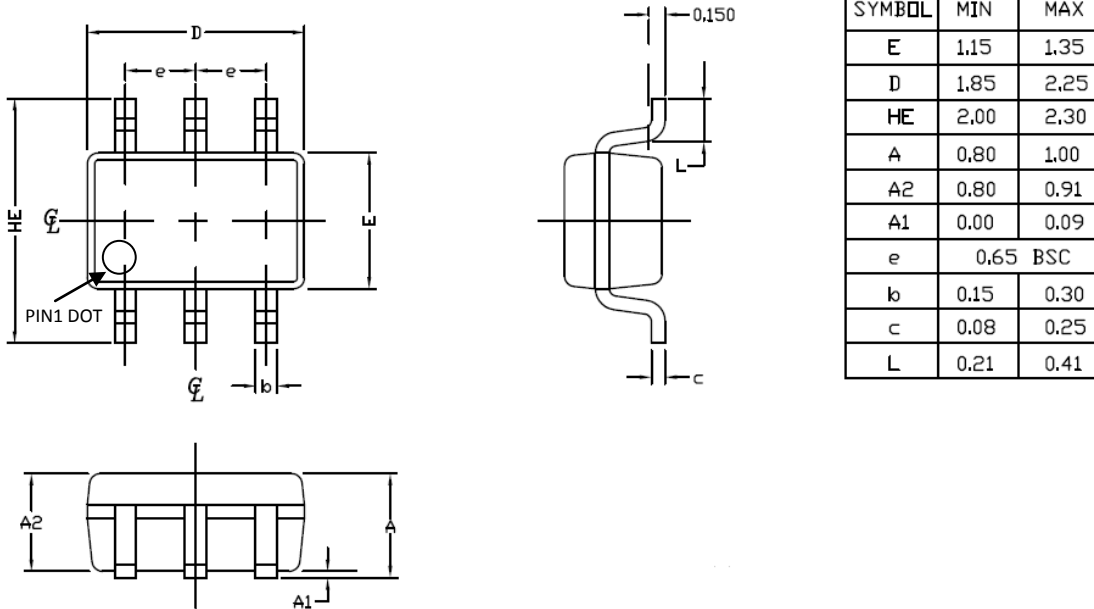

BGS3

30-4000 MHz SILICON GERMANIUM Gain Block



Package Marking

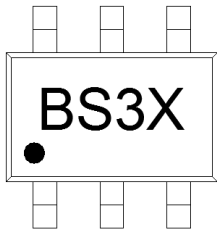

Pin 1

X = Wafer No.

Tape & Reel

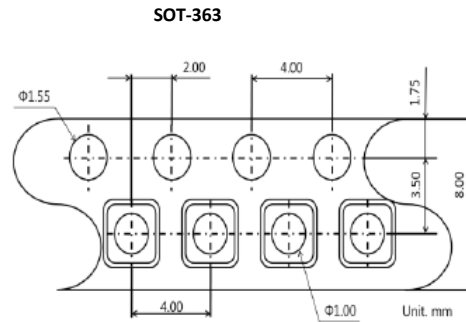

Packaging information:

- Tape Width (mm): 8
- Reel Size (inches): 7
- Device Cavity Pitch (mm): 4
- Devices Per Reel: 3000

Lead plating finish

100% Tin Matte finish

(All BeRex products undergoes a 1 hour, 150 degree C, Anneal bake to eliminate thin whisker growth concerns.)

MSL / ESD Rating

ESD Rating:	Class 1C
Value:	Passes <2000V
Test:	Human Body Model (HBM)
Standard:	JEDEC Standard JESD22-A114B
MSL Rating:	Level 1 at +265°C convection reflow
Standard:	JEDEC Standard J-STD-020

NATO CAGE code:

2	N	9	6	F
---	---	---	---	---

Preliminary Datasheet