

BL082

5-4000 MHz Wideband Low Noise Amplifier



Part Marking (X:Wafer number)

Device Features

- This can be operated at Vd of 3.3V and 5V
- N.F = 0.88 dB @ 900MHz at Demo board
- 31.6 dBm Output IP3 at 5dBm/ tone at 2350MHz
- 20.9 dB Gain at 900MHz
- 19.5 dBm P1dB at 2140 MHz
- Lead-free/Green/RoHS Compliant SOT363 SMT Package

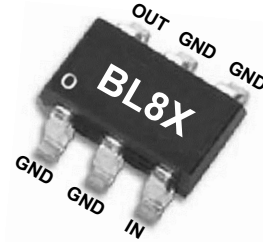

Product Description

BeRex's BL082 is a high performance LNA, based on GaAs material with E-pHEMT process and packaged in a RoHS-compliant with SOT-363 Surface mount package. It is designed for use where low noise and high linearity are required and features low noise and high OIP3 with low current at wideband frequency. It requires a few external matching components. All devices are 100% RF/DC tested and classified as HBM ESD Class 0.

Typical Performance¹

Parameter	Frequency						Unit
	Vd = 5.0V	900	1900	2140	2350	2650	
Gain	20.9	17.1	16.2	15.6	14.6	12.5	dB
S11	-26	-29	-20	-28	-26	-19.3	dB
S22	-27	-18	-17	-16	-13	-15.2	dB
OIP3 ²	28	30.3	30.6	31.6	31.4	29.9	dBm
P1dB	18.8	19.2	19.5	19.3	19	18.6	dBm
N.F	0.88	1	1.08	1.14	1.14	1.3	dB

Parameter	Frequency						Unit
	Vd = 3.3V	900	1900	2140	2350	2650	
Gain	20.7	17	16	15.3	14.5	12.4	dB
S11	-27	-30	-22	-30	-25	-20.6	dB
S22	-26	-20	-19	-19	-16.5	-24.5	dB
OIP3 ³	26.3	28.3	28.5	28.9	28.9	29.6	dBm
P1dB	15.6	15.9	16.2	16.3	16.2	15.5	dBm
N.F	0.85	0.97	1.04	1.09	1.09	1.2	dB

Applications

- Base station Infrastructure/RFID
- Commercial/Industrial/Military wireless system

Applications Circuit

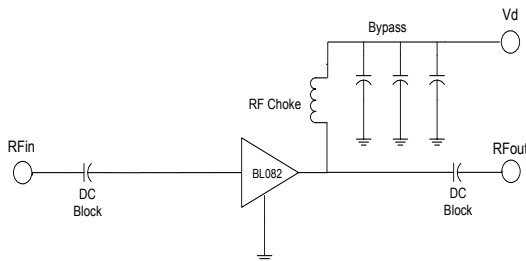

*External matching circuit : refer to the page 4 to 16

¹ Device performance _ measured on BeRex's evaluation board at 25°C, 50 Ω system.

² OIP3 _ measured on two tones with a output power 5 dBm/ tone , F2—F1 = 1 MHz.

³ OIP3 _ measured on two tones with a output power 3 dBm/ tone , F2—F1 = 1 MHz.

	Min.	Typical	Max.	Unit
Bandwidth	5		4000	MHz
I _d @ (Vd = 5.0V)	15	27	35	mA
I _d @ (Vd = 3.3V)	12	18	24	
dG/dT		-0.006		dB/°C
R _{TH}		95		°C/W

BL082

5-4000 MHz Wideband Low Noise Amplifier



Absolute Maximum Ratings

Parameter	Rating	Unit
Operating Case Temperature	-40 to +85	°C
Storage Temperature	-55 to +155	°C
Junction Temperature	+220	°C
Operating Voltage	+6.0	V
Supply Current	160	mA
Input RF Power	24	dBm

Operation of this device above any of these parameters may result in permanent damage.

V-I Characteristics

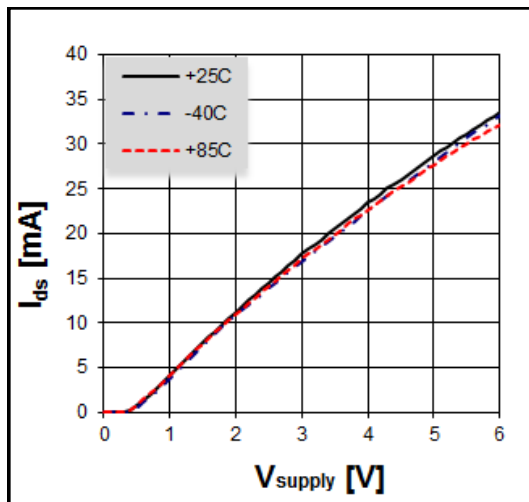

BeRex SOT363 Evaluation Board

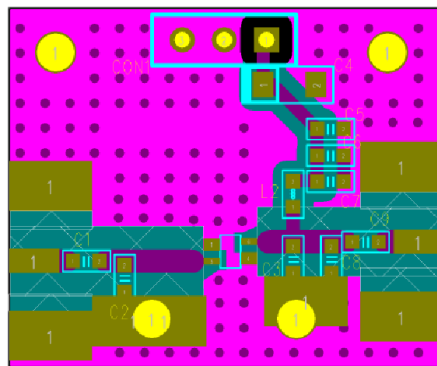

*Dielectric constant _ 4.2 *RF pattern width 52mil *31mil thick FR4 PCB

*Without vias under device degrade device performance.



Typical Device Data

S-parameters ($V_d=5.0V$, $I_d=27mA$, $T=25^\circ C$)

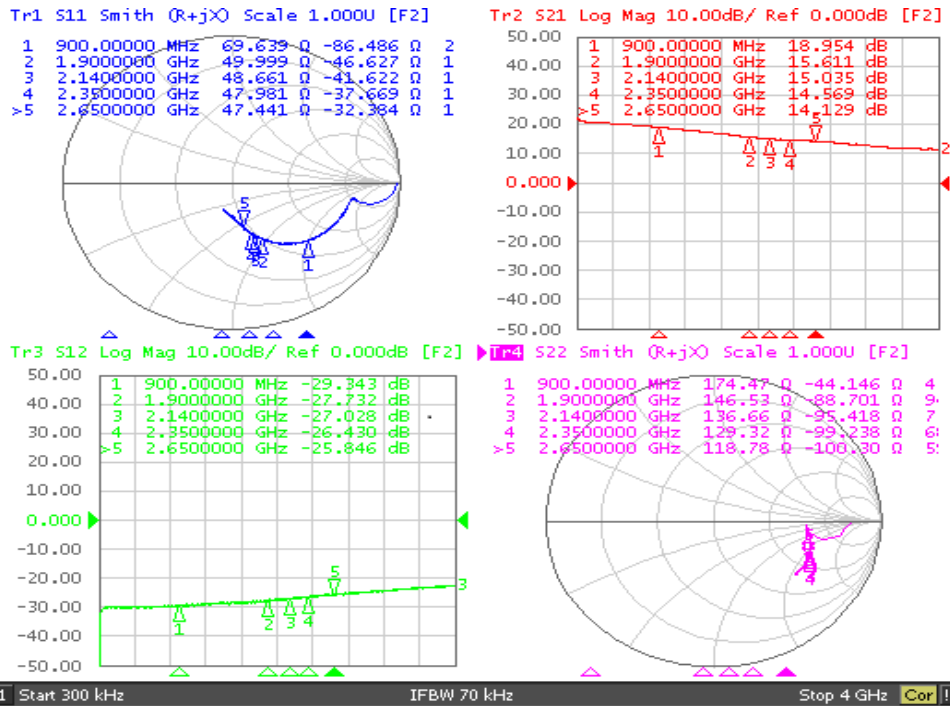

S-parameters ($V_d=3.3V$, $I_d=18mA$, $T=25^\circ C$)

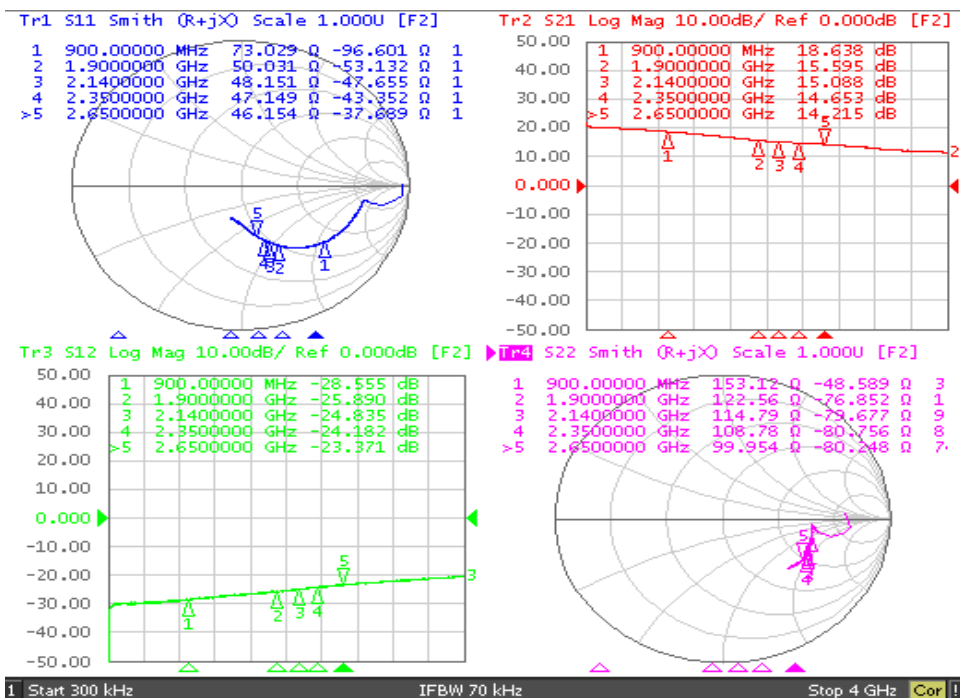

5-4000 MHz Wideband Low Noise Amplifier

S-Parameter

(Vd=5.0V, Id = 27mA, T = 25 °C, calibrated to device leads)

Freq [MHz]	S11 Mag	S11 Ang	S21 Mag	S21 Ang	S12 Mag	S12 Ang	S22 Mag	S22 Ang
40	-2.29	-9.57	21.16	173.05	-31.23	24.95	-4.34	-9.36
70	-2.68	-8.88	20.91	173.03	-30.11	16.14	-4.85	-6.90
250	-3.06	-14.48	20.59	165.75	-29.65	12.76	-5.18	-3.93
500	-3.48	-25.67	20.04	154.53	-29.99	14.93	-5.02	-4.99
1000	-4.71	-44.66	18.70	134.90	-29.41	27.50	-4.70	-9.27
1500	-6.24	-57.52	17.06	119.30	-28.47	37.06	-4.49	-14.47
2000	-7.73	-67.16	15.37	108.77	-27.42	45.98	-4.28	-19.09
2500	-9.35	-74.58	14.48	100.78	-26.01	53.57	-4.15	-23.65
3000	-11.37	-82.86	13.26	88.64	-24.72	57.28	-4.17	-27.99
3500	-13.11	-92.60	11.93	82.51	-23.60	61.17	-4.19	-32.00
4000	-14.38	-106.14	11.17	75.97	-22.65	65.89	-4.18	-36.72

(Vd=3.3V, Id = 18mA, T = 25 °C, calibrated to device leads)

Freq [MHz]	S11 Mag	S11 Ang	S21 Mag	S21 Ang	S12 Mag	S12 Ang	S22 Mag	S22 Ang
40	-2.15	-9.04	20.49	173.81	-31.08	29.96	-4.65	-9.19
70	-2.50	-8.01	20.28	173.95	-30.30	17.90	-5.13	-6.78
250	-2.81	-13.25	20.03	166.99	-29.76	14.00	-5.41	-4.91
500	-3.17	-23.56	19.58	156.45	-29.61	19.15	-5.34	-7.16
1000	-4.19	-41.48	18.43	137.29	-28.16	34.34	-5.22	-12.77
1500	-5.48	-54.34	16.94	121.73	-27.05	43.05	-5.08	-18.34
2000	-6.84	-64.40	15.37	110.94	-25.54	50.93	-5.07	-23.51
2500	-8.20	-72.33	14.54	102.36	-23.83	53.63	-5.04	-28.30
3000	-9.96	-81.09	13.36	90.17	-22.60	55.62	-5.22	-32.49
3500	-11.49	-91.30	12.07	83.52	-21.37	58.79	-5.38	-36.88
4000	-12.73	-104.77	11.33	76.62	-20.49	59.04	-5.62	-41.44

BL082

5-4000 MHz Wideband Low Noise Amplifier



Application Circuit: 900 MHz

Schematic Diagram		BOM	Tolerance	
		C1	10uF	± 20%
		C2	1nF	± 5%
		C3	100pF	±5%
		C4	100pF	±5%
		C5	100pF	±5%
		C6	0.5pF	± 5%
		L1	100nH	±5%
		L2	10nH	±5%
		L3	10nH	±5%

Typical Performance

$V_d = 5V, I_d = 27mA$

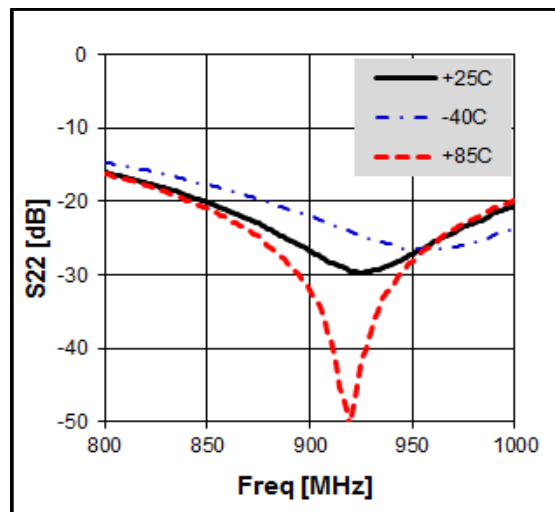
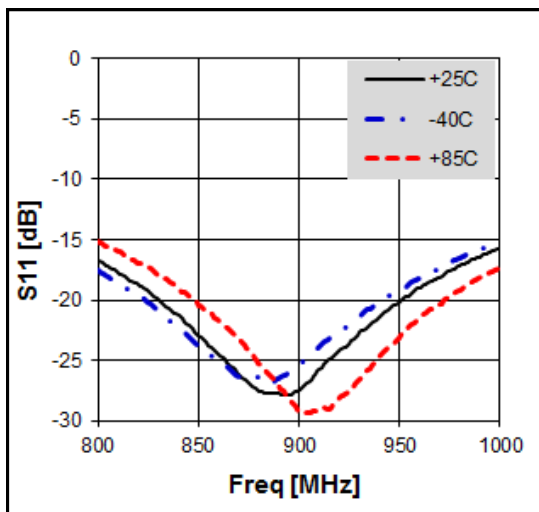

BL082



5-4000 MHz Wideband Low Noise Amplifier

$V_d = 5V, I_d = 27mA$

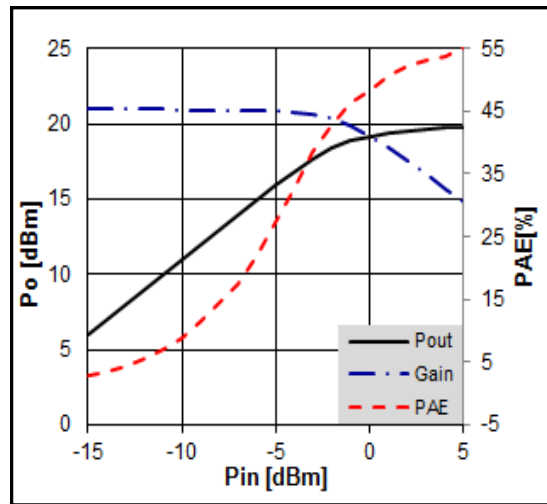
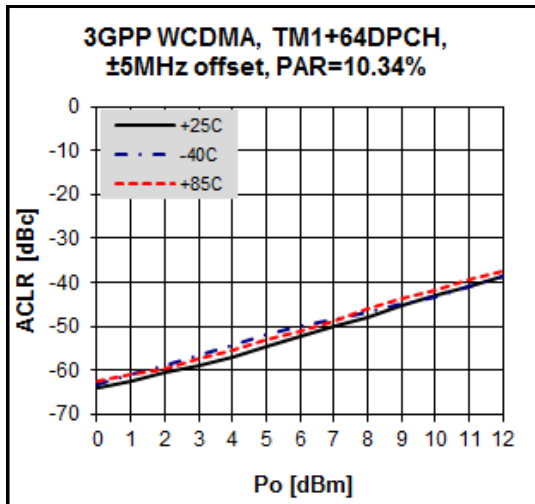
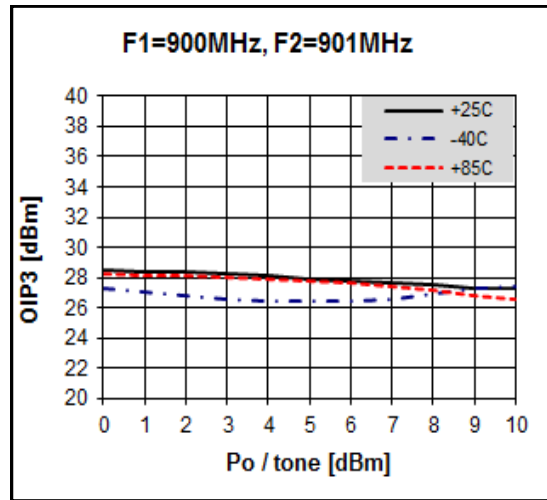
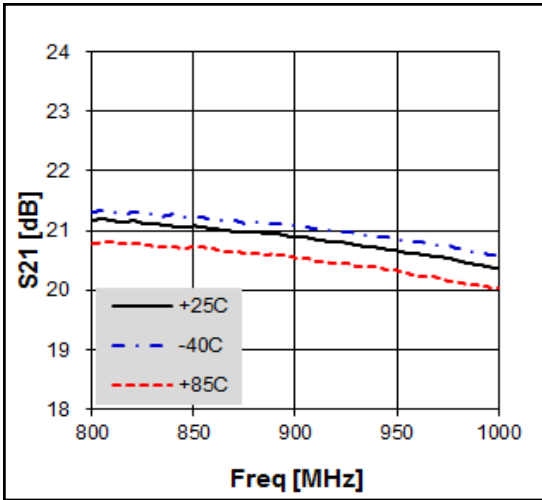

Noise Figure Temperature Performance

($V_{ds} = 5.0V, I_{ds} = 27.0mA$)

Preliminary Datasheet

BL082

5-4000 MHz Wideband Low Noise Amplifier



Application Circuit: 900 MHz

Schematic Diagram		BOM	Tolerance	
		C1	10uF	± 20%
		C2	1nF	± 5%
		C3	100pF	±5%
		C4	100pF	±5%
		C5	100pF	±5%
		C6	0.5pF	± 5%
		L1	100nH	±5%
		L2	10nH	±5%
		L3	10nH	±5%

Typical Performance

$V_d = 3.3V, I_d = 18mA$

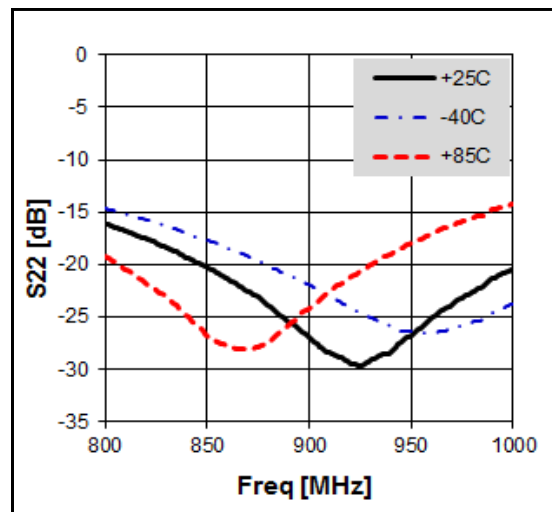
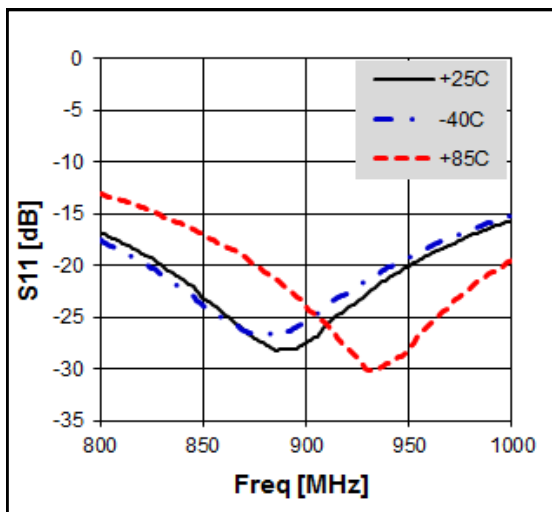

BL082



5-4000 MHz Wideband Low Noise Amplifier

$V_d = 3.3V, I_d = 18mA$

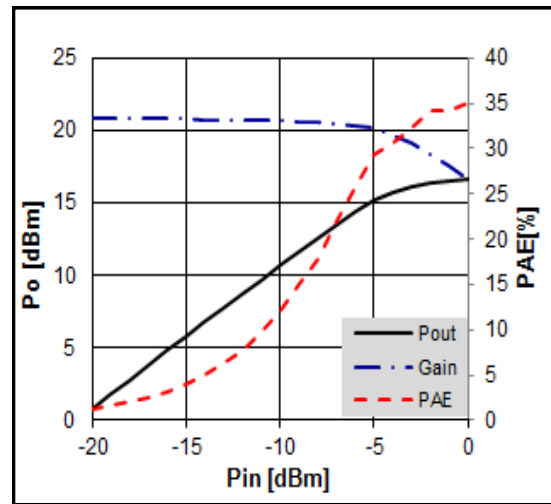
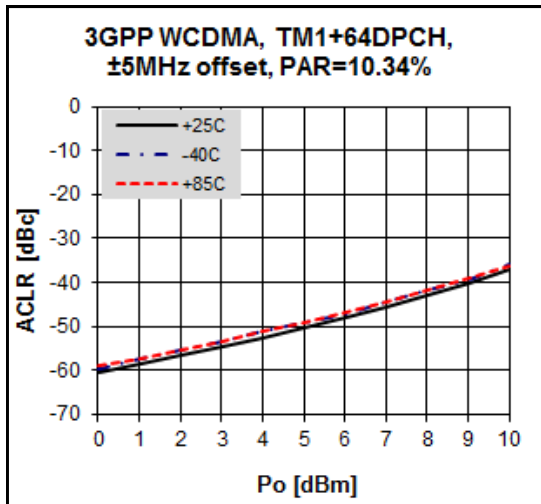
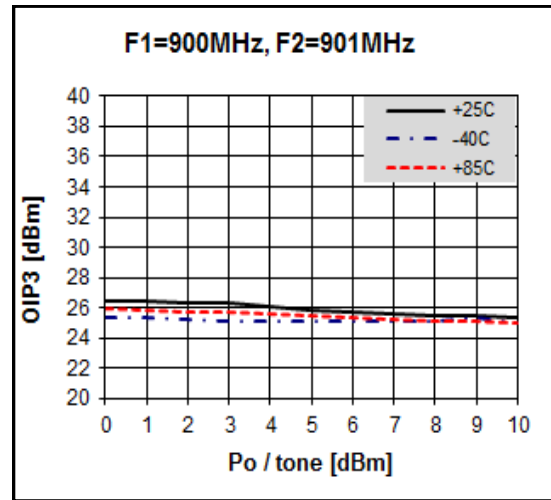
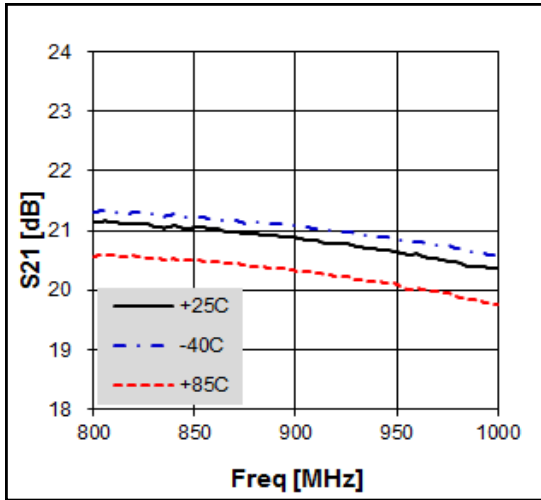

Noise Figure Temperature Performance

(V_{ds} = 3.3V, I_{ds} = 18.0mA)

Preliminary Datasheet

BL082

5-4000 MHz Wideband Low Noise Amplifier



Application Circuit: 1900 MHz

Schematic Diagram		BOM	Tolerance	
		C1	10uF	± 20%
		C2	1nF	± 5%
		C3	100pF	±5%
		C4	100pF	±5%
		C5	100pF	±5%
		C6	0.75pF	± 5%
		L1	27nH	±5%
		L2	3.3nH	±5%
		L3	4.7nH	±5%

Typical Performance

$V_d = 5V, I_d = 27mA$

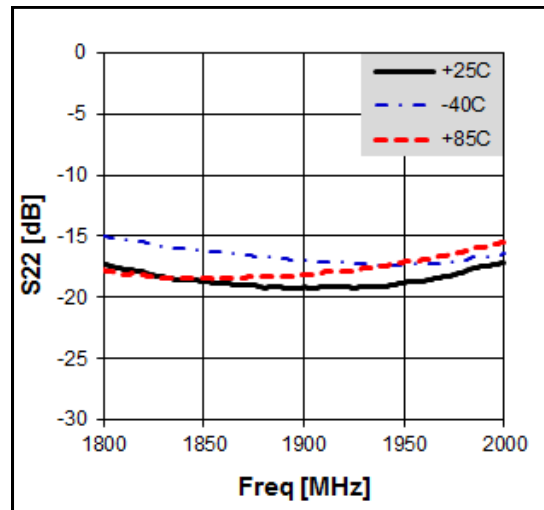
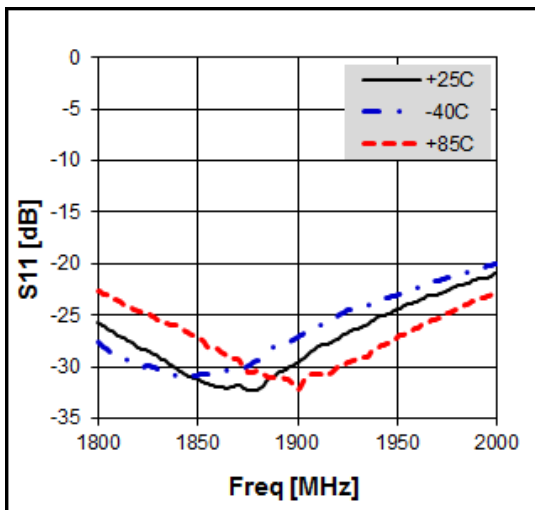

BL082



5-4000 MHz Wideband Low Noise Amplifier

$V_d = 5V, I_d = 27mA$

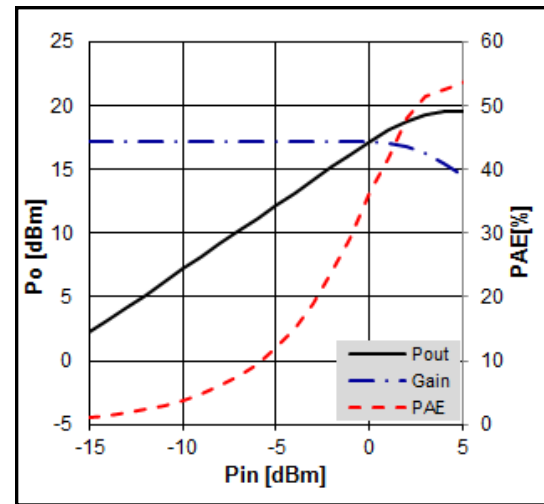
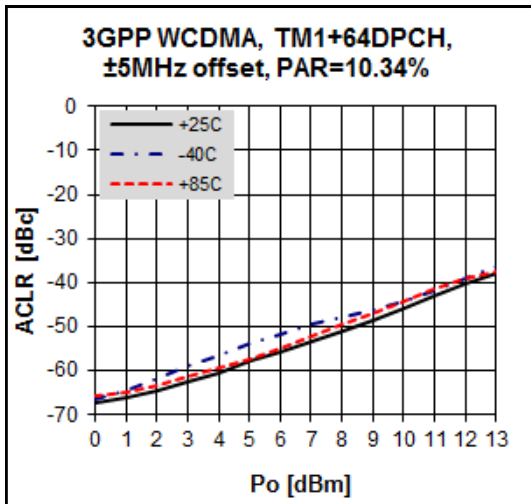
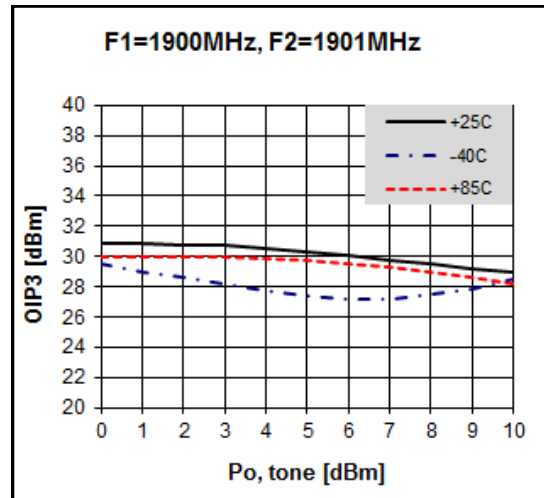
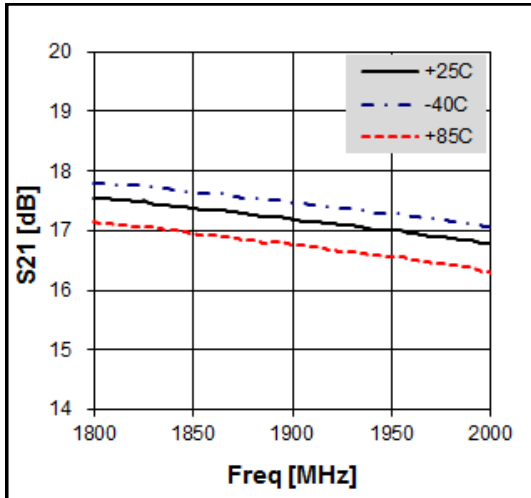

Noise Figure Temperature Performance

(V_{ds} = 5.0V, I_{ds} = 27.0mA)

Preliminary Datasheet

BL082

5-4000 MHz Wideband Low Noise Amplifier



Application Circuit: 1900 MHz

Schematic Diagram		BOM	Tolerance	
		C1	10uF	± 20%
		C2	1nF	± 5%
		C3	100pF	±5%
		C4	100pF	±5%
		C5	100pF	±5%
		C6	0.75pF	± 5%
		L1	27nH	±5%
		L2	3.3nH	±5%
		L3	4.7nH	±5%

Typical Performance

$V_d = 3.3V, I_d = 18mA$

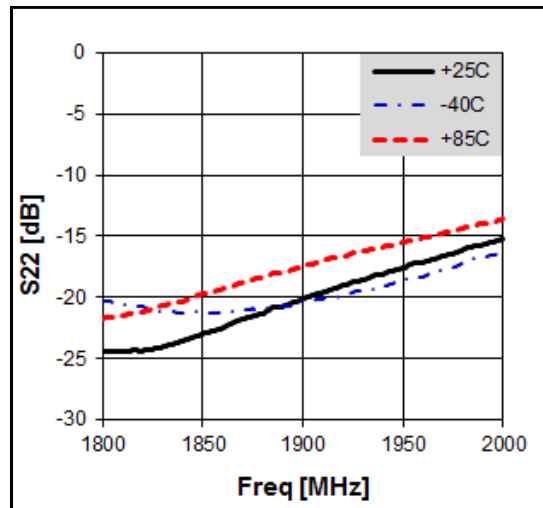
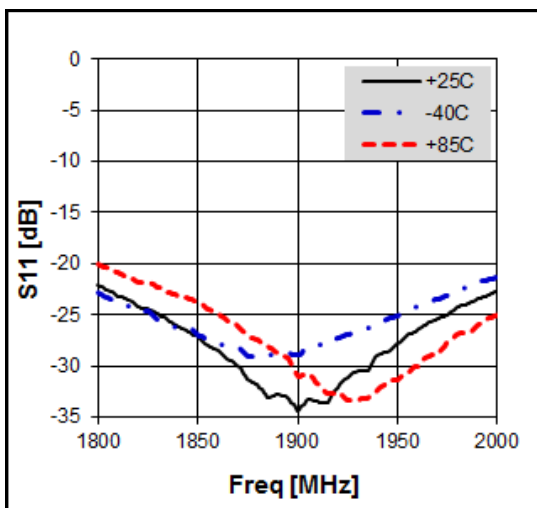

BL082

5-4000 MHz Wideband Low Noise Amplifier



$V_d = 3.3V, I_d = 18mA$

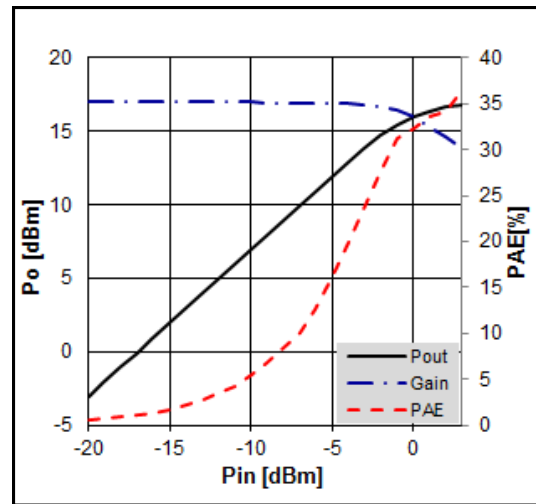
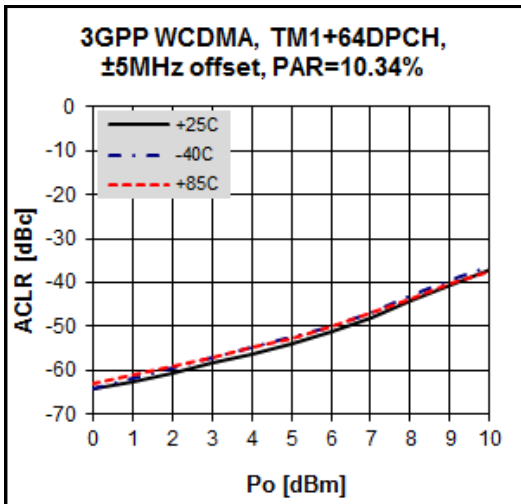
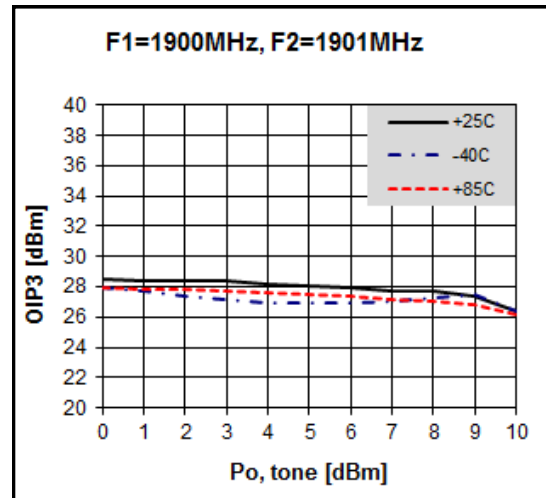
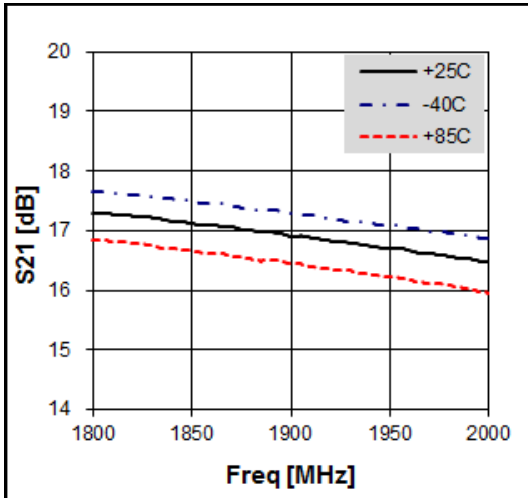

Noise Figure Temperature Performance

(V_{ds} = 3.3V, I_{ds} = 18.0mA)

Preliminary Datasheet

BL082

5-4000 MHz Wideband Low Noise Amplifier



Application Circuit: 2140 MHz

Schematic Diagram	BOM	Tolerance	
	C1	10uF	± 20%
	C2	1nF	± 5%
	C3	100pF	±5%
	C4	100pF	±5%
	C5	100pF	±5%
	C6	0.5pF	± 5%
	L1	22nH	±5%
	L2	3.3nH	±5%
	L3	3.9nH	±5%

Typical Performance

$V_d = 5V, I_d = 27mA$

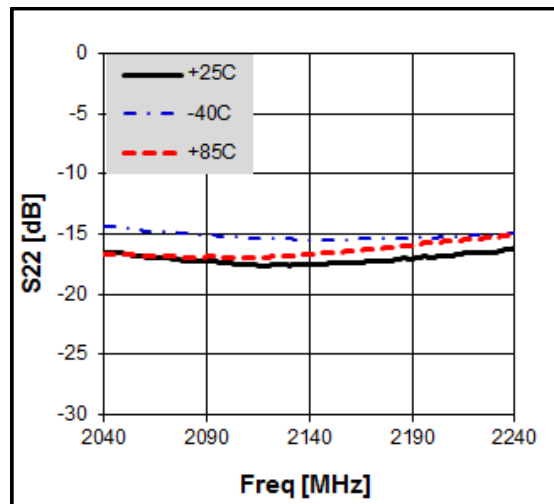
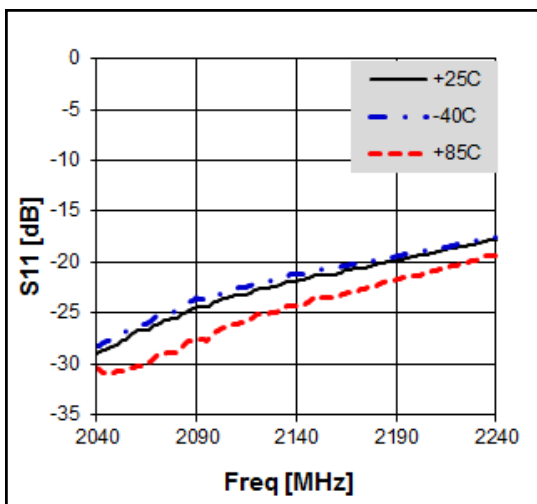

BL082

5-4000 MHz Wideband Low Noise Amplifier



Preliminary Datasheet

$V_d = 5V, I_d = 27mA$

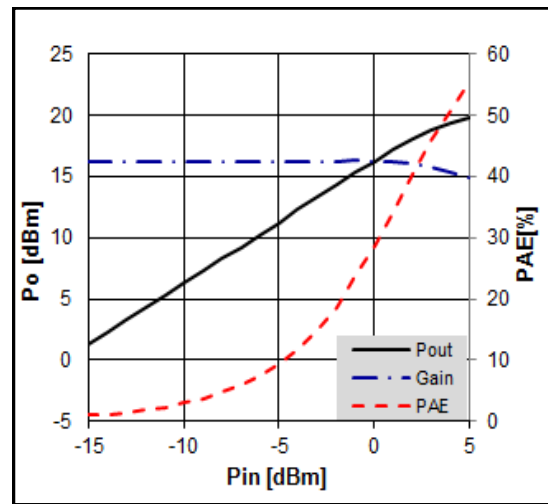
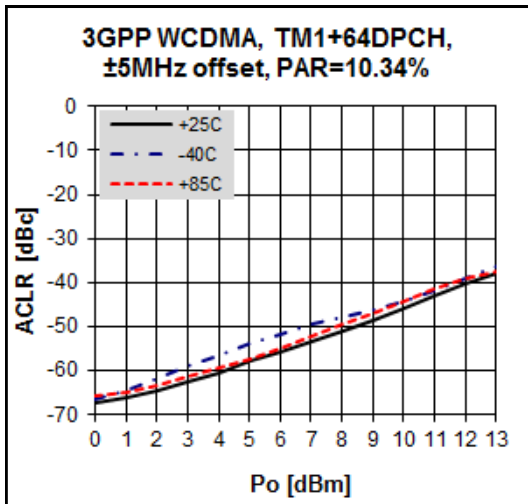
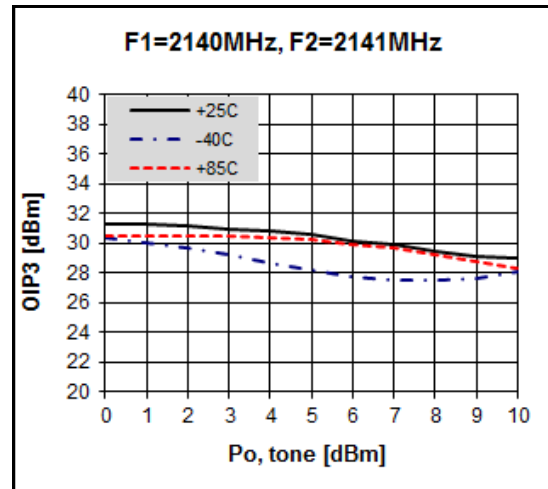
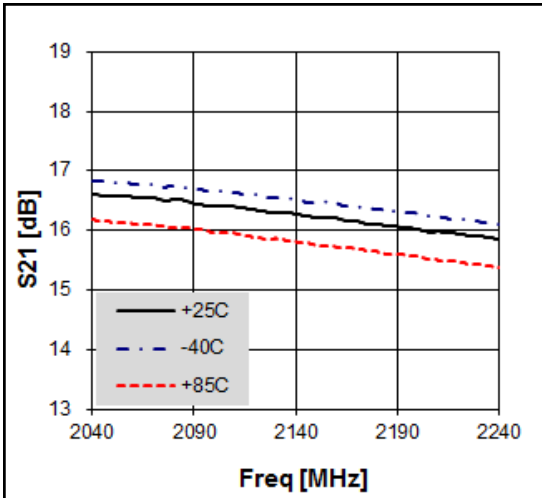

Noise Figure Temperature Performance

(V_{ds} = 5.0V, I_{ds} = 27.0mA)

BL082

5-4000 MHz Wideband Low Noise Amplifier



Application Circuit: 2140 MHz

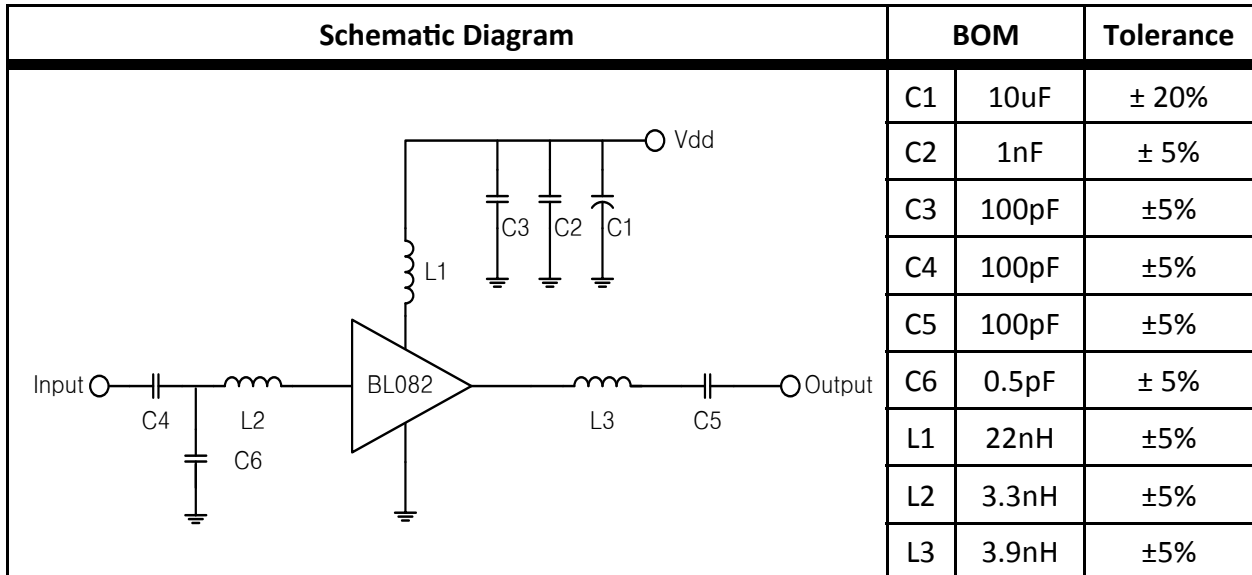

Typical Performance

$V_d = 3.3V, I_d = 18mA$

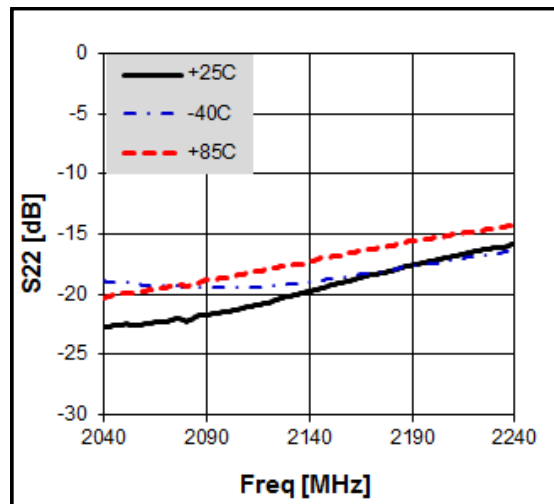
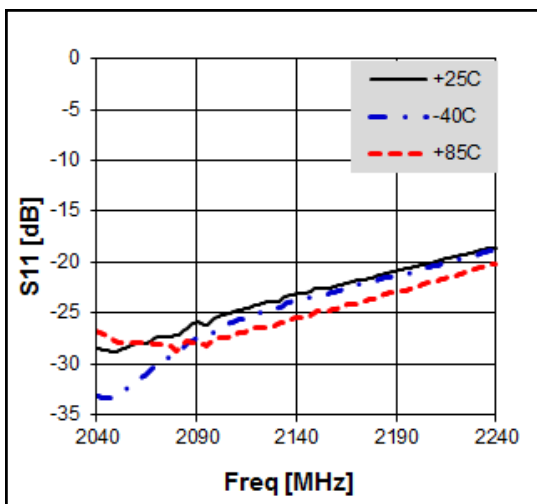

BL082

5-4000 MHz Wideband Low Noise Amplifier



$V_d = 3.3V, I_d = 18mA$

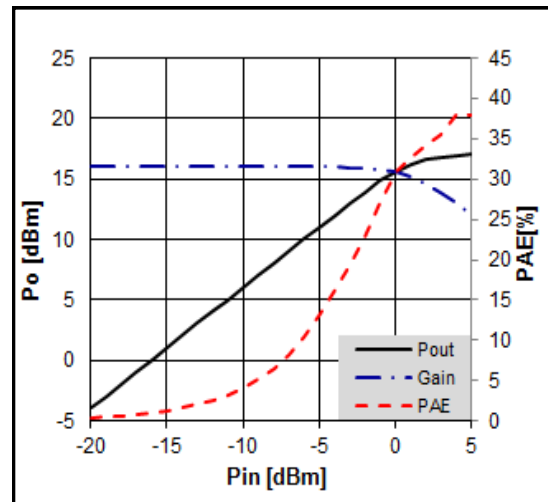
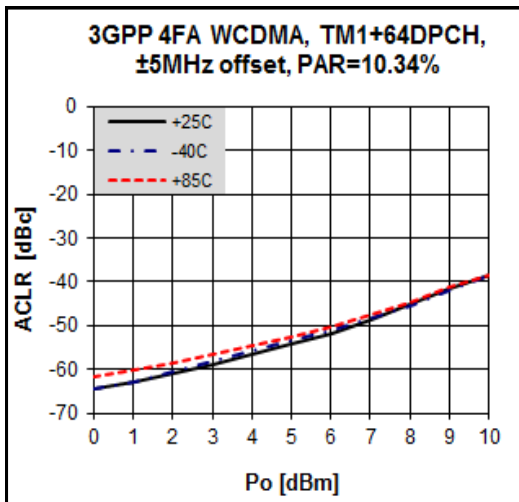
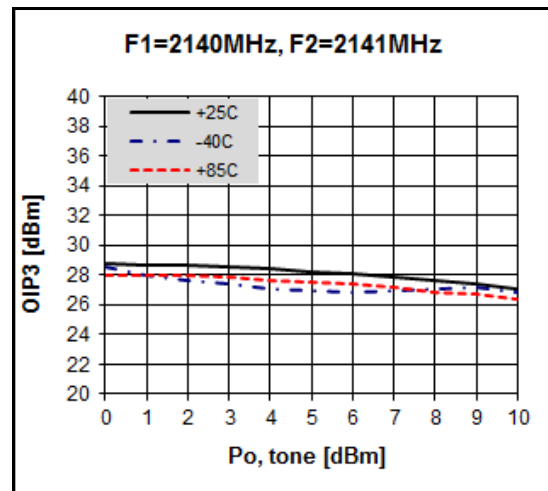
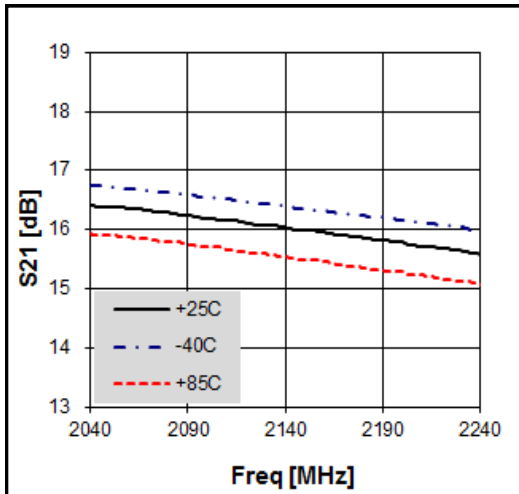

Noise Figure Temperature Performance

(V_{ds} = 3.3V, I_{ds} = 18.0mA)

Preliminary Datasheet

BL082

5-4000 MHz Wideband Low Noise Amplifier



Application Circuit: 2350 MHz

Schematic Diagram	BOM	Tolerance	
	C1	10uF	± 20%
	C2	1nF	± 5%
	C3	100pF	±5%
	C4	100pF	±5%
	C5	100pF	±5%
	C6	0.5pF	± 5%
	L1	15nH	±5%
	L2	3.3nH	±5%
	L3	3.3nH	±5%

Typical Performance

$V_d = 5V, I_d = 27mA$

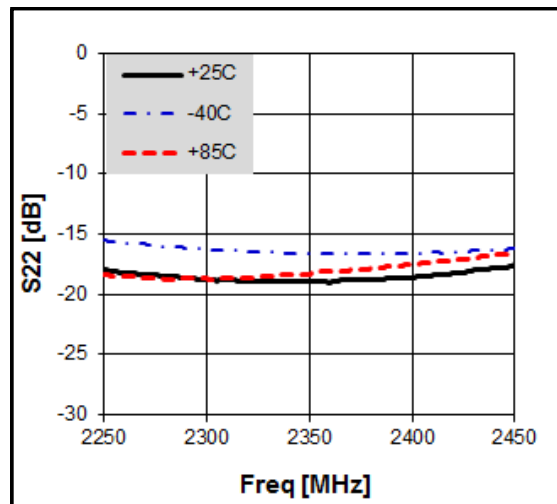
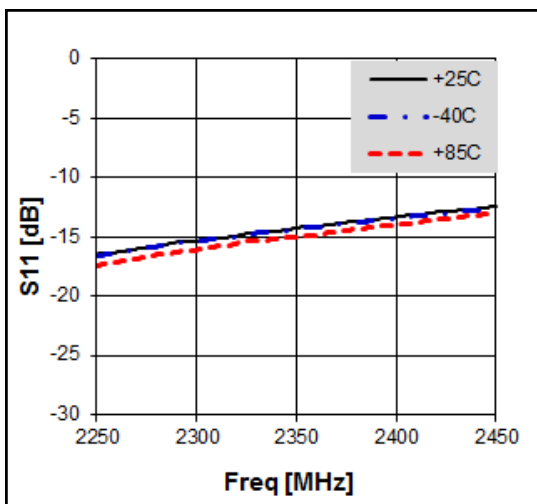

BL082

5-4000 MHz Wideband Low Noise Amplifier



$V_d = 5V, I_d = 27mA$

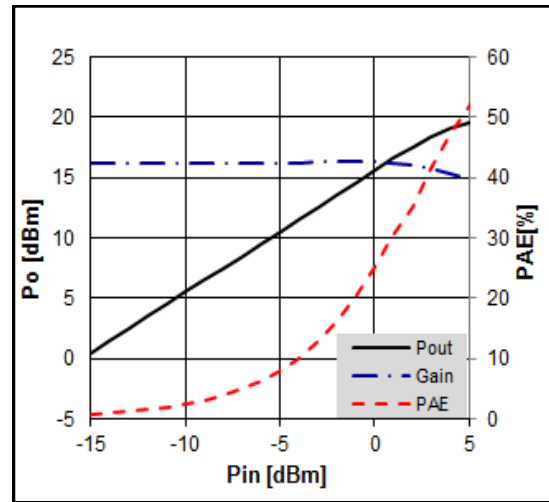
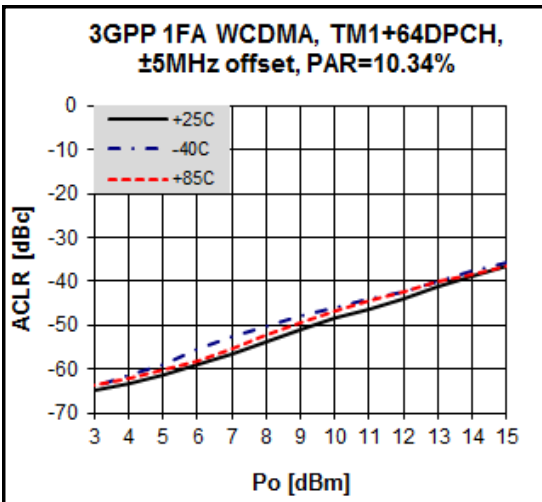
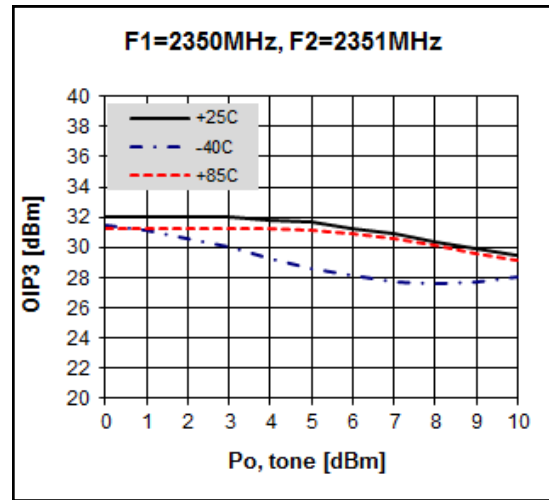
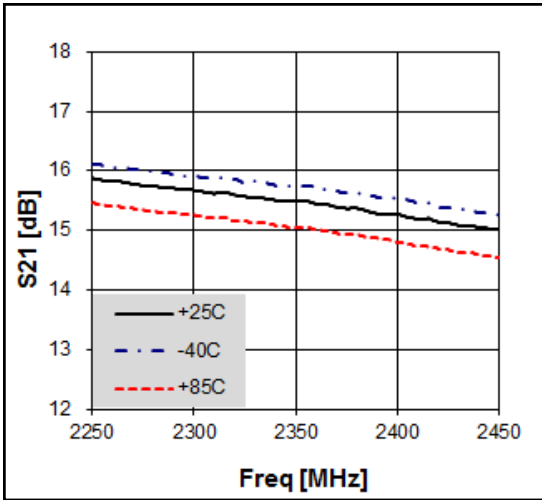

Noise Figure Temperature Performance

($V_{ds} = 5.0V, I_{ds} = 27.0mA$)

Preliminary Datasheet

BL082

5-4000 MHz Wideband Low Noise Amplifier



Application Circuit: 2350 MHz

Schematic Diagram	BOM	Tolerance	
	C1	10uF	± 20%
	C2	1nF	± 5%
	C3	100pF	±5%
	C4	100pF	±5%
	C5	100pF	±5%
	C6	0.5pF	± 5%
	L1	15nH	±5%
	L2	3.3nH	±5%
	L3	3.3nH	±5%

Typical Performance

$V_d = 3.3V, I_d = 18mA$

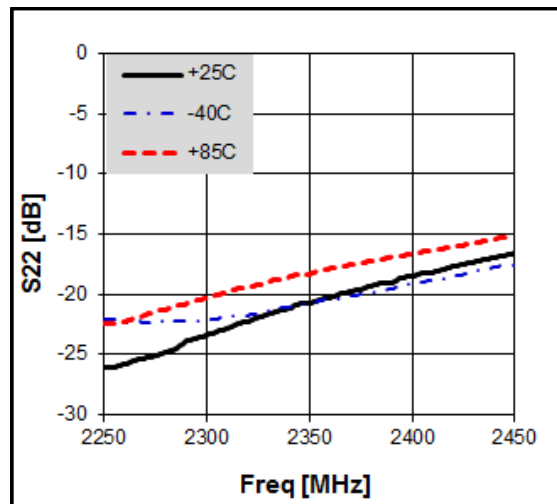
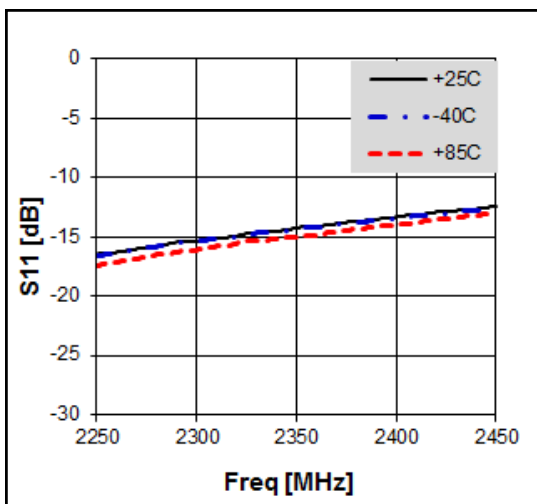

BL082

5-4000 MHz Wideband Low Noise Amplifier



$V_d = 3.3V, I_d = 18mA$

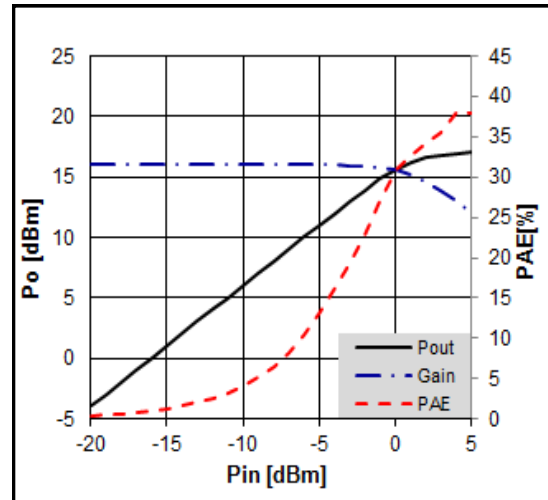
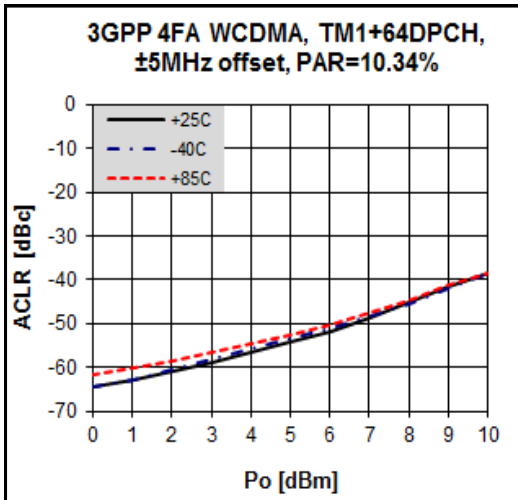
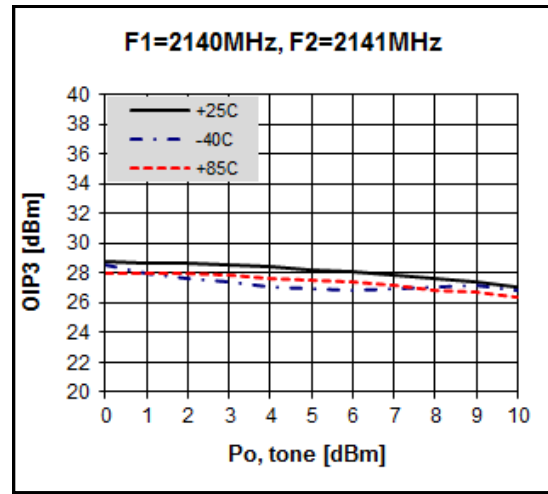
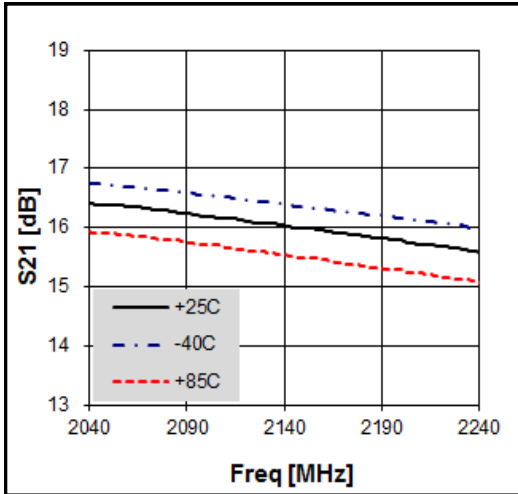

Noise Figure Temperature Performance

($V_{ds} = 3.3V, I_{ds} = 18.0mA$)

Preliminary Datasheet

BL082

5-4000 MHz Wideband Low Noise Amplifier



Application Circuit: 2650 MHz

Schematic Diagram	BOM	Tolerance	
	C1	10uF	± 20%
	C2	1nF	± 5%
	C3	100pF	±5%
	C4	22pF	±5%
	C5	22pF	±5%
	C6	0.3pF	± 5%
	L1	10nH	±5%
	L2	2.2nH	±5%
	L3	2.7nH	±5%

Typical Performance

$V_d = 5V, I_d = 27mA$

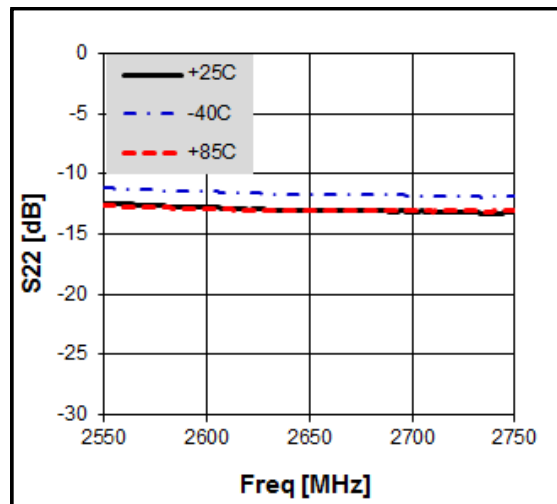
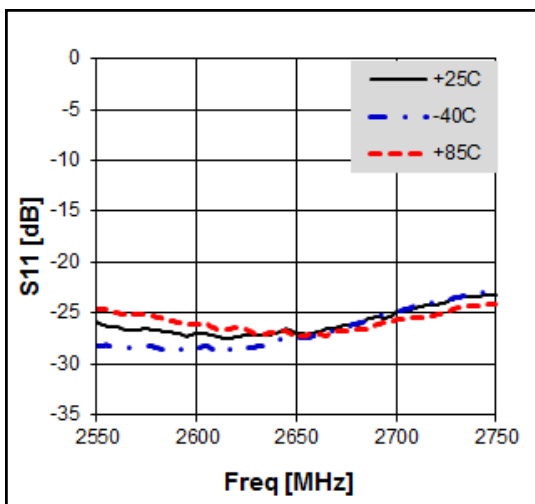

BL082

5-4000 MHz Wideband Low Noise Amplifier



$V_d = 5V, I_d = 27mA$

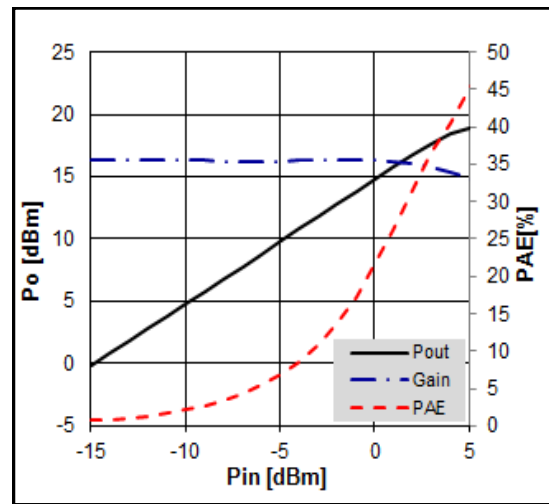
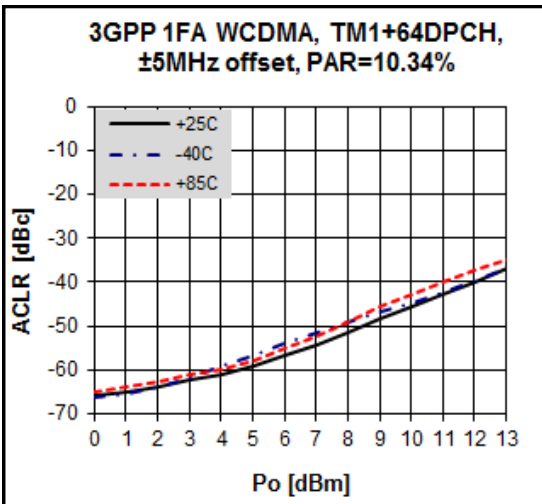
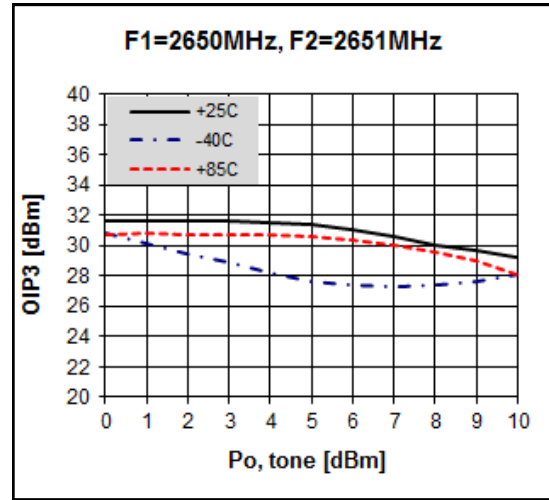
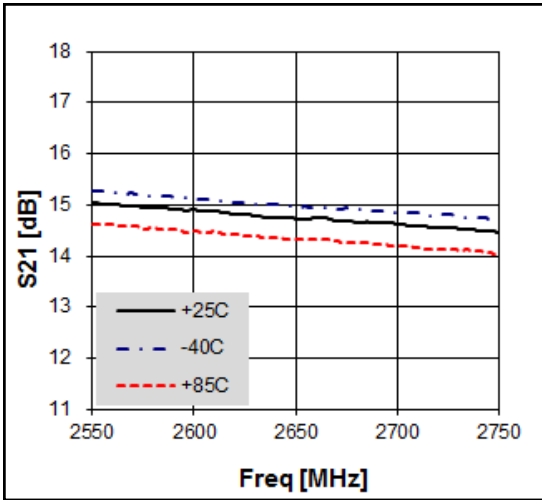

Noise Figure Temperature Performance

($V_{ds} = 5.0V, I_{ds} = 27.0mA$)

Preliminary Datasheet

BL082

5-4000 MHz Wideband Low Noise Amplifier



Application Circuit: 2650 MHz

Schematic Diagram	BOM	Tolerance	
	C1	10uF	± 20%
	C2	1nF	± 5%
	C3	100pF	±5%
	C4	22pF	±5%
	C5	22pF	±5%
	C6	0.3pF	± 5%
	L1	10nH	±5%
	L2	2.2nH	±5%
	L3	2.7nH	±5%

Typical Performance

$V_d = 3.3V, I_d = 18mA$

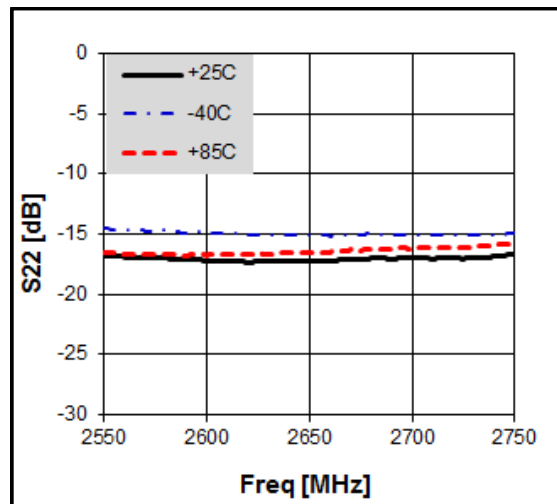
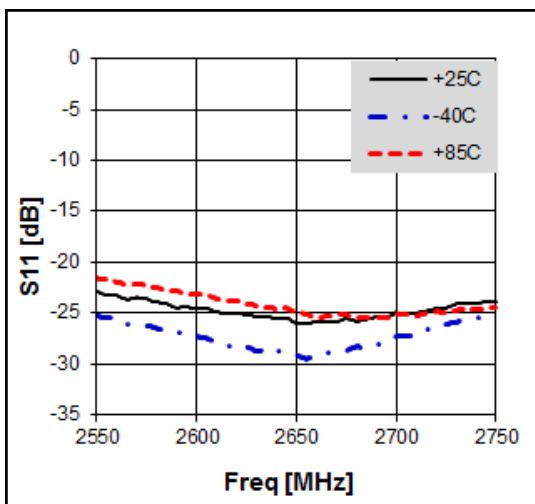

BL082



5-4000 MHz Wideband Low Noise Amplifier

$V_d = 3.3V, I_d = 18mA$

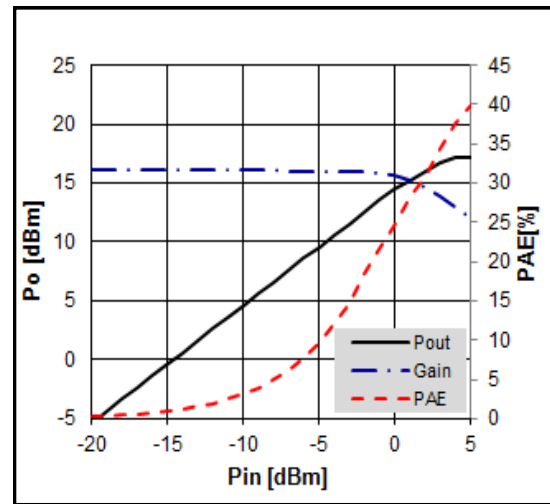
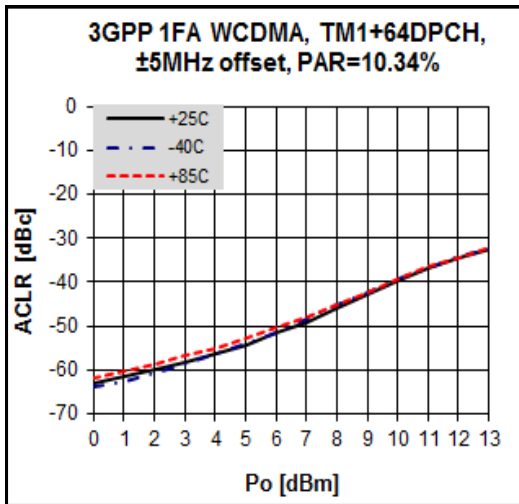
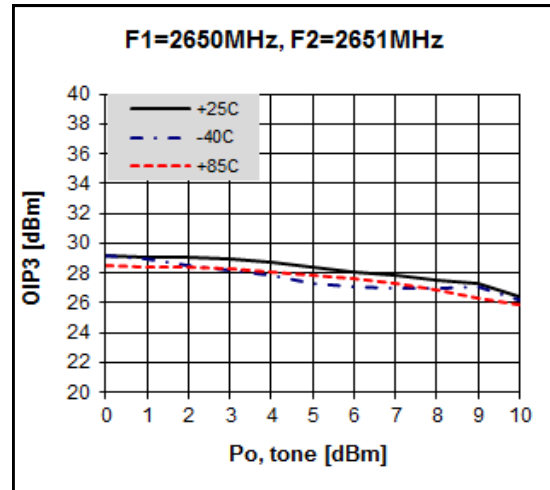
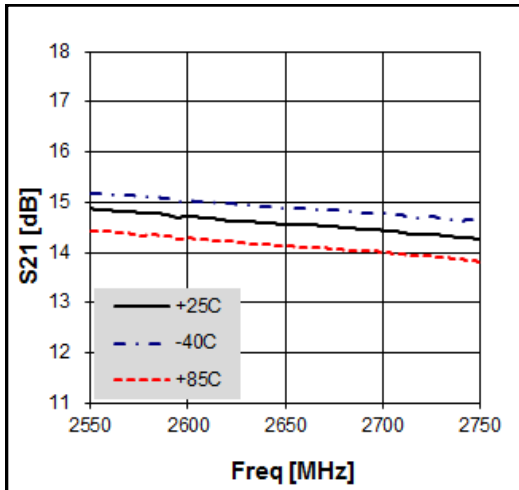

Noise Figure Temperature Performance

($V_{ds} = 3.3V, I_{ds} = 18.0mA$)

Preliminary Datasheet

BL082

5-4000 MHz Wideband Low Noise Amplifier



Package Outline Dimension

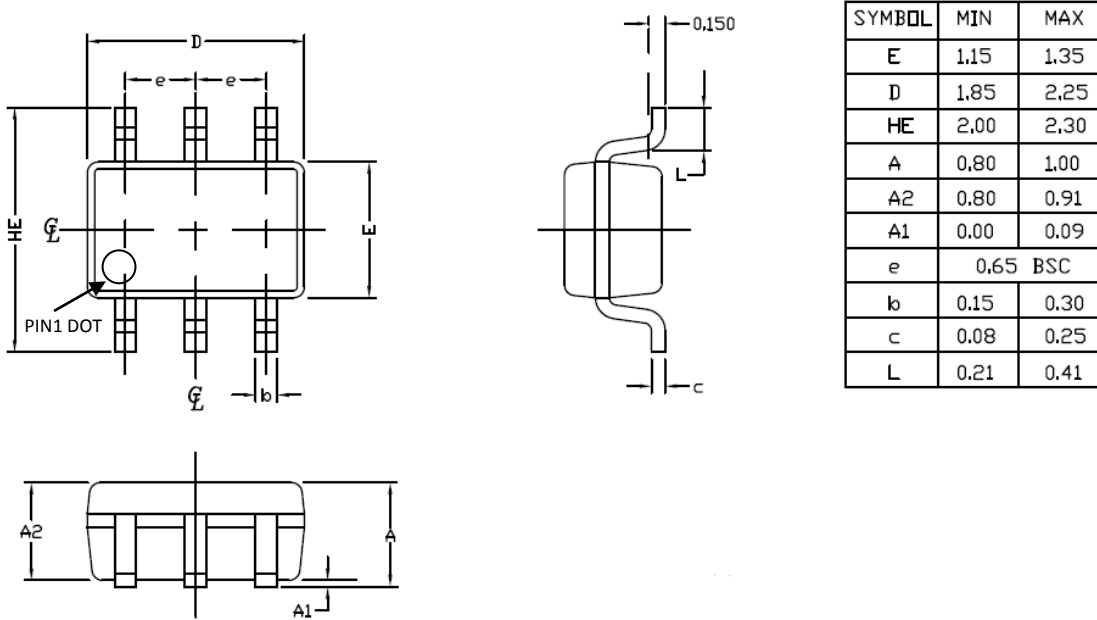

Suggested PCB Land Pattern and PAD Layout

PCB Land Pattern

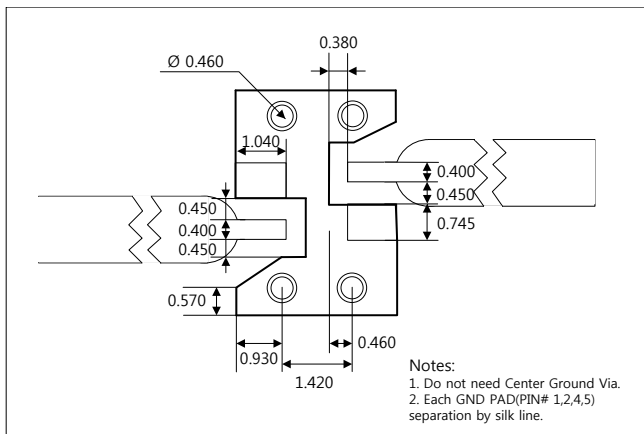

PCB Mounting

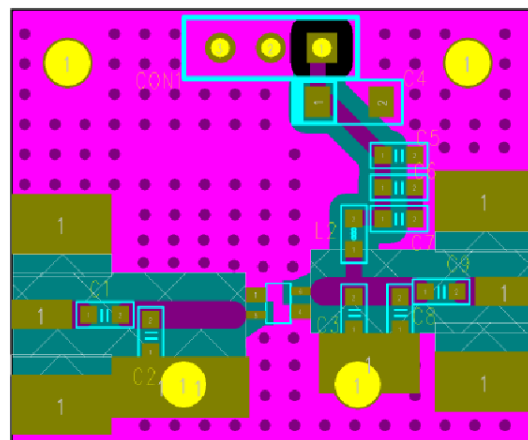

Note : All dimension _ millimeters

PCB lay out _ on BeRex website

BL082

5-4000 MHz Wideband Low Noise Amplifier



Package Marking

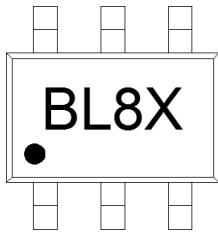

Pin 1

X = Wafer No.

Tape & Reel

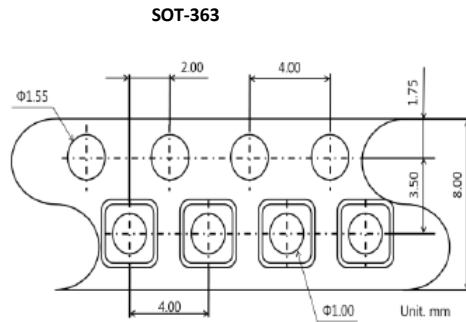

Packaging information:

- Tape Width (mm): 8
- Reel Size (inches): 7
- Device Cavity Pitch (mm): 4
- Devices Per Reel: 3000

Lead plating finish

100% Tin Matte finish

(All BeRex products undergoes a 1 hour, 150 degree C, Anneal bake to eliminate thin whisker growth concerns.)

MSL / ESD Rating

ESD Rating:	Class 0
Value:	Passes <200V
Test:	Human Body Model (HBM)
Standard:	JEDEC Standard JESD22-A114B
MSL Rating:	Level 1 at +265°C convection reflow
Standard:	JEDEC Standard J-STD-020

NATO CAGE code:

2	N	9	6	F
---	---	---	---	---