



PARA LIGHT ELECTRONICS CO., LTD.
4F, No.1, Lane 93, Chien Yi Road, Chung Ho City, Taipei, Taiwan.
Tel: 886-2-2225-3733 Fax: 886-2-2225-4800
E-mail: para@para.com.tw <http://www.para.com.tw>

DATA SHEET

PART NO. : L-314LPG6C

REV : B / 1

CUSTOMER'S APPROVAL : _____ DCC : _____

DRAWING NO. : DS-33-03-0440

DATE : 2011-11-03

Page : 1



3.0 mm DIA LED LAMP

L-314LPG6C

REV:B / 1

PACKAGE DIMENSIONS

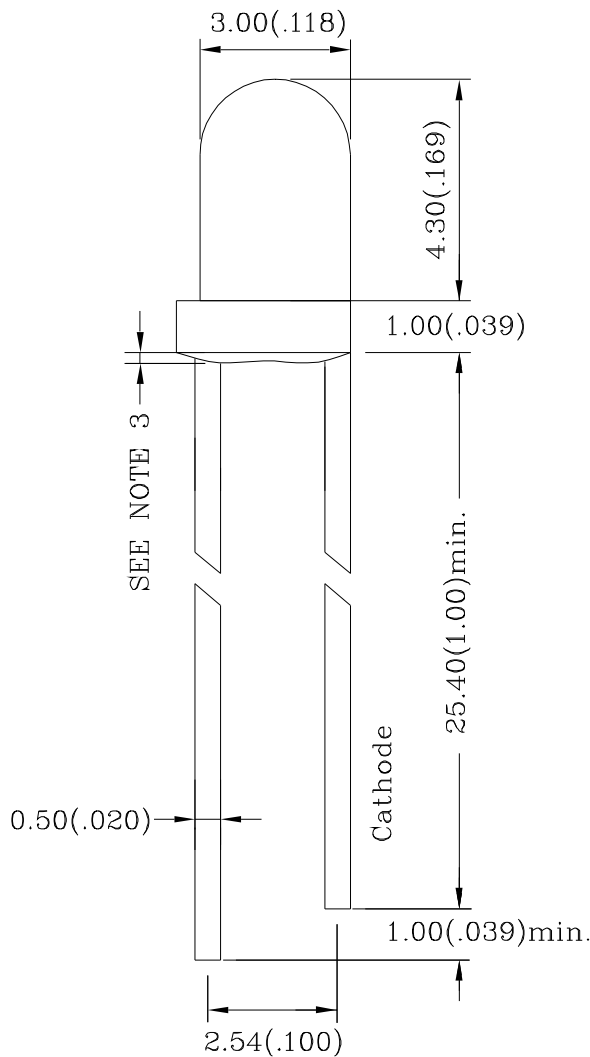
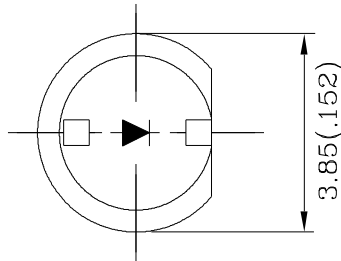

ITEM	MATERIALS
RESIN	Epoxy Resin
LEAD FRAME	Sn Plating iron Alloy

Note:

1. All Dimensions are in millimeters.
2. Tolerance is $\pm 0.25\text{mm}(0.010 \text{ "})$ Unless otherwise specified.
3. Protruded resin under flange is $0.6\text{mm}(0.024 \text{ "})$ max.
4. highlight <1500V the led can withstand the max static level when assembling or operation (HBM)



3.0 mm DIA LED LAMP

L-314LPG6C

REV:B / 1

FEATURES

- * High-brightness
- * High reliability
- * Low-voltage characteristics
- * Wide Viewing Angle
- * Pb FREE Products
- * RoHS Compliant

CHIP MATERIALS

- * Dice Material : GaInN/GaN
- * Light Color : ULTRA PURE GREEN
- * Lens Color : WATER CLEAR

ABSOLUTE MAXIMUM RATING : (Ta = 25°C)

SYMBOL	DESCRIPTION	ULTRA PURE GREEN	UNIT
PD	Power Dissipation Per Chip	120	mW
VR	Reverse Voltage Per Chip	5	V
IF	Average Forward Current Per Chip	30	mA
-	Derating Linear From 25°C Per Chip	0.4	mA/°C
Topr	Operating Temperature Range	-40°C to 85°C	
Tstg	Storage Temperature Range	-40°C to 85°C	

ELECTRO-OPTICAL CHARACTERISTICS : (Ta = 25°C)

SYMBOL	DESCRIPTION	TEST CONDITION	MIN.	TYP.	MAX.	UNIT
VF	Forward Voltage	IF = 20mA		3.7	4.0	V
IR	Reverse Current	VR = 5V			100	μA
λD	Dominant Wavelength	IF = 20mA		525		nm
Δλ	Spectral Line Half-Width	IF = 20mA		22		nm
2θ1/2	Half Intensity Angle	IF = 20mA		20		deg
Iv	Luminous Intensity	IF = 20mA		5000		mcd



3.0 mm DIA LED LAMP

L-314LPG6C

REV:B / 1

■ Forward Voltage vs. Forward Current

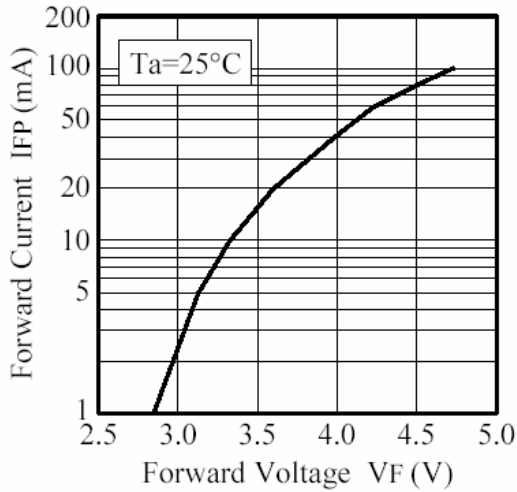

■ Ta= 25°C
Luminous Intensity VS. Forward Current (Mcd)

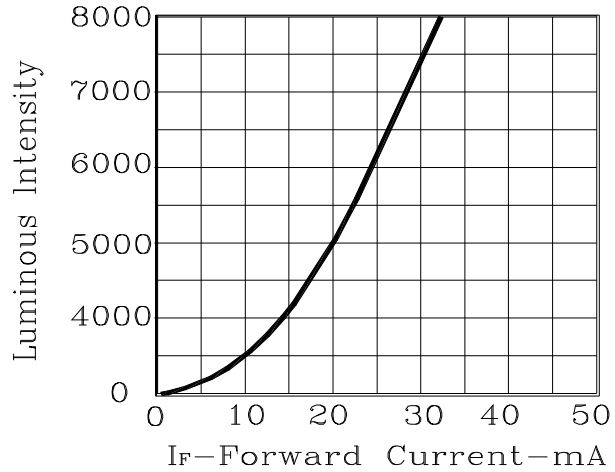

■ Duty Ratio vs. Allowable Forward Current

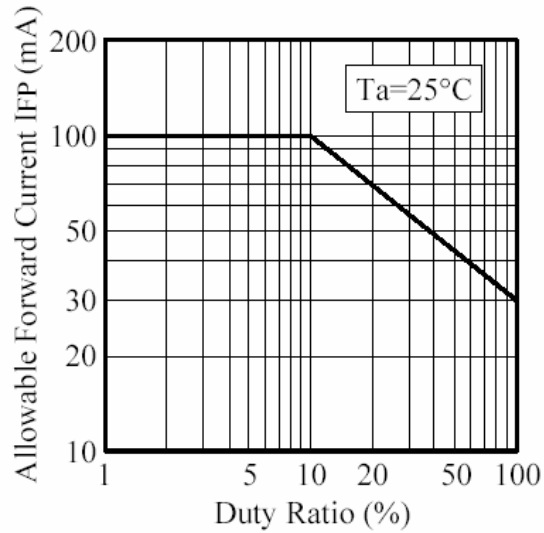

■ Ambient Temperature vs. Forward Voltage

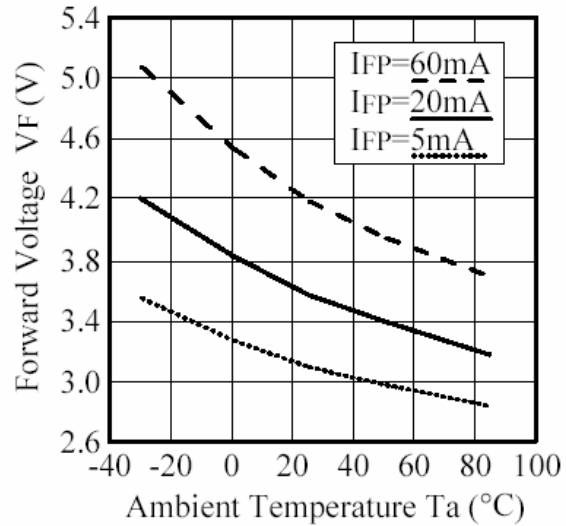



3.0 mm DIA LED LAMP

L-314LPG6C

REV:B / 1

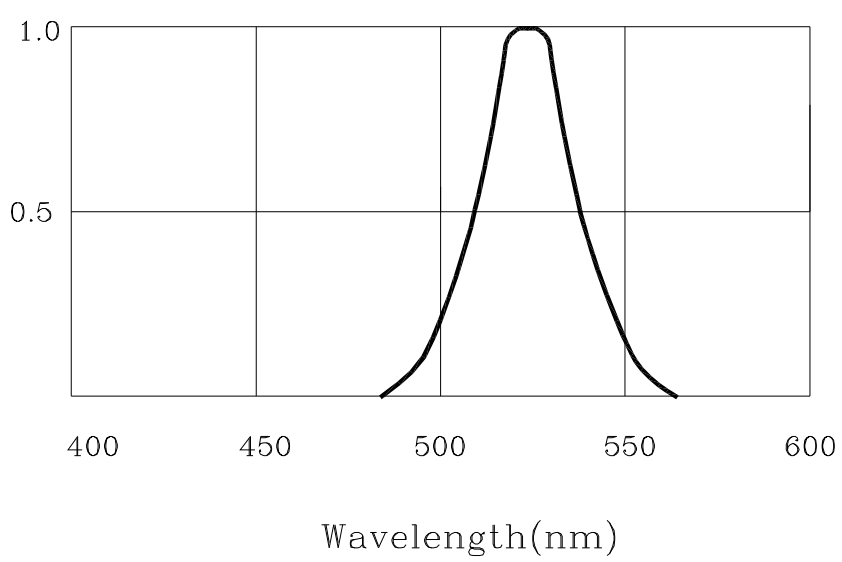
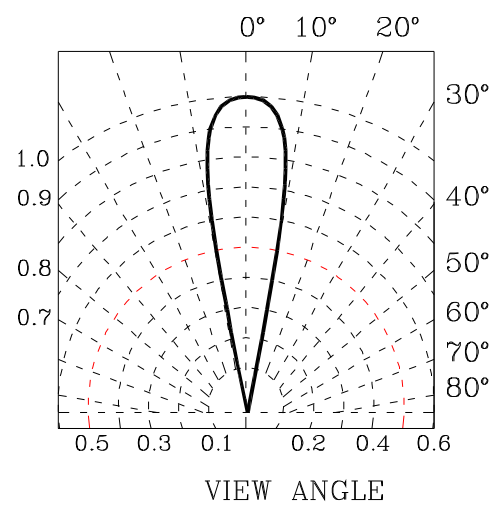



3.0 mm DIA LED LAMP

L-314LPG6C

REV:B / 1

Label Explanation

		光鼎电子股份有限公司 PARA LIGHT ELECTRONICS CO.,LTD.	
PARA NO. :			
LOT NO. :		INSPECTED	
BIN :			
Q' TY :		PCS	
N. W :		g	

PARA NO. : Refer to p14

LOT NO. : E L L 4 7 0009
 A B C D E F

- A---E: For series number
- B---L: Local F: Foreign
- C---L: LAMP
- D---Year
- E---Month
- F---SPEC.

BIN : actual code will be base on page 14 specification

N'W : Net Weight



3.0 mm DIA LED LAMP

L-314LPG6C

REV: B / 1

SOLDERING

METHOD	SOLDERING CONDITIONS	REMARK
DIP SOLDERING	Bath temperature: 240°C Immersion time: with 3 sec, 1 time	<ul style="list-style-type: none"> – Solder no closer than 3mm from the base of the package – Using soldering flux, "RESIN FLUX" is recommended. – Attached data of temperature cure for your reference
SOLDERING IRON	Soldering iron: 30W or smaller Temperature at tip of iron: 300°C or lower Soldering time: within 5 sec.	<ul style="list-style-type: none"> – During soldering, take care not to press the tip of iron against the lead. (To prevent heat from being transferred directly to the lead, hold the lead with a pair of tweezers while soldering

1) When soldering the lead of LED in a condition that the package is fixed with a panel (See Fig.1), be careful not to stress the leads with iron tip.

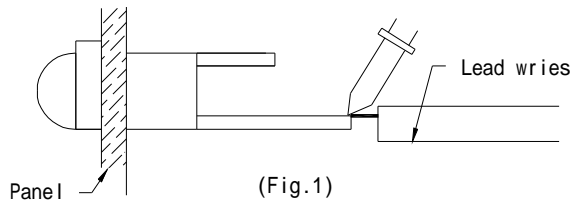

2) When soldering wire to the lead, work with a Fig (See Fig.2) to avoid stressing the package.

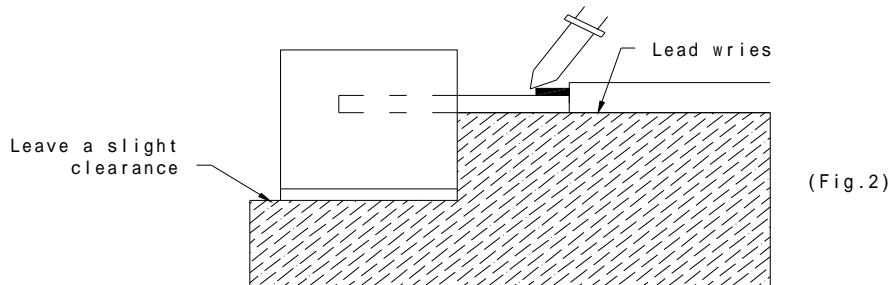

Regarding solution in the tinning oven for product-tinning, compound sub-solution made of tin & copper and silver is proposed with the temperature of Celsius 260. The proportion of the alloyed solution is tin 95.5: copper 3.5: silver 0.5 by percentage. The time of tinning is constantly 3 seconds.



3.0 mm DIA LED LAMP

L-314LPG6C

REV:B / 1

- 3) Similarly, when a jig is used to solder the LED to PC board, take care as much as possible to avoid steering the leads (See Fig.3).

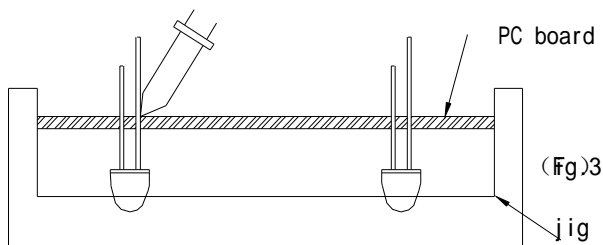

- 4) Repositioning after soldering should be avoided as much as possible. If inevitable, be sure to preserve the soldering conditions with irons stated above: select a best-suited method that assures the least stress to the LED.
- 5) Lead cutting after soldering should be performed only after the LED temperature has returned to normal temperature.

— STORAGE

- 1) The LEDs should be stored at 30°C or less and 70% RH or less after being shipped from PARA and the storage life limits are 3 months .
- 2) PARA LED lead frames are comprised of a stannum plated iron alloy. The silver surface may be affected by environments which contain corrosive gases and so on. Please avoid conditions which may cause the LEDs to corrode, tarnish or discolor. This corrosion or discoloration may cause difficulty during soldering operations. It is recommended that the LEDs be used as soon as possible.

Please avoid rapid transitions in ambient temperature, especially, in high humidity environments where condensation can occur.

— STATIC ELECTRICITY

- 1) Static electricity or surge voltage damages the LEDs.
It is recommended that a wrist band or an anti-electrostatic glove be used when handling the LEDs.
- 2) All devices, equipment and machinery must be properly grounded. It is recommended that measures be taken against surge voltage to the equipment that mounts the LEDs.
- 3) When inspecting the final products in which LEDs were assembled, it is recommended to check whether the assembled LEDs are damaged by static electricity or not. It is easy to find static-damaged LEDs by a light-on test or a VF test at a lower current (below 1mA is recommended).
- 4) Damaged LEDs will show some unusual characteristics such as the leak current remarkably increases, the forward voltage becomes lower, or the LEDs do not light at the low current .

Criteria : (VF>2.0V at IF=0.5mA)



3.0 mm DIA LED LAMP

L-314LPG6C

REV:B / 1

LED MOUNTING METHOD

4) When mounting the LED by using a case, as shown Fig.4, ensure that the mounting holds on the PC board match the pitch of the leads correctly-tolerance of dimensions of the respective components including the LED should be taken into account especially when designing the case, PC board, etc. to prevent pitch misalignment between the leads and board holes, the diameter of the board holes should be slightly larger than the size of the lead. Alternatively, the shape of the holes should be made oval. (See Fig.4)

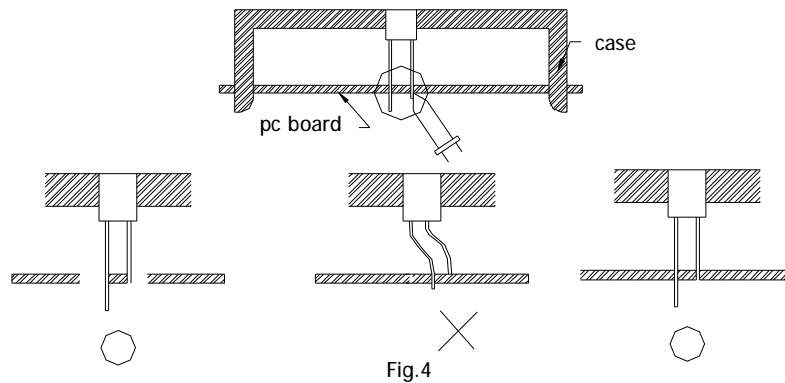

5) Use LEDs with stand-off (Fig.5) or the tube or spacer made of resin (Fig.6) to position the LEDs.

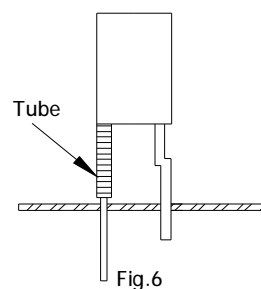
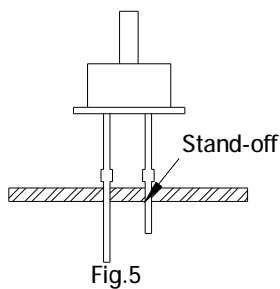



3.0 mm DIA LED LAMP

L-314LPG6C

REV:B / 1

FORMED LEAD

- 1) The lead should be bent at a point located at least 2mm away from the package. Bending should be performed with base fixed means of a jig or pliers (Fig.7)

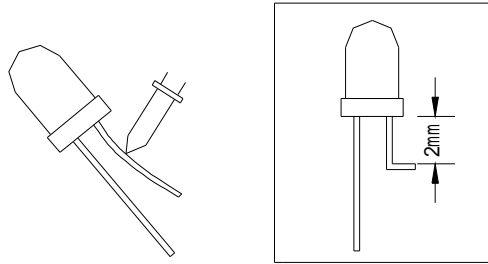

Fig.7

- 2) Forming lead should be carried out prior to soldering and never during or after soldering.
- 3) Form the lead to ensure alignment between the leads and the hole on board, so that stress against the LED is prevented. (Fig.8)

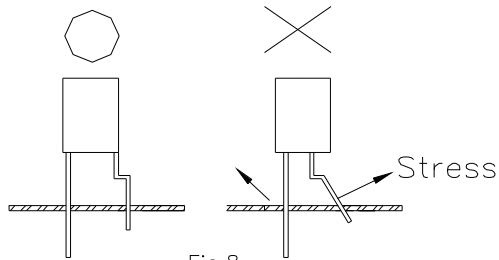

Fig.8

LEAD STRENGTH

- 1) Bend strength
Do not bend the lead more than twice. (Fig.9)

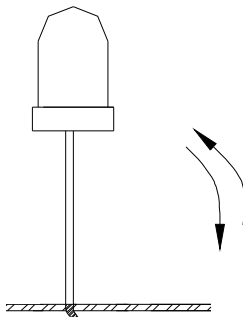

Fig.9



3.0 mm DIA LED LAMP

L-314LPG6C

REV:B / 1

2) Tensile strength (@Room Temperature)

If the force is 1kg or less, there will be no problem. (Fig.10)



–HEAT GENERATION

- 1) Thermal design of the end product is of paramount importance. Please consider the heat generation of the LED when making the system design. The coefficient of temperature increase per input electric power is affected by the thermal resistance of the circuit board and density of LED placement on the board, as well as other components. It is necessary to avoid intense heat generation and operate within the maximum ratings given in this specification.

The operating current should be decided after considering the ambient maximum temperature of LEDs.

–CHEMICAL RESISTANCE

- 1) Avoid exposure to chemicals as it may attack the LED surface and cause discoloration.
- 2) When washing is required, refer to the following table for the proper chemical to be used.
(Immersion time: within 3 minutes at room temperature.)

SOLVENT	ADAPTABILITY
Freon TE	⊕
Chloroethene	×
Isopropyl Alcohol	⊕
Thinner	×
Acetone	×
Trichloroethylene	×

⊕--Usable ×--Do not use.

NOTE: Influences of ultrasonic cleaning of the LED resin body differ depending on such factors as the oscillator output, size of the PC board and the way in which the LED is mounted. Therefore, ultrasonic cleaning should only be performed after confirming there is no problem by conducting a test under practical.



3.0 mm DIA LED LAMP

L-314LPG6C

REV:B / 1

—OTHERS

- 1) Care must be taken to ensure that the reverse voltage will not exceed the absolute maximum rating when using the LEDs with matrix drive.
- 2) Flashing lights have been known to cause discomfort in people; you can prevent this by taking precautions during use. Also, people should be cautious when using equipment that has had LEDs incorporated into it.
- 3) The LEDs described in this brochure are intended to be used for ordinary electronic equipment (such as office equipment, communications equipment, measurement instruments and household appliances). Consult PARA's sales staff in advance for information on the applications in which exceptional quality and reliability are required , particularly when the failure or malfunction of the LEDs may directly jeopardize life or health (such as for airplanes, aerospace, submersible repeaters, nuclear reactor control systems, automobiles, traffic control equipment, life support systems and safety devices).
- 4) User shall not reverse engineer by disassembling or analysis of the LEDs without having prior written consent from PARA. When defective LEDs are found, the User shall inform PARA directly before disassembling or analysis.
- 5) The formal specifications must be exchanged and signed by both parties before large volume purchase begins.
- 6) The appearance and specifications of the product may be modified for improvement without notice.



3.0 mm DIA LED LAMP

L-314LPG6C

REV: B / 1

Bin Code List

Forward Voltage (VF), Unit:v@20mA		
Bin Code	Min	Max
V1	2.88	3.33
V2	3.07	3.54
V3	3.16	3.74
V4	3.46	3.95
V5	3.65	4.0

Tolerance of each bin are ± 0.1 Volt

Dominant Wavelength(ID), Unit:nm@20mA		
Bin Code	Min	Max
D3	509	516
D4	514	521
D5	519	526
D6	524	531
D7	529	536

Luminous Intensity(IV), Unit:mcd@20mA		
Bin Code	Min	Max
J	2110	2950
K	2950	4130
L	4130	5780
M	5780	8090
N	8090	11330

Tolerance of each bin are $\pm 15\%$



3.0 mm DIA LED LAMP

L-314LPG6C

REV:B / 1

LED Lamps:

L - [5] [1] [3] [Y] [D] []

Special Operation & Other

Len Color

- D : Color Diffused
- T : Color Transparent
- C : Water Clear
- W : White Diffused

- G : Gap Green
- E : GaAs/Gap Orange & Hi-effi-Red
- H : Gap Red
- SR,LR,UR : GaAlAs Red
- Y : GaAsP/Gap Yellow
- VG3 : GaAlInP Green
- HUR : GaAlInP Red
- LE,VE : GaAlInP Orange
- LY,UY,VY : GaAlInP Yellow
- SPG4,LPG4 : GaInN Green
- UB5,VB5 : GaInN Blue
- UW5,VW5 : GaInN White

- 1 : 0.8"Length with Stand-off
- 2 : 0.5" Length Standard
- 3 : 1"Length with Large Reflector
- 4 : 1"Length with Small Reflector
- 5 : 1"WITH 3 Leads for Dual Color
- 7 : 1"WITH 2 Leads for Dual Color
- 9 : 1"WITH 3 Leads for Dual Color

Package Type (Style)