



PARA LIGHT ELECTRONICS CO., LTD.
4F, No.1, Lane 93, Chien Yi Road, Chung Ho City, Taipei, Taiwan
Tel: 886-2-2225-3733 Fax: 886-2-2225-4800
E-mail: para@para.com.tw <http://www.para.com.tw>

DATA SHEET

PART NO. : LH322006B

REV : A / 0

CUSTOMER'S APPROVAL : _____ DCC : _____



3.0mm LED LAMP WITH H308 HOLDER

LH322006B

REV:A / 0

PACKAGE DIMENSIONS

Color
Description

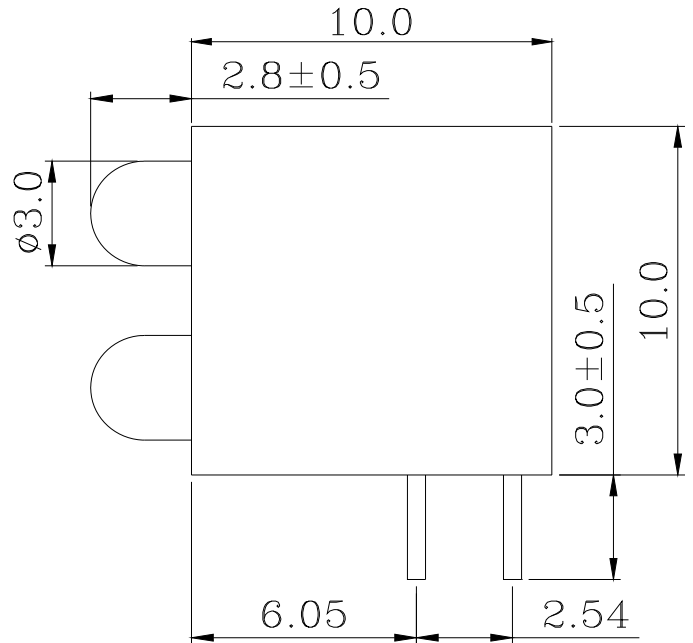
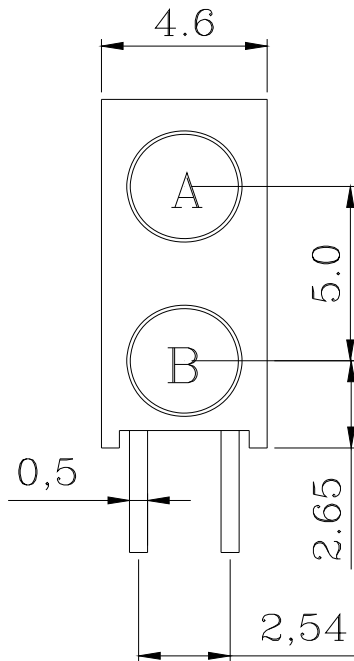
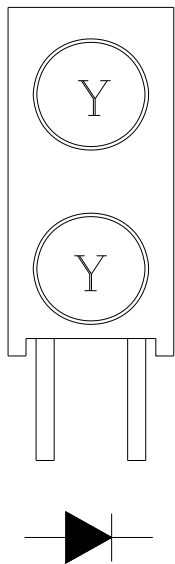

Note:

1. All Dimensions are in millimeters.
2. Tolerance is $\pm 0.25\text{mm}$ (0.010 ") Unless otherwise specified.
3. Protruded resin under flange is 1.5mm (0.059 ") max.
4. Lead spacing is measured where the leads emerge from the package.
5. Specification are subject to change without notice
6. The lamps have sharp and hard points that may injure human eyes or fingers etc., so please pay enough care in the handling.
7. A=B=L3524YD-AH



3.0mm LED LAMP WITH H308 HOLDER

LH322006B

REV:A / 0

FEATURES

- * 3.0mm DIA LED LAMP
- * LOW POWER CONSUMPTION.
- * I.C. COMPATIBLE.
- * LONG LIFE SOLID STATE RELIABILITY.
- * PB FREE PRODUCTS(Compliant with EU's RoHS.)

CHIP MATERIALS

- * Dice Material : GaAsP/GaP
- * Light Color : Yellow
- * Lens Color : Yellow Diffused

ABSOLUTE MAXIMUM RATING : (Ta = 25°C)

SYMBOL	PARAMETER	Yellow	UNIT
PAD	Power Dissipation	78	mW
VR	Reverse Voltage	5	V
IF	Average Forward Current	30	mA
IPF	Peak Forward Current Per Chip (Duty=0.1,1KHz)	120	mA
—	Derating Linear From 25°C	0.40	mA/°C
Topr	Operating Temperature Range	-25°C to 85°C	
Tstg	Storage Temperature Range	-40°C to 85°C	

ELECTRO-OPTICAL CHARACTERISTICS : (Ta = 25°C)

SYMBOL	DESCRIPTION	TEST	MIN.	TYP.	MAX.	UNIT
Vf	Forward Voltage	IF=20mA		2.2	2.6	V
IR	Reverse Current	VR=5V			100	μA
λD	Dominant Wavelength	IF=20mA		587		nm
Δλ	Spectral Line Half-Width	IF=20mA		30		nm
2θ 1/2	Half Intensity Angle	IF=20mA		80		deg
Iv	Luminous Intensity	IF=20mA		20		mcd



3.0mm LED LAMP WITH H308 HOLDER

LH322006B

REV:A / 0

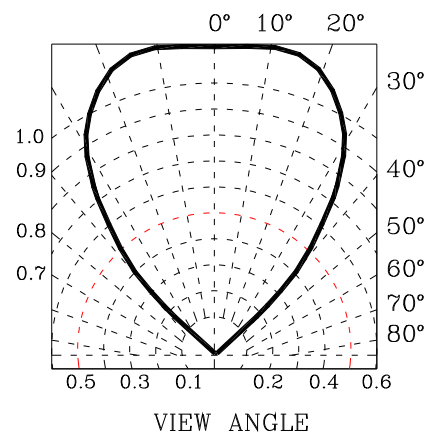
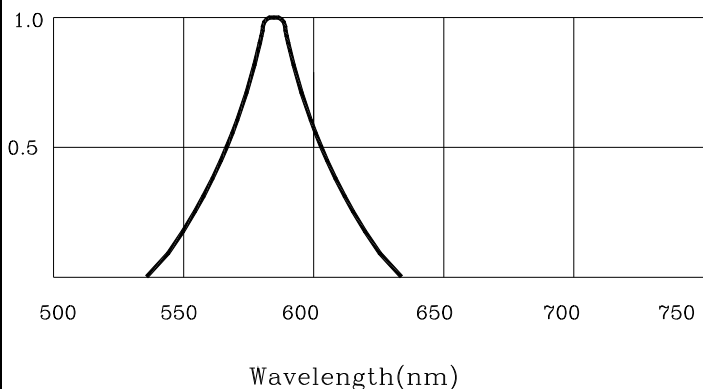
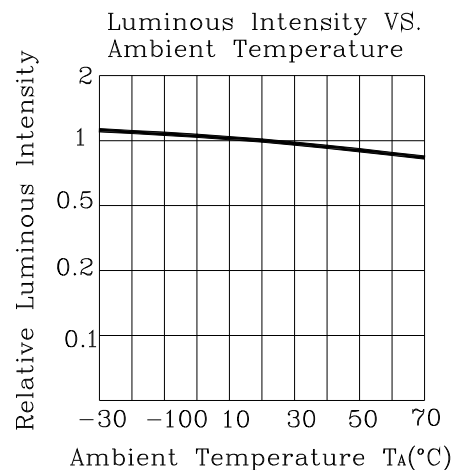
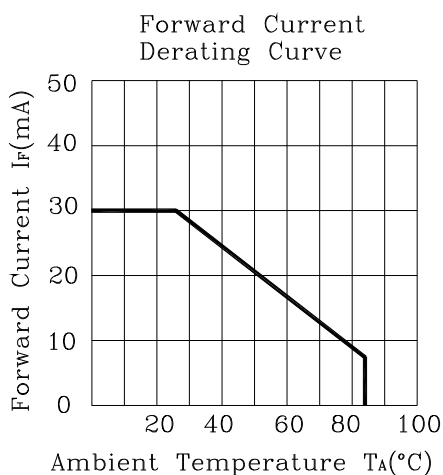
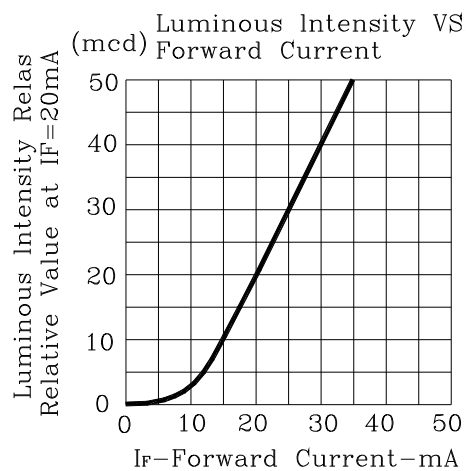
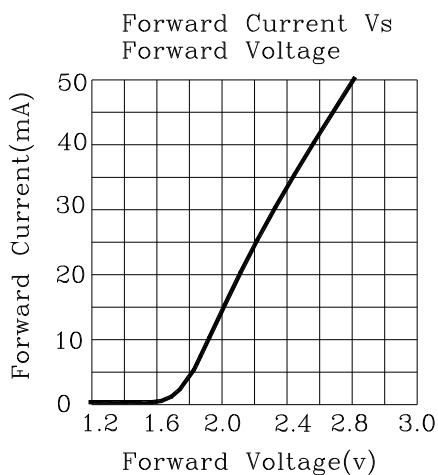



3.0mm LED LAMP WITH H308 HOLDER

LH322006B

REV:A / 0

Label Explanation

 光鼎电子股份有限公司 PARA LIGHT ELECTRONICS CO.,LTD.	
PARA NO. :	
LOT NO. :	INSPECTED
BIN :	
Q' TY :	PCS
N. W :	g

PARA NO. : Refer to p13

LOT NO. : E L L 4 7 0009

A B C D E F

A---E: For series number

B---L: Local F: Foreign

C---L: LAMP

D---Year

E---Month

F---SPEC.

N'W : Net Weight



3.0mm LED LAMP WITH H308 HOLDER

LH322006B REV:A / 0

•SOLDERING

METHOD	SOLDERING CONDITIONS	REMARK
DIP SOLDERING	Bath temperature: 250°C Immersion time: with 5 sec, 1 time	<ul style="list-style-type: none"> Solder no closer than 3mm from the base of the package Using soldering flux, "RESIN FLUX" is recommended. Attached data of temperature cure for your reference
SOLDERING IRON	Soldering iron: 30W or smaller Temperature at tip of iron: 300°C or lower Soldering time: within 3 sec.	<ul style="list-style-type: none"> During soldering, take care not to press the tip of iron against the lead. To prevent heat from being transferred directly to the lead, hold the lead with a pair of tweezers while soldering

1) When soldering the lead of LED in a condition that the package is fixed with a panel (See Fig.1), be careful not to stress the leads with iron tip.

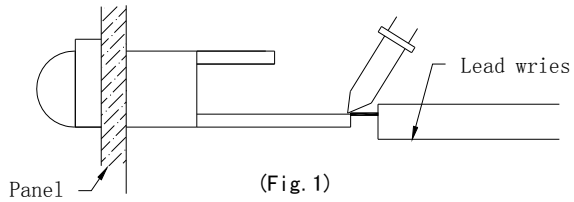

2) When soldering wire to the lead, work with a Fig (See Fig.2) to avoid stressing the package.

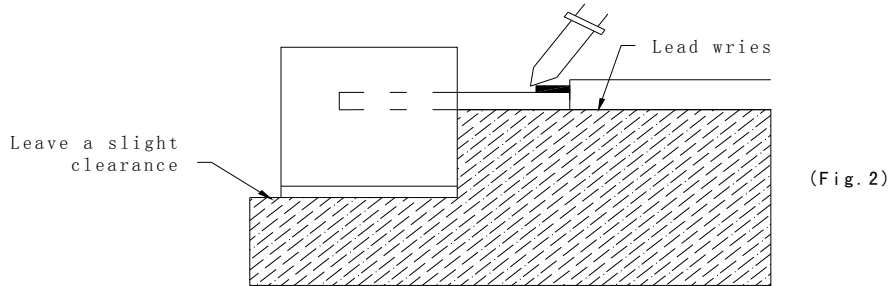

Regarding solution in the tinning oven for product-tinning, compound sub-solution made of tin & copper and silver is proposed with the temperature of Celsius 260. The proportion of the alloyed solution is tin 95.5: copper 3.5: silver 0.5 by percentage. The time of tinning is constantly 3 seconds.



3.0mm LED LAMP WITH H308 HOLDER

LH322006B

REV:A / 0

3) Similarly, when a jig is used to solder the LED to PC board, take care as much as possible to avoid steering the leads (See Fig.3).

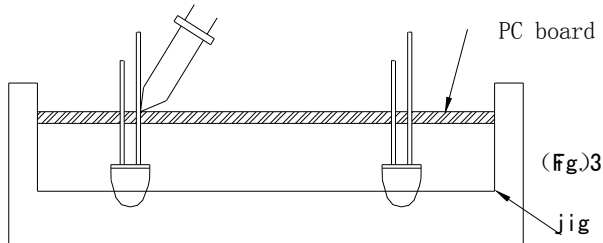

- 4) Repositioning after soldering should be avoided as much as possible. If inevitable, be sure to preserve the soldering conditions with irons stated above: select a best-suited method that assures the least stress to the LED.
- 5) Lead cutting after soldering should be performed only after the LED temperature has returned to normal temperature.

● STORAGE

- 1) The LEDs should be stored at 30°C or less and 70% RH or less after being shipped from PARA and the storage life limits are 3 months .
- 2) PARA LED lead frames are comprised of a stannum plated iron alloy. The silver surface may be affected by environments which contain corrosive gases and so on. Please avoid conditions which may cause the LEDs to corrode, tarnish or discolor. This corrosion or discoloration may cause difficulty during soldering operations. It is recommended that the LEDs be used as soon as possible.

Please avoid rapid transitions in ambient temperature, especially, in high humidity environments where condensation can occur.

•LED MOUNTING METHOD

3) When mounting the LED by using a case, as shown Fig.4, ensure that the mounting holds on the PC board match the pitch of the leads correctly-tolerance of dimensions of the respective components including the LED should be taken into account especially when designing the case, PC board, etc. to prevent pitch misalignment between the leads and board holes, the diameter of the board holes should be slightly larger than the size of the lead. Alternatively, the shape of the holes should be made oval. (See Fig.4)

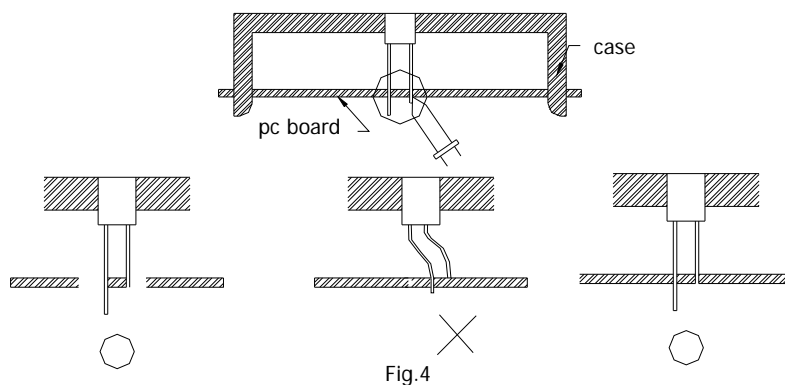

4) Use LEDs with stand-off (Fig.5) or the tube or spacer made of resin (Fig.6) to position the LEDs.

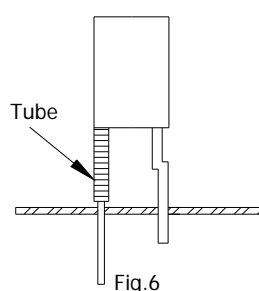
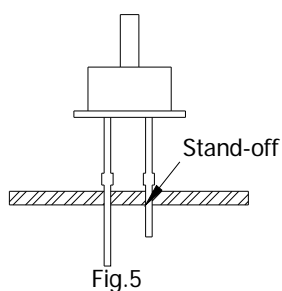

•FORMED LEAD

- 1) The lead should be bent at a point located at least 2mm away from the package. Bending should be performed with base fixed means of a jig or pliers (Fig.7)

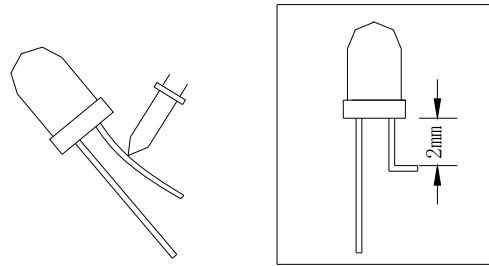

Fig. 7

- 2) Forming lead should be carried out prior to soldering and never during or after soldering.
- 3) Form the lead to ensure alignment between the leads and the hole on board, so that stress against the LED is prevented. (Fig.8)

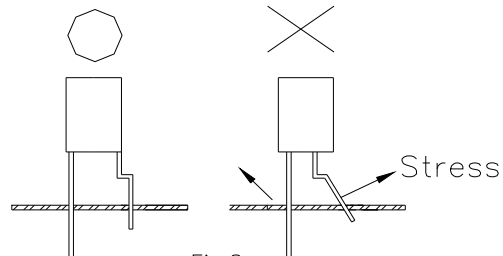

Fig.8

•LEAD STRENGTH

- 1) Bend strength
Do not bend the lead more than twice. (Fig.9)

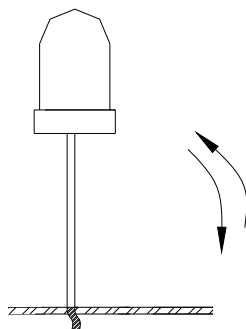

Fig.9



3.0mm LED LAMP WITH H308 HOLDER

LH322006B

REV:A / 0

2) Tensile strength (@Room Temperature)

If the force is 1kg or less, there will be no problem. (Fig.10)



• HEAT GENERATION

- 1) Thermal design of the end product is of paramount importance. Please consider the heat generation of the LED when making the system design. The coefficient of temperature increase per input electric power is affected by the thermal resistance of the circuit board and density of LED placement on the board, as well as other components. It is necessary to avoid intense heat generation and operate within the maximum ratings given in this specification.

The operating current should be decided after considering the ambient maximum temperature of LEDs.

•CHEMICAL RESISTANCE

- 1) Avoid exposure to chemicals as it may attack the LED surface and cause discoloration.
- 2) When washing is required, refer to the following table for the proper chemical to be used. (Immersion time: within 3 minutes at room temperature.)

SOLVENT	ADAPTABILITY
Freon TE	⊙
Chloroethene	×
Isopropyl Alcohol	⊙
Thinner	×
Acetone	×
Trichloroethylene	×

⊙--Usable ×--Do not use.

NOTE: Influences of ultrasonic cleaning of the LED resin body differ depending on such factors as the oscillator output, size of the PC board and the way in which the LED is mounted. Therefore, ultrasonic cleaning should only be performed after confirming there is no problem by conducting a test under practical.



3.0mm LED LAMP WITH H308 HOLDER

LH322006B

REV:A / 0

•OTHERS

- 1) Care must be taken to ensure that the reverse voltage will not exceed the absolute maximum rating when using the LEDs with matrix drive.
- 2) Flashing lights have been known to cause discomfort in people; you can prevent this by taking precautions during use. Also, people should be cautious when using equipment that has had LEDs incorporated into it.
- 3) The LEDs described in this brochure are intended to be used for ordinary electronic equipment (such as office equipment, communications equipment, measurement instruments and household appliances). Consult PARA's sales staff in advance for information on the applications in which exceptional quality and reliability are required , particularly when the failure or malfunction of the LEDs may directly jeopardize life or health (such as for airplanes, aerospace, submersible repeaters, nuclear reactor control systems, automobiles, traffic control equipment, life support systems and safety devices).
- 4) User shall not reverse engineer by disassembling or analysis of the LEDs without having prior written consent from PARA. When defective LEDs are found, the User shall inform PARA directly before disassembling or analysis.
- 5) The formal specifications must be exchanged and signed by both parties before large volume purchase begins.
- 6) The appearance and specifications of the product may be modified for improvement without notice.



3.0mm LED LAMP WITH H308 HOLDER

LH322006B

REV:A / 0

L - H 3 1 1 0 0 5 B

LENGTH

- A: 2.75mm
- B: 3.00mm
- C: 3.20mm
- D: 3.30mm
- E: 3.50mm
- F: 4.00mm
- G: 5.00mm
- H: 18.05mm

Series number

HOLDERS Type

- 1: 1PCS
- 2: 2PCS
- 3: 3PCS
- 4: 4PCS
- 5: 5PCS

- 3: 3mmLAMPS
- 4: 4mmLAMPS
- 5: 5mmLAMPS



3.0mm LED LAMP WITH H308 HOLDER

LH322006B

REV:A / 0

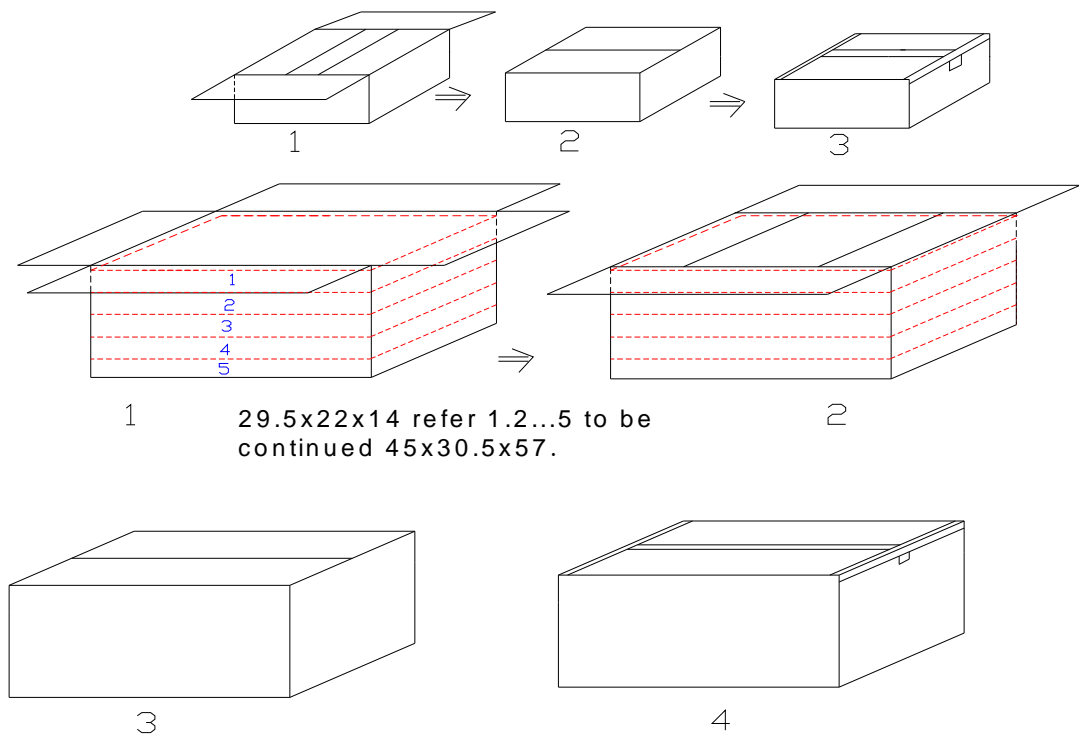
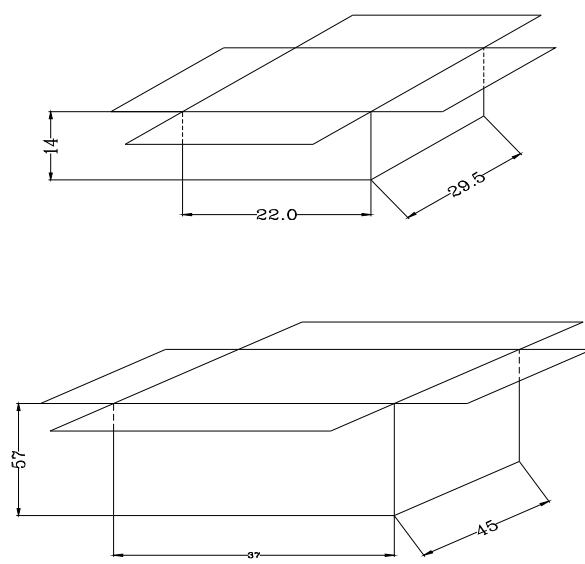

LH322006B package rule Note:

- 1、 29.5x22x14 presents little package box ,14little bags in every 29.5x22x14,0.5K in every bag.
- 2、 45x30.5x57 presents big package box, five little 29.5x22x14 boxes in every 45x30.5x57,total 35K in every 45x30.5x57.
- 3、 Specific package course refers to the attached graph.