



PARA LIGHT ELECTRONICS CO., LTD.

4F, No.1, Lane 93, Chien Yi Road, Chung Ho City, Taipei, Taiwan,

Tel: 886-2-2225-3733

Fax: 886-2-2225-4800

E-mail: para@para.com.tw

<http://www.para.com.tw>

DATA SHEET

PART NO.: L-S115KRKGCT-5A

REV: A / 0

CUSTOMER'S APPROVAL : _____

DCC : _____

DRAWING NO. : DS-78-08-0001

DATE : 2008-01-14

PAGE

1 of 15



SURFACE MOUNT DEVICE LED

Part No. : L-S115KRKGCT-5A

REV: A / 0

● PACKAGE OUTLINE DIMENSIONS

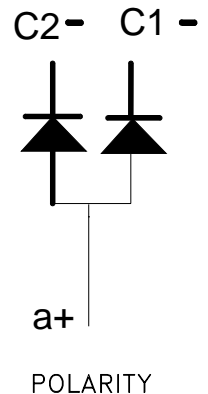
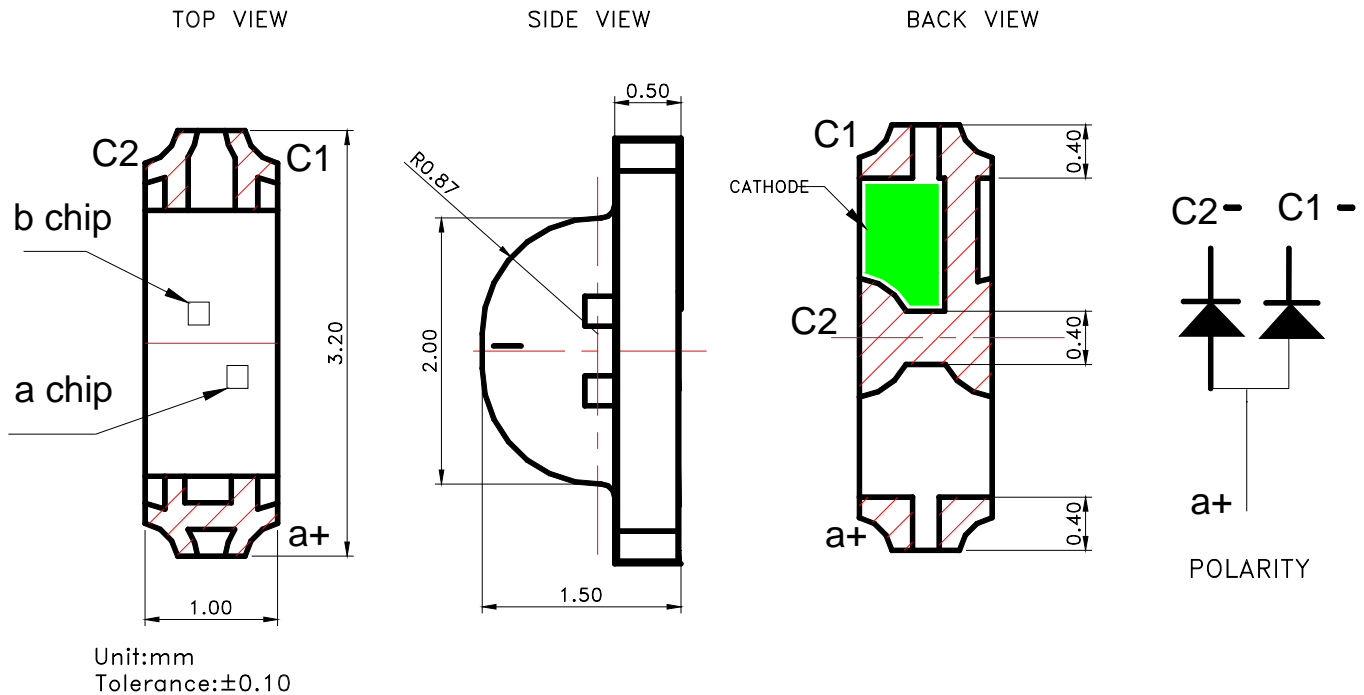

Notes:

1. a chip: Super Red; b chip: Yellow Green.
2. All dimensions are in millimeters.
3. Tolerance is $\pm 0.1\text{mm}$ (.004") unless otherwise noted.

● Features

- * Dual color, common anode, side view Chip LED.
- * Package in 8mm tape on 7" diameter reels.
- * Compatible with automatic Pick & Place equipment.
- * Compatible with Reflow soldering and Wave soldering processes.
- * EIA STD package.
- * I.C. compatible.
- * Pb free product.
- * Meet RoHS Green Product.



SURFACE MOUNT DEVICE LED

Part No. : L-S115KRKGCT-5A

REV: A / 0

● Chip Materials

chip	Light Color	Dice Material	Lens Color
a	KR: Super Red	AlInGaP	Water Clear
b	KG: Yellow Green		

● Absolute Maximum Ratings(Ta=25)

Symbol	Parameter	Rating		Unit
		Super Red	Yellow Green	
P _D	Power Dissipation	75	60	mW
I _{PF}	Peak Forward Current (1/10 Duty Cycle, 0.1ms Pulse Width)	80	60	mA
I _F	Continuous Forward Current	30	30	mA
-	De-rating Linear From 25	0.25	0.25	mA/
V _R	Reverse Voltage	5	5	V
ESD	Electrostatic Discharge Threshold(HBM) ^{Note A}	2000		V
T _{opr}	Operating Temperature Range	-40 ~ +85		
T _{stg}	Storage Temperature Range	-40 ~ +85		

Note A:

HBM: Human Body Model. Seller gives no other assurances regarding the ability of to withstand ESD

● Electro-Optical Characteristics(Ta=25)

Parameter	Symbol	Super Red	Yellow Green	Unit	Test Condition
Luminous Intensity	Min.	6.3	4.0	mcd	IF=5mA
	Typ.	20	10		
Viewing Angle	Typ.	2 1/2 130		deg	Note 2
Peak Wavelength	Typ.	p 637	571	nm	Measurement @Peak
Dominant Wavelength	Typ.	d 630	570	nm	IF=5mA
Spectral Line Half-Width	Typ.	17	15	nm	
Forward Voltage	Typ.	1.8	1.95	V	IF =5mA
	Max.	2.3	2.3		
Reverse Current	Max.	IR 100		μ A	VR = 5V



SURFACE MOUNT DEVICE LED

Part No. : L-S115KRKGCT-5A

REV: A / 0

● Bin Code List

Luminous Intensity(IV), Unit:mcd@5mA					
Super Red(a chip)			Yellow Green(b chip)		
Bin Code	Min	Max	Bin Code	Min	Max
K	7.1	11.2	J	4.5	7.1
L	11.2	18	K	7.1	11.2
M	18.0	28.0	L	11.2	18
N	28.0	45.0	M	18.0	28.0

Tolerance of each bin are $\pm 15\%$

Dominant Wavelength (Hue),Unit: nm@5mA		
Yellow Green(b chip)		
Bin Code	Min	Max
GA	567.0	570.0
GB	570.0	573.0
GC	573.0	576.0

Tolerance of each bin are $\pm 1\text{nm}$

Notes:

1. Luminous intensity is measured with a light sensor and filter combination that proximities the CIE eye-response curve.
2. 1/2 is the off-axis angle at which the luminous intensity is half the axial luminous intensity.
3. The dominant wavelength d is derived from the CIE chromaticity diagram and represents the single wavelength which defines the color of the device.
4. Caution in ESD :
Static Electricity and surge damages the LED. It is recommended use a wrist band or anti-electrostatic glove when handling the LED. All devices, equipment and machinery must be properly grounded.
5. Major standard testing equipment by “Instrument System” Model : CAS140B Compact Array Spectrometer and “KEITHLEY” Source Meter Model : 2400.



SURFACE MOUNT DEVICE LED

Part No. : L-S115KRKGCT-5A

REV: A / 0

● Super Red Typical Electro-Optical Characteristics Curves

(25 Ambient Temperature Unless Otherwise Noted)

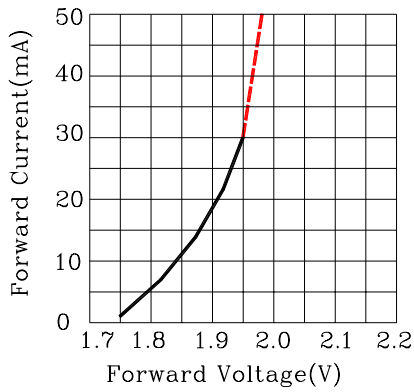

Fig.2 Forward Current vs. Forward Voltage

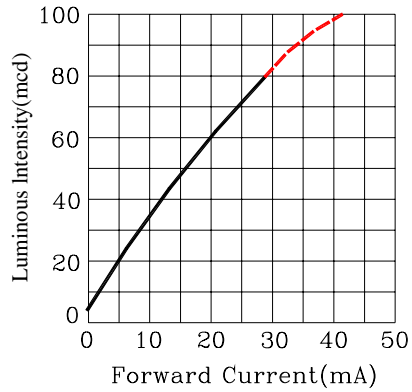

Fig.3 Luminous Intensity vs. Forward Current

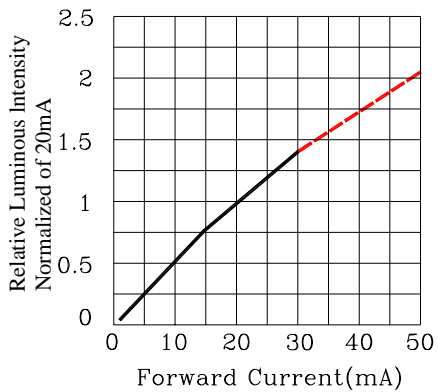

Fig.4 Relative Luminous Intensity vs. Forward Current

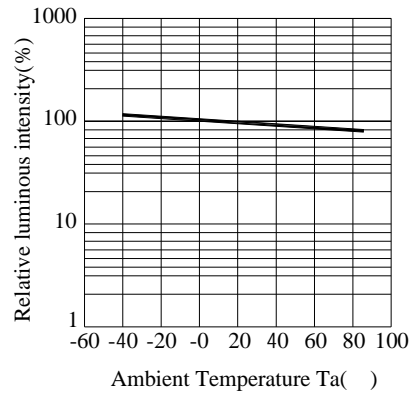

Fig.5 Luminous Intensity vs. Ambient Temperature

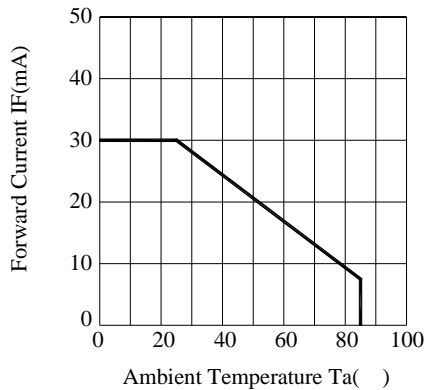

Fig.6 Forward Current Derating Curve

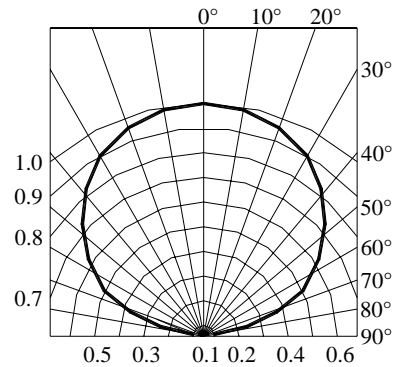

Fig.7 Relative Intensity vs. Angle



SURFACE MOUNT DEVICE LED

Part No. : L-S115KRKGCT-5A

REV: A / 0

● Yellow Green Typical Electro-Optical Characteristics Curves

(25 Ambient Temperature Unless Otherwise Noted)

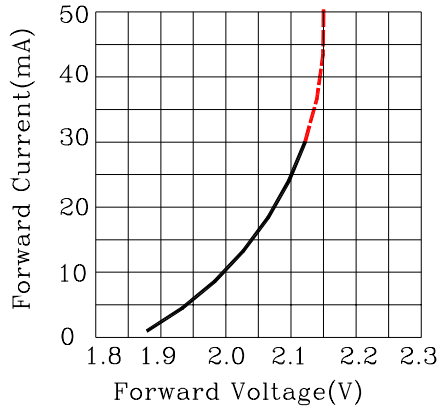

Fig.2 Forward Current vs. Forward Voltage

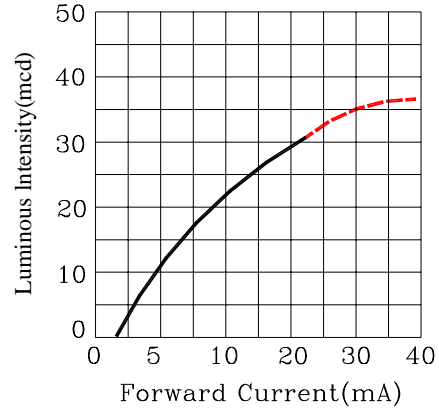

Fig.3 Luminous Intensity vs. Forward Current

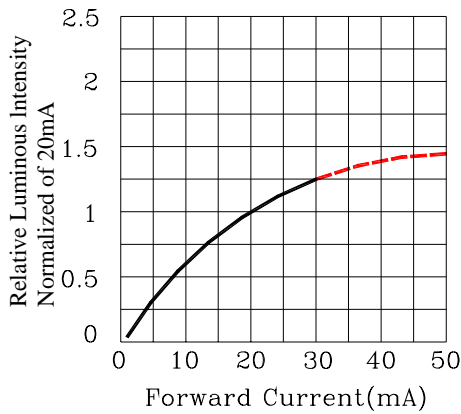

Fig.4 Relative Luminous Intensity vs. Forward Current

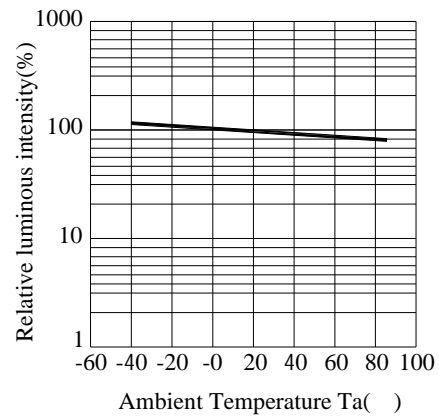

Fig.5 Luminous Intensity vs. Ambient Temperature

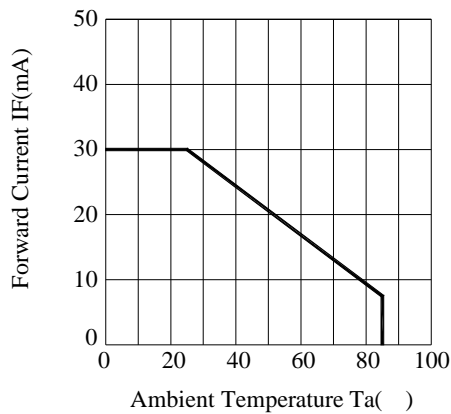

Fig.6 Forward Current Derating Curve

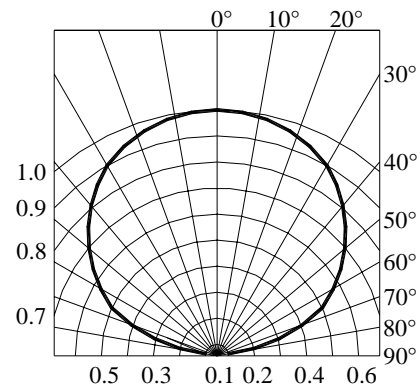

Fig.7 Relative Intensity vs. Angle



SURFACE MOUNT DEVICE LED

Part No. : L-S115KRKGCT-5A

REV: A / 0

● Label Explanation



CUS. PART NO: To be denominated.

CUSTOMER: To be denominated.

PART NO: Refer to P15

IV --- Luminous Intensity Code

VF --- Forward Voltage Code

WD --- Dominant Wavelength Code

LOT NO: E L S 6 8 0001
 A B C D E F

A---E: For series number

B---L: Local F: Foreign

C---S:SMD

D---Year

E---Month

F---SPEC.

PACKING QUANTITY OF BAG :

3000pcs for 150、170、110、155、115 series

4000pcs for 191 series

5000pcs for 192 series

DATE CODE : 2006 06 08
 G H I

G--- Year

H--- Month

I --- Day



SURFACE MOUNT DEVICE LED

Part No. : L-S115KRKGCT-5A

REV: A / 0

● Typical Electro-Optical Characteristics Curves

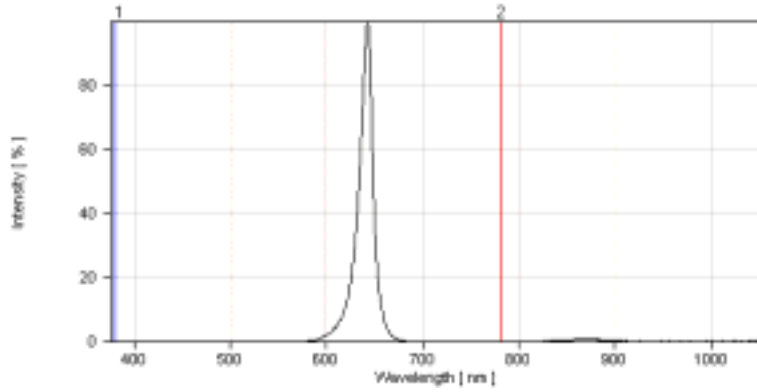

Fig.1 Super Red Relative Intensity vs. Wavelength

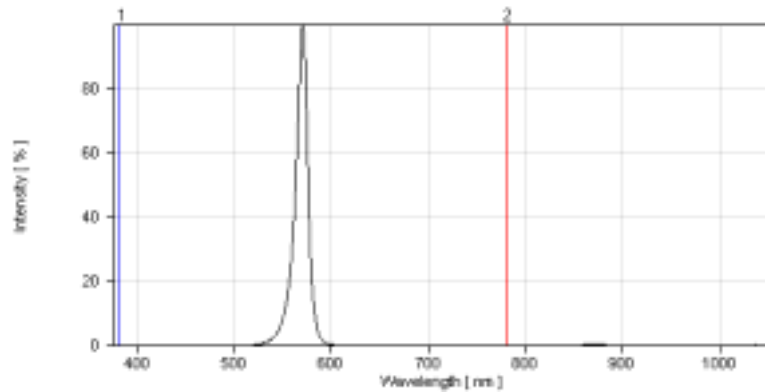
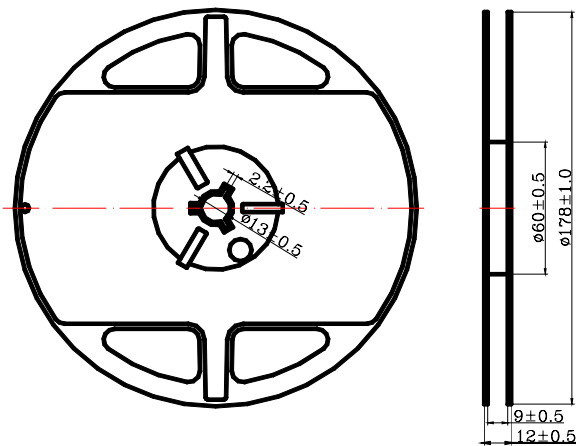

Fig.2 Yellow Green Relative Intensity vs. Wavelength

● Reel Dimensions



Notes:

1. Taping Quantity : 3000pcs.
2. The tolerances unless mentioned is ± 0.1 mm, Angle $\pm 0.5^\circ$, Unit : mm.



SURFACE MOUNT DEVICE LED

Part No. : L-S115KRKGCT-5A

REV: A / 0

● Package Dimensions Of Tape And Reel

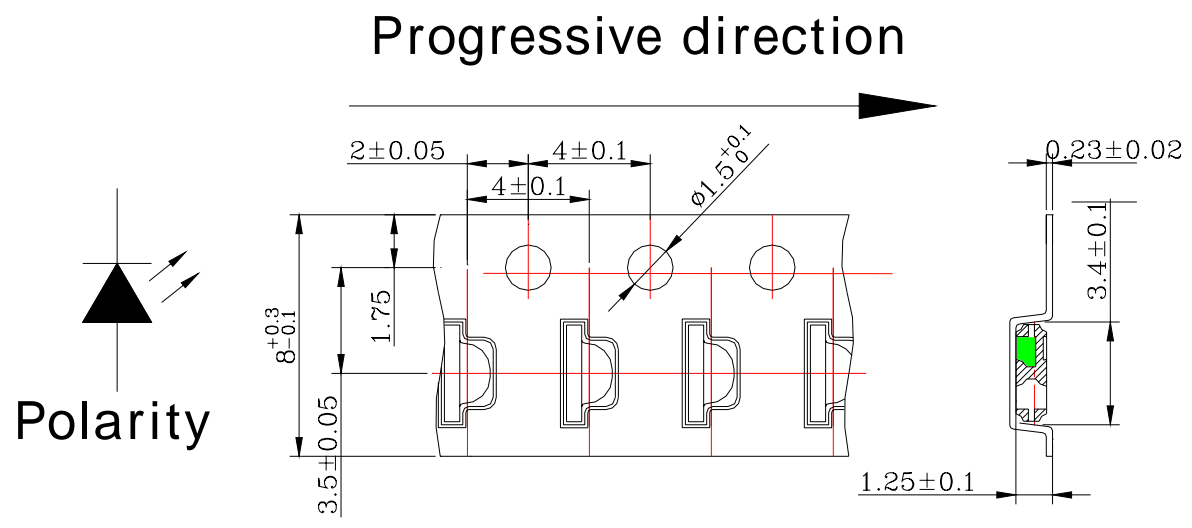

Notes : All dimensions are in millimeters.

Moisture Resistant Packaging

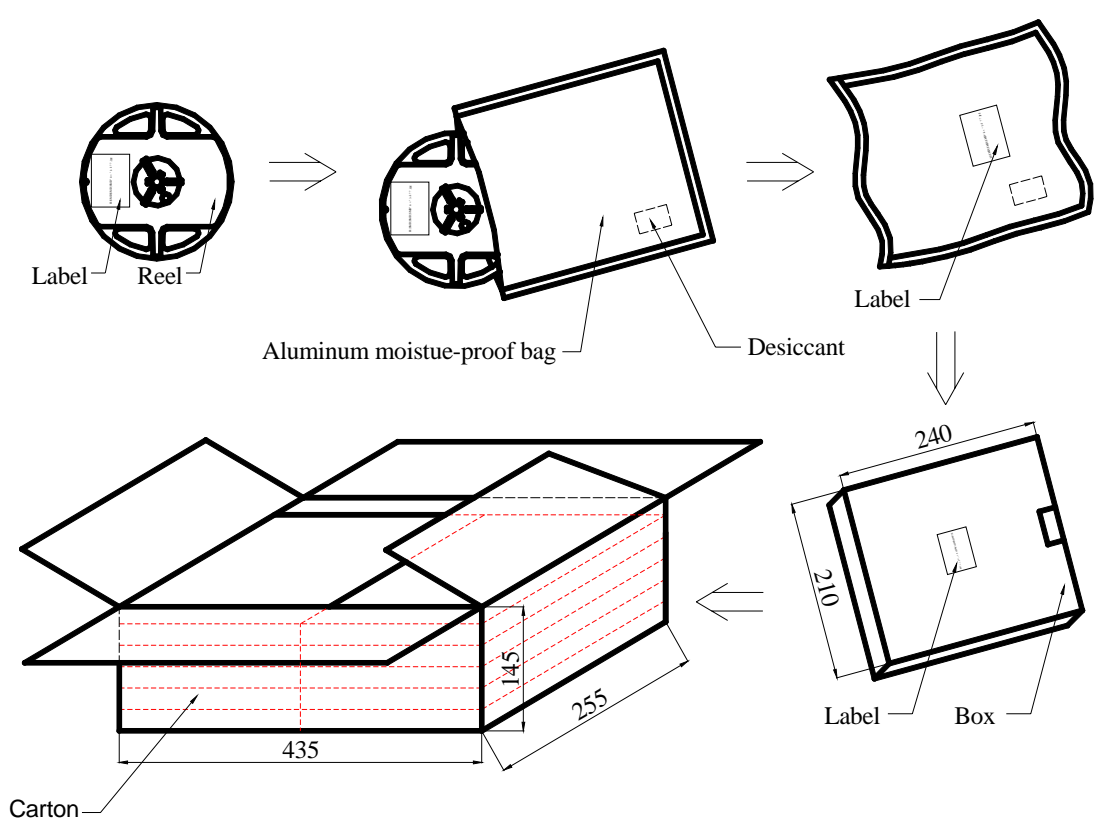

Notes : One reel in a bag, one bag in a inner box, ten inner boxes in a carton. Unit : mm.



SURFACE MOUNT DEVICE LED

Part No. : L-S115KRKGCT-5A

REV: A / 0

● Cleaning

- * If cleaning is required , use the following solutions for less than 1 minute and less than 40 .
- * Appropriate chemicals: Ethyl alcohol and isopropyl alcohol.
- * Effect of ultrasonic cleaning on the LED resin body differs depending on such factors as the oscillator output, size of PCB and LED mounting method. The use of ultrasonic cleaning should be enforced at proper output after confirming there is no problem.

● Suggest Soldering Pad Dimensions

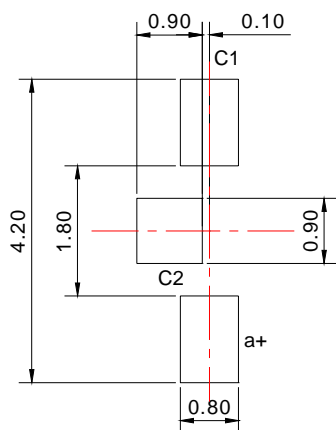

Direction of PWB camber
and go to reflow furnace



SURFACE MOUNT DEVICE LED

Part No. : L-S115KRKGCT-5A

REV: A / 0

Suggest Sn/Pb IR Reflow Soldering Profile Condition:

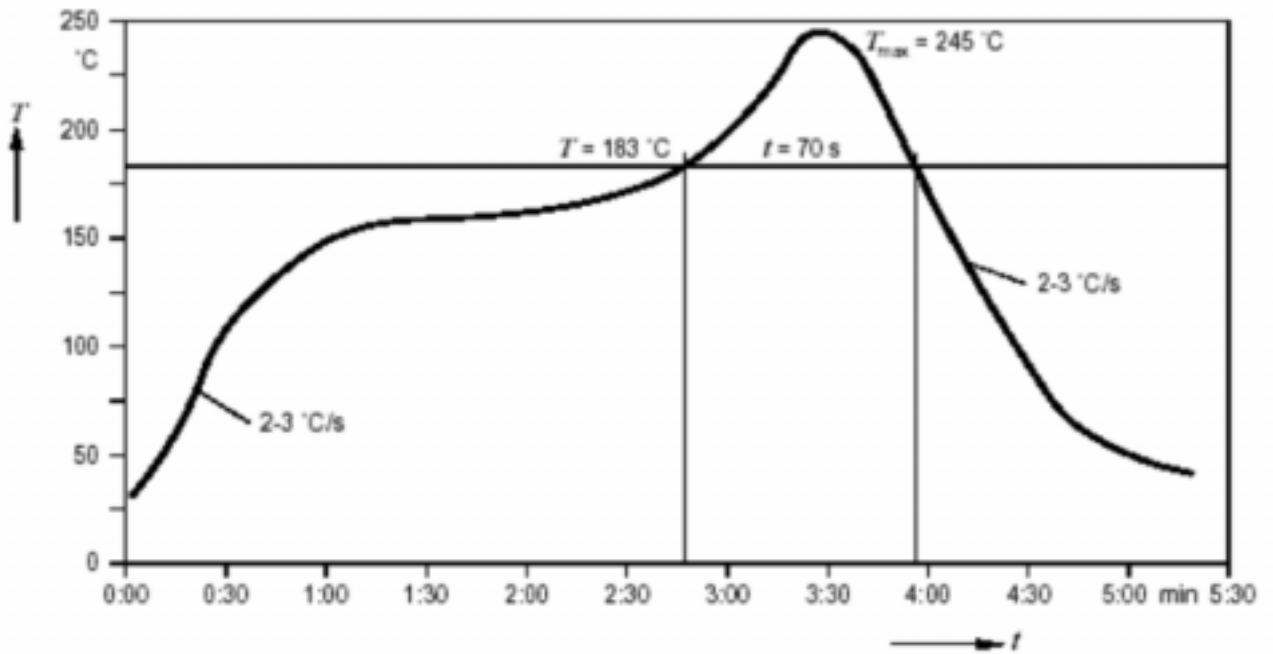

Suggest Pb-Free IR Reflow Soldering Profile Condition:

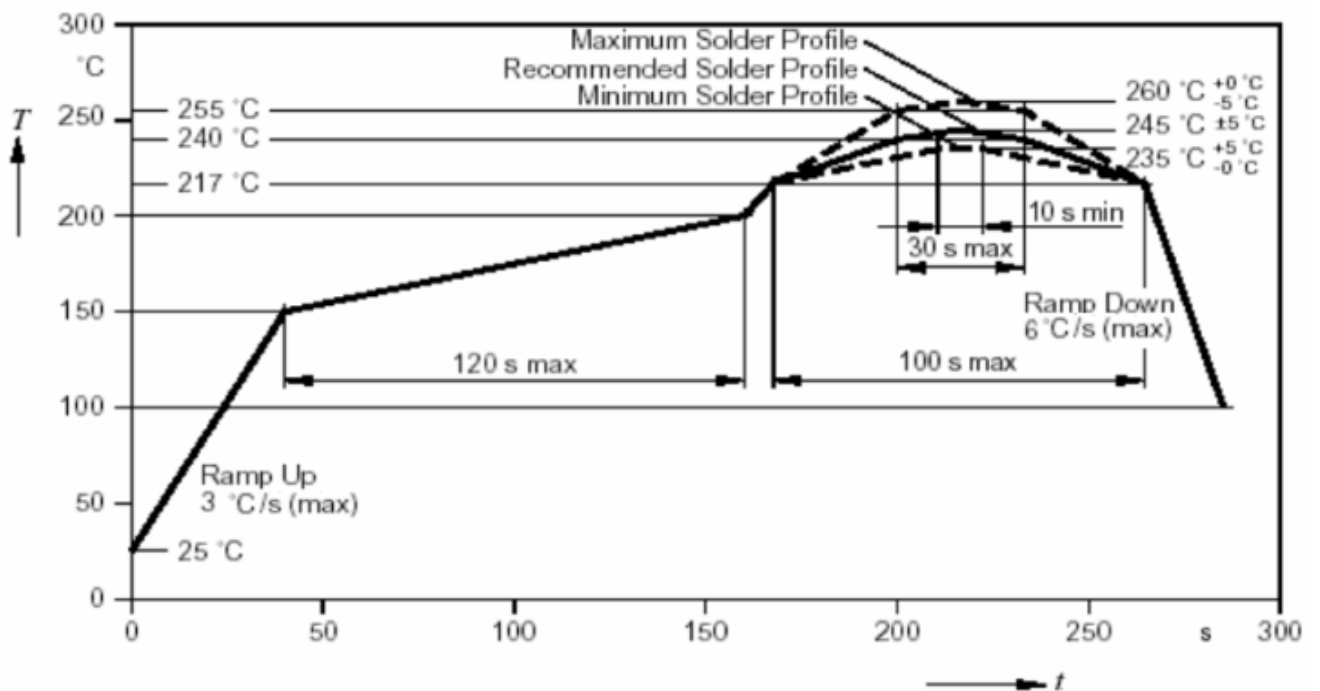



SURFACE MOUNT DEVICE LED

Part No. : L-S115KRKGCT-5A

REV: A / 0

● CAUTIONS

1.Application Limitation :

The LED's described here are intended to be used for ordinary electronic equipment (such as office equipment, communication equipment and household application). Consult PARA's sales in advance for information on application in which exceptional quality and reliability are required, particularly when the failure or malfunction of the LED's may directly jeopardize life or health (such as airplanes, automobiles, traffic control equipment, life support system and safety devices).

2.Storage :

Before opening the package :

The LEDs should be kept at 5°C to 30°C or less and 85%RH or less. The LEDs should be used within a year.

After opening the package :

The LEDs should be kept at 5°C to 30°C or less and 70%RH or less. The LEDs should be soldered within 168 hours(7 days) after opening the package.

Please avoid rapid transitions in ambient temperature in high humidity environments where condensation may occur.



SURFACE MOUNT DEVICE LED

Part No. : L-S115KRKGCT-5A

REV: A / 0

3. Soldering (Standard Process) :

Do not apply any stress to the lead frame during soldering while the LED is at high temperature.

Recommended soldering condition.

Reflow Soldering :

Pre-heat 120~150°C, 120sec. MAX., Peak temperature : 240°C Max. Soldering time : 10 sec Max.

Soldering Iron : (Not recommended)

Temperature 300°C Max., Soldering time : 3 sec. Max. (one time only), power dissipation of iron : 20W Max. use SN60 solder of solder with silver content and don't touch LED lens when soldering.

Wave soldering :

Pre-heat 100°C Max, Pre-heat time 60s Max, Solder wave 260°C Max, Soldering time 5 sec. Max.

performed consecutively cooling process is required between 1st and 2nd soldering processes.

4. Lead-Free Soldering

For Reflow Soldering :

- 1、 Pre-Heat Temp : 150-180 , 120sec. Max.
- 2、 Soldering Temp : Temperature Of Soldering Pot Over 230 , 40sec. Max.
- 3、 Peak Temperature : 260 , 5sec.
- 4、 Reflow Repetition : 2 Times Max.
- 5、 Suggest Solder Paste Formula 93.3 Sn/3.1 Ag/3.1 Bi /0.5 Cu

For Soldering Iron (Not Recommended) :

- 1、 Iron Tip Temp : 350 Max.
- 2、 Soldering Iron : 30w Max.
- 3、 Soldering Time : 3 Sec. Max. One Time.

For Dip Soldering :

- 1、 Pre-Heat Temp : 150 Max. 120 Sec. Max.
- 2、 Bath Temp : 265 Max.
- 3、 Dip Time : 5 Sec. Max.

5. Drive Method

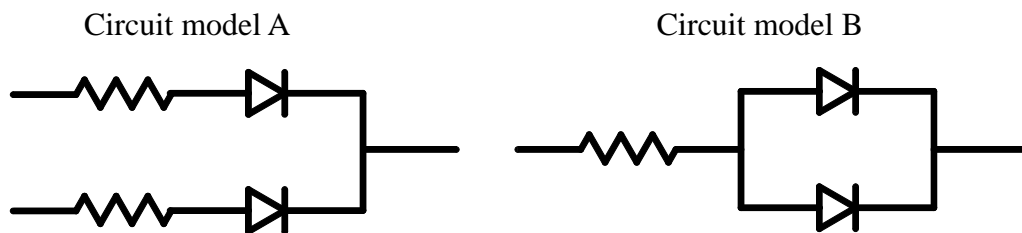

(A) Recommended circuit.

(B) The difference of brightness between LED's could be found due to the Vf-If characteristics of LED.

	<h2 style="margin: 0;">SURFACE MOUNT DEVICE LED</h2>
	<p style="margin: 0;">Part No. : L-S115KRKGCT-5A REV: A / 0</p>

6. Reliability Test

Classification	Test Item	Test Condition	Reference Standard
Endurance Test	Operation Life	Ta= Under Room Temperature As Per Data Sheet Maximum Rating *Test Time= 1000HRS (-24HRS,+72HRS)*@20mA.	MIL-STD-750D:1026 (1995) MIL-STD-883D:1005 (1991) JIS C 7021:B-1 (1982)
	High Temperature High Humidity Storage	IR-Reflow In-Board, 2 Times Ta= 65±5 ,RH= 90 ~ 95% *Test Time= 1000HRS±2HRS	MIL-STD-202F:103B(1980) JIS C 7021:B-11(1982)
	High Temperature Storage	Ta= 105±5 Test Time= 1000HRS (-24HRS,72HRS)	MIL-STD-883D:1008 (1991) JIS C 7021:B-10 (1982)
	Low Temperature Storage	Ta= -55±5 *Test Time=1000HRS (-24HRS,72H RS)	JIS C 7021:B-12 (1982)
Environmental Test	Temperature Cycling	105±5 -55±5 10mins 10mins 100 Cycles	MIL-STD-202F:107D (1980) MIL-STD-750D:1051(1995) MIL-STD-883D:1010 (1991) JIS C 7021:A-4(1982)
	Thermal Shock	IR-Reflow In-Board, 2 Times 105±5 -55 ±5 10mins 10mins 100 Cycles	MIL-STD-202F:107D(1980) MIL-STD-750D:1051(1995) MIL-STD-883D:1011 (1991)
	Solder Resistance	Tsol= 260 ± 5 Dwell Time= 10 ± 1sec	MIL-STD-202F:210A(1980) MIL-STD-750D:2031(1995) JIS C 7021:A-1(1982)
	Solder ability	Tsol= 235 ± 5 Immersion time 2±0.5 sec Immersion rate 25±2.5 mm/sec Coverage 95% of the dipped surface	MIL-STD-202F:208D(1980) MIL-STD-750D:2026(1995) MIL-STD-883D:2003(1991) IEC 68 Part 2-20 JIS C 7021:A-2(1982)

7. Others:

The appearance and specifications of the product may be modified for improvement without notice.



SURFACE MOUNT DEVICE LED

Part No. : L-S115KRKGCT-5A

REV: A / 0

● PART NO. SYSTEM :

L - S 115X1X2 X X - X X X X

XXXX : Special specification for customer

T : Taping for 7 inch reel

TC : Taping for 13 inch reel

TH : IV half binning

TP : Wavelength binning

Lens color

C : Water Clear

W : White Diffused

T : Color Transparent

D : Color Diffused

G : Gap 570nm Green

Y : GaAsp 585 nm Yellow

E : GaAsp 620 nm Orange

SR : GaAlAs 634 nm Red

KG : AllnGap 570nm Super Green

KY : AllnGap 590nm Super Yellow

KF : AllnGap 605nm Super Amber

KR : AllnGap 630 nm Super Red

KD : AllnGap 639 nm Deep Red

LB : InGaN 470nm Blue

LG : InGaN 525nm Green

0 : Single chip

1 / 2 : Super thin single chip

5 / 6 : Dual chip

F : Three chip(Full color)

150 : 1206 1.1T Type

155 : 1210 1.1T Type

170 : 0805 0.8T Type

191 : 0603 0.6T Type

192 : 0603 0.4T Type

195 : 0603 0.6T Type

110 : 1206 1.0T Type

115 : 1206 1.0T Type

C : Top View Type

S : Side View Type