

## Silicon Epitaxial Planar Transistor

## S9018

### FEATURES

- High current gain bandwidth product.
- power dissipation.( $P_C=200\text{mW}$ )



Lead-free

### APPLICATIONS

- NPN epitaxial silicon transistor.

### ORDERING INFORMATION

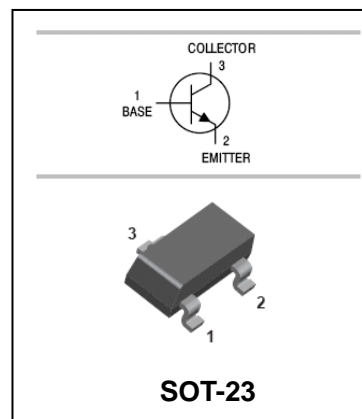

Type No.	Marking	Package Code
S9018	J8	SOT-23

### MAXIMUM RATING @ $T_a=25^\circ\text{C}$ unless otherwise specified

Symbol	Parameter	Value	Units
$V_{CB0}$	Collector-Base Voltage	25	V
$V_{CEO}$	Collector-Emitter Voltage	18	V
$V_{EBO}$	Emitter-Base Voltage	4	V
$I_C$	Collector Current -Continuous	50	mA
$P_C$	Collector Dissipation	200	mW
$T_j, T_{stg}$	Junction and Storage Temperature	-55~150	$^\circ\text{C}$

### ELECTRICAL CHARACTERISTICS @ $T_a=25^\circ\text{C}$ unless otherwise specified

Parameter	Symbol	Test conditions	MIN	TYP	MAX	UNIT
Collector-base breakdown voltage	$V_{(BR)CB0}$	$I_C=100\mu\text{A}, I_E=0$	25			V
Collector-emitter breakdown voltage	$V_{(BR)CEO}$	$I_C=0.1\text{mA}, I_B=0$	18			V
Emitter-base breakdown voltage	$V_{(BR)EBO}$	$I_E=-100\mu\text{A}, I_C=0$	4			V
Collector cut-off current	$I_{CB0}$	$V_{CB}=20\text{V}, I_E=0$			0.1	$\mu\text{A}$
Collector cut-off current	$I_{CEO}$	$V_{CE}=15\text{V}, I_B=0$			0.1	$\mu\text{A}$
Emitter cut-off current	$I_{EBO}$	$V_{EB}=3\text{V}, I_C=0$			0.1	$\mu\text{A}$
DC current gain	$h_{FE}$	$V_{CE}=5\text{V}, I_C=1\text{mA}$	70		190	
Collector-emitter saturation voltage	$V_{CE(sat)}$	$I_C=10\text{mA}, I_B=1\text{mA}$			0.5	V
Base-emitter saturation voltage	$V_{BE(sat)}$	$I_C=10\text{mA}, I_B=1\text{mA}$			1.4	V
Transition frequency	$f_T$	$V_{CE}=5\text{V}, I_C=5\text{mA}$ $f=400\text{MHz}$	600			MHz

## Silicon Epitaxial Planar Transistor

# S9018

TYPICAL CHARACTERISTICS @ Ta=25°C unless otherwise specified

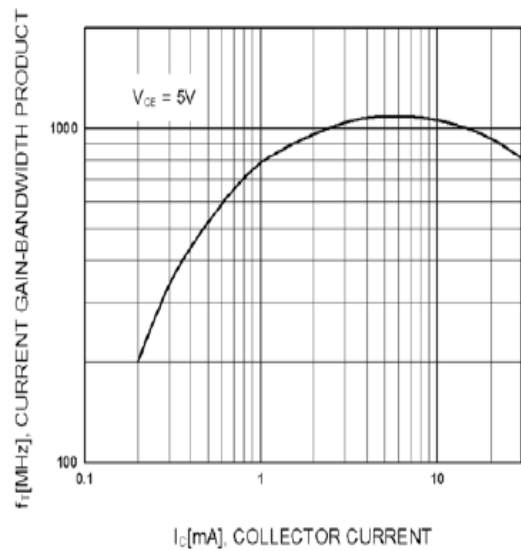
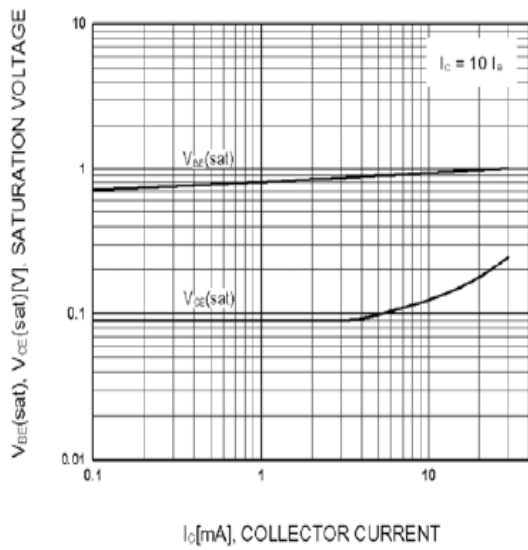
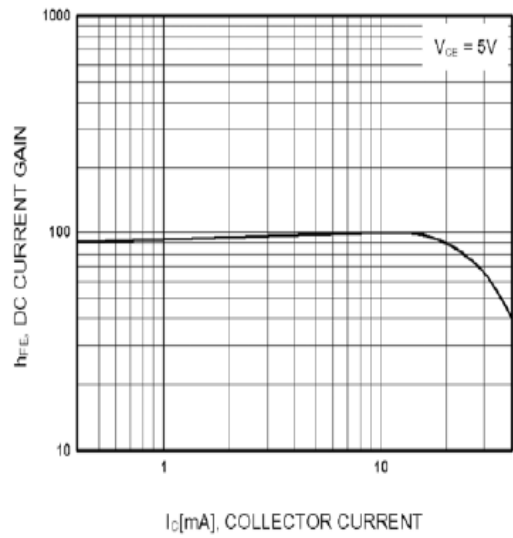
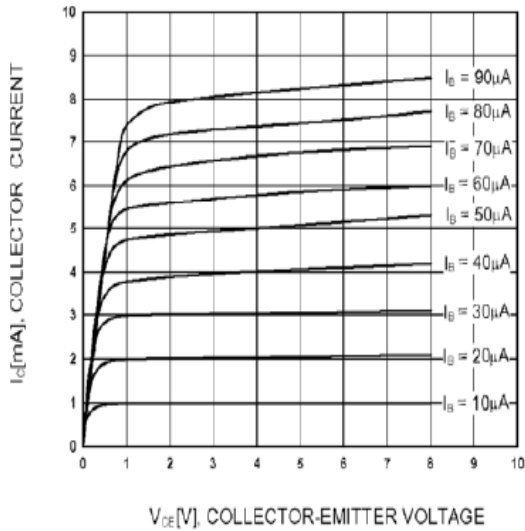

## Silicon Epitaxial Planar Transistor

## S9018

### PACKAGE OUTLINE

Plastic surface mounted package

SOT-23

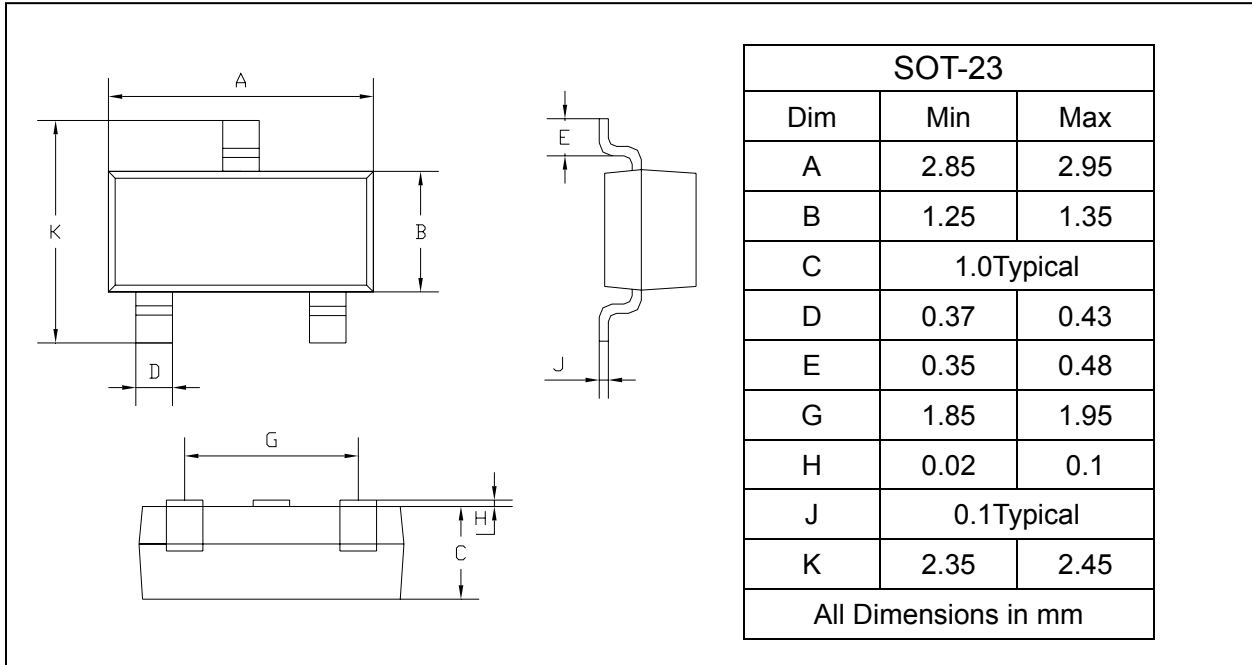

### SOLDERING FOOTPRINT

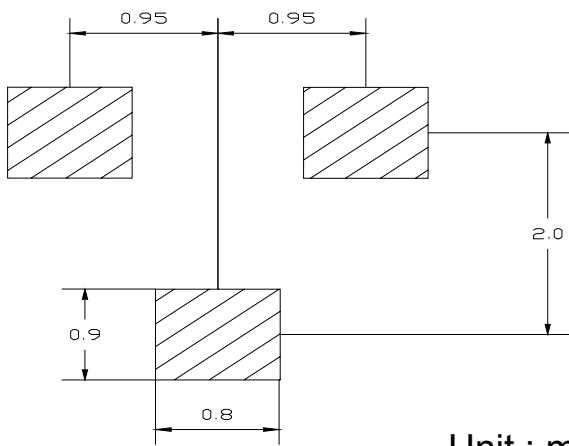

Unit : mm

### PACKAGE INFORMATION

Device	Package	Shipping
S9018	SOT-23	3000/Tape&Reel