

User Guide for Nokia 7270



9231145
Issue 1

DECLARATION OF CONFORMITY

We, NOKIA CORPORATION declare under our sole responsibility that the product RM-8 is in conformity with the provisions of the following Council Directive: 1999/5/EC.

A copy of the Declaration of Conformity can be found from http://www.nokia.com/phones/declaration_of_conformity/.

CE 168

Copyright © 2004 Nokia. All rights reserved.

Reproduction, transfer, distribution or storage of part or all of the contents in this document in any form without the prior written permission of Nokia is prohibited.

Nokia, Nokia Connecting People, and Pop-Port are trademarks or registered trademarks of Nokia Corporation. Other product and company names mentioned herein may be trademarks or tradenames of their respective owners.

Nokia tune is a sound mark of Nokia Corporation.

US Patent No 5818437 and other pending patents. T9 text input software Copyright (C) 1997-2004. Tegic Communications, Inc. All rights reserved.



Includes RSA BSAFE cryptographic or security protocol software from RSA Security.



Java
POWERED
Java is a trademark of Sun Microsystems, Inc.

USE OF THIS PRODUCT IN ANY MANNER THAT COMPLIES WITH THE MPEG-4 VISUAL STANDARD IS PROHIBITED, EXCEPT FOR USE DIRECTLY RELATED TO (A) DATA OR INFORMATION (i) GENERATED BY AND OBTAINED WITHOUT CHARGE FROM A CONSUMER NOT THEREBY ENGAGED IN A BUSINESS ENTERPRISE, AND (ii) FOR PERSONAL USE ONLY; AND (B) OTHER USES SPECIFICALLY AND SEPARATELY LICENSED BY MPEG LA, L.L.C.

Nokia operates a policy of continuous development. Nokia reserves the right to make changes and improvements to any of the products described in this document without prior notice.

Under no circumstances shall Nokia be responsible for any loss of data or income or any special, incidental, consequential or indirect damages howsoever caused.

The contents of this document are provided "as is". Except as required by applicable law, no warranties of any kind, either express or implied, including, but not limited to, the implied warranties of merchantability and fitness for a particular purpose, are made in relation to the accuracy, reliability or contents of this document. Nokia reserves the right to revise this document or withdraw it at any time without prior notice.

The availability of particular products may vary by region. Please check with the Nokia dealer nearest to you.

9231145 / Issue 1

Contents

FOR YOUR SAFETY	12
General information.....	16
Access codes	16
Configuration settings service.....	18
1. Getting started	19
Opening the fold.....	19
The wraps of the phone.....	20
Maintaining the textile wraps.....	20
Installing the battery and the SIM card.....	21
Attaching the wrist strap.....	23
Charging the battery	24
Switching the phone on and off.....	25
2. Your phone.....	27
Introduction to the phone - fold closed.....	27
Introduction to the phone - fold open.....	29
Standby mode.....	30
Mini display	30
Main display.....	31
Wallpaper.....	32
Screen saver	32
Essential indicators in standby mode	33
Some shortcuts in standby mode	35
Keypad lock (Keyguard)	36

3. Call functions	37
Making a call	37
Making a call using contacts.....	37
Speed dialing.....	37
Answering or rejecting a call	38
Options during a call	39
4. Writing text.....	41
Setting predictive text input on and off.....	41
Selecting the writing language	41
Using predictive text input.....	42
Writing compound words.....	42
Using traditional text input.....	43
Tips for writing text.....	43
5. Using the menu	45
Accessing a menu function	45
List of menu functions.....	47
6. Menu functions	52
Messages.....	52
Text messages (SMS).....	52
Writing and sending SMS messages.....	53
Options for sending a message.....	53
Reading and replying to an SMS message.....	54
Templates.....	54
Multimedia messages	55
Writing and sending a multimedia message	55
Reading and replying to a multimedia message	57
Multimedia messages memory full.....	59

Inbox, Outbox, Saved items and Sent items folders	59
Instant messages.....	60
Entering the instant messaging menu.....	61
Connecting to and disconnecting from the instant messaging service.....	62
Starting an instant messaging conversation	62
Accepting or rejecting an instant messaging invitation	64
Reading a received instant message.....	64
Participating in an instant messaging conversation	65
Editing your own settings	65
Contacts for instant messaging	66
Blocking and unblocking messages.....	66
Groups.....	67
E-mail messages.....	67
Writing and sending an e-mail.....	68
Downloading e-mail messages.....	69
Reading and replying to an e-mail message	70
Inbox and Other folders.....	70
Deleting e-mail messages	71
Voice messages.....	71
Info messages.....	71
Service commands.....	71
Deleting messages	72
Message settings.....	72
Settings for text messages.....	72
Settings for multimedia messages	73
Settings for e-mail application	75
Other settings	76
Message counter.....	76

Contacts	76
Searching for a contact.....	77
Saving names and phone numbers (Add contact).....	77
Saving multiple numbers or text items per name	77
Adding an image to a contact.....	79
Editing or deleting details in the contacts	79
Deleting contacts.....	80
Presence-enhanced contacts - My presence	80
Presence-enhanced contacts - Subscribed names.....	82
Adding contacts to the subscribed names	82
Viewing the subscribed names	83
Unsubscribing a contact.....	83
Copying contacts.....	83
Settings for contacts.....	84
Sending and receiving a business card	84
Voice dialing.....	85
Adding and managing voice tags.....	85
Making a call by using a voice tag.....	86
Other functions in the Contacts.....	86
Call register.....	87
Recent calls lists.....	87
Call counters and call timers.....	88
Message counter.....	88
Positioning	89
Settings	89
Profiles	89
Themes	90
Tone settings.....	90
Main display settings.....	91

Mini display settings.....	91
Time and date settings.....	92
Personal shortcuts.....	93
Connectivity.....	93
Infrared.....	93
GPRS.....	94
GPRS connection.....	95
GPRS modem settings.....	96
Call settings.....	96
Phone settings.....	98
Enhancement settings.....	99
Configuration settings.....	99
Security settings.....	101
Restore factory settings.....	102
Gallery.....	102
Media.....	104
Camera.....	104
Taking a photo.....	104
Recording a video clip.....	105
Camera settings.....	105
Media player.....	105
Setting up the phone for a streaming service.....	106
Radio.....	106
Tuning a radio channel.....	107
Using the loudspeaker.....	107
Voice recorder.....	108
Recording.....	108
Push to talk.....	109
Opening the push to talk menu.....	110

Connecting to and disconnecting from the push to talk service	110
Callback requests	111
Making and receiving a push to talk call	112
Making a group call	113
Making a one-to-one call	113
Receiving a group or a one-to-one call	114
Adding one-to-one contact	114
Creating and setting up groups	115
Settings for push to talk	117
Organiser	118
Alarm clock	118
When the alarm time expires	119
Calendar	120
Note alarm	121
To-do list	121
Notes	121
Synchronisation	122
Synchronising from your phone	123
Settings for synchronisation	123
Synchronising from a compatible PC	124
Wallet	124
Accessing the wallet menu	125
Saving card details	126
Personal notes	126
Creating a wallet profile	127
Wallet settings	127
Calculator	127
Performing a currency conversion	128
Stopwatch	128

Countdown timer.....	129
Applications	130
Games.....	130
Collection	130
Options available for an application.....	131
Downloading a game or an application.....	131
Web	132
Basic steps for accessing and using services	133
Setting up browsing.....	133
Connecting to a service.....	133
Browsing the pages.....	134
Browsing with phone keys.....	135
Options while browsing.....	135
Direct calling.....	136
Quit browsing.....	136
Appearance settings of the browser.....	136
Bookmarks.....	137
Receiving a bookmark	137
Downloading	138
Service inbox.....	138
Service inbox settings	138
The cache memory.....	139
Cookies.....	139
Scripts over secure connection	140
Browser security.....	140
Security module	140
Certificates	141
Digital signature	142
SIM services	143

7. PC Connectivity	144
Using data communication applications.....	144
8. Battery information.....	145
Charging and Discharging.....	145
9. Enhancements.....	147
CARE AND MAINTENANCE.....	148
ADDITIONAL SAFETY INFORMATION	150

FOR YOUR SAFETY

Read these simple guidelines. Not following them may be dangerous or illegal. Read the complete user guide for further information.



SWITCH ON SAFELY

Do not switch the phone on when wireless phone use is prohibited or when it may cause interference or danger.



ROAD SAFETY COMES FIRST

Obey all local laws. Always keep your hands free to operate the vehicle while driving. Your first consideration while driving should be road safety.



INTERFERENCE

All wireless phones may be susceptible to interference, which could affect performance.



SWITCH OFF IN HOSPITALS

Follow any restrictions. Switch the phone off near medical equipment.



SWITCH OFF IN AIRCRAFT

Follow any restrictions. Wireless devices can cause interference in aircraft.



SWITCH OFF WHEN REFUELLING

Don't use the phone at a refuelling point. Don't use near fuel or chemicals.



SWITCH OFF NEAR BLASTING

Follow any restrictions. Don't use the phone where blasting is in progress.



USE SENSIBLY

Use only in the normal position as explained in the product documentation. Don't touch the antenna unnecessarily.



QUALIFIED SERVICE

Only qualified personnel may install or repair this product.



ENHANCEMENTS AND BATTERIES

Use only approved enhancements and batteries. Do not connect incompatible products.



WATER-RESISTANCE

Your phone is not water-resistant. Keep it dry.



BACK-UP COPIES

Remember to make back-up copies or keep a written record of all important information stored in your phone.





CONNECTING TO OTHER DEVICES

When connecting to any other device, read its user guide for detailed safety instructions. Do not connect incompatible products.



EMERGENCY CALLS

Ensure the phone is switched on and in service. Press  as many times as needed to clear the display and return to the start screen. Key in the emergency number, then press the call key . Give your location. Do not end the call until given permission to do so.

■ ABOUT YOUR DEVICE

The wireless device described in this guide is approved for use on the EGSM900, GSM1800 and GSM1900 network. Contact your service provider for more information about networks.

When using the features in this device, obey all laws and respect privacy and legitimate rights of others.



Warning: To use any features in this device, other than the alarm clock, the device must be switched on. Do not switch the device on when wireless device use may cause interference or danger.

Your device and its enhancements may contain small parts. Keep them out of reach of small children.

For availability of approved enhancements, please check with your dealer. When you disconnect the power cord of any enhancement, grasp and pull the plug, not the cord.

■ Network Services

To use the phone you must have service from a wireless service provider. Many of the features in this device depend on features in the wireless network to function. These Network Services may not be available on all networks or you may have to make specific arrangements with your service provider before you can utilize Network Services. Your service provider may need to give you additional instructions for their use and explain what charges will apply. Some networks may have limitations that affect how you can use Network Services. For instance, some networks may not support all language-dependent characters and services.

Your service provider may have requested that certain features be disabled or not activated in your device. If so, they will not appear on your device menu. Contact your service provider for more information.

This device supports WAP 2.0 protocols (HTTP and SSL) that run on TCP/IP protocols. Some features of this device, such as multimedia messaging service (MMS), browsing, instant messaging, e-mail, presence-enhanced contacts, and remote synchronisation, content downloading using browser or MMS, require network support for these technologies.

■ SHARED MEMORY

The phone has three different memories. The following features in this device may share the first memory: contacts, text messages, instant messages and SMS e-mails, voice tags, calendar and notes. The second shared memory is used by multimedia messages, files stored in Gallery and configuration settings. The third shared memory is used by e-mail application, Java games and applications. Use of one or more of these features may reduce the memory available for the remaining features sharing the same memory. For example, saving many Gallery items may use all of the available memory in the second memory. Your device may display a message that the memory is full when you try to use a shared memory feature. In this case, delete some of the information or entries stored in the corresponding shared memory before continuing.

■ Nokia support on the Web

Check <www.nokia.com/support> or your local Nokia Web site for the latest version of this guide, additional information, downloads, and services related to your Nokia product.

General information

■ Access codes

- **Security code (5 to 10 digits):** The security code helps to protect your phone against unauthorised use. The preset code is 12345. Change the code, and keep the new code confidential and in a safe place separate from your phone. You can set the phone to request the code, see [Security settings](#) on page 101.

If you key in an incorrect security code five times in succession, the phone ignores further entries of the code. Wait for 5 minutes, and key in the code again.

- **PIN and PIN2 codes (4 to 8 digits):**

The PIN (Personal Identification Number) code helps to protect your SIM card against unauthorised use. The PIN code is usually supplied with the SIM card. You can set the phone to request the PIN code each time the phone is switched on, see [Security settings](#) on page 101.

The PIN2 code may be supplied with the SIM card and is required to access some functions.

- **Module PIN and signing PIN:**

The module PIN is required to access the information in the security module, see [Security module](#) on page 140.

The signing PIN is required for the digital signature, see [Digital signature](#) on page 142. The module and signing PIN are supplied with the SIM card if the SIM card has a security module in it.

If you key in an incorrect PIN code three times in succession, the phone may display *PIN blocked* or *PIN code blocked*, for example, and ask you to enter the PUK code.

- **PUK and PUK2 codes (8 digits):** The PUK (Personal Unblocking Key) or PUK2 code is required to change a blocked PIN code or PIN2 code.

If the codes are not supplied with the SIM card, contact your local service provider for the codes.

- **Barring password (4 digits):** The barring password is required when using the [Call barring service](#), see [Security settings](#) on page 101. You can obtain the password from your service provider.
- **Wallet code (4 to 10 digits):** The wallet code is required to access the wallet services, see [Wallet](#) on page 124. If you key in an incorrect wallet code three times, the wallet application is blocked for 5 minutes. After the next three incorrect attempts, the length of time for which the application is blocked will be doubled.

■ Configuration settings service

In order to use multimedia and instant messaging, and other wireless services, you need to have the proper configuration settings on your phone. You may receive the settings directly as a configuration message, and you need to save the settings on your phone. For more information on the availability of the settings, contact your network operator, service provider or nearest authorised Nokia dealer.

You may receive the configuration settings for multimedia messages, instant messaging and presence, push to talk, e-mail application, synchronisation, streaming, and for the browser.

When you have received the settings as a configuration message, and the settings are not automatically saved and activated, *Configuration sett. received* is displayed.

To view the received settings, press **Show**.

- To save the settings, press **Save**. If the phone requests *Enter settings' PIN*; key in the PIN code for the settings, and press **OK**. To receive the PIN code, contact the service provider that supplies the settings.

If no settings are saved yet, these settings are saved and set as default configuration settings. Otherwise, the phone asks *Set as default settings?*

- To discard the received settings, press **Discard**.

1. Getting started

■ Opening the fold

When you open the fold of the phone, it opens up to approximately 150 degrees. Do not try to force the fold open more.

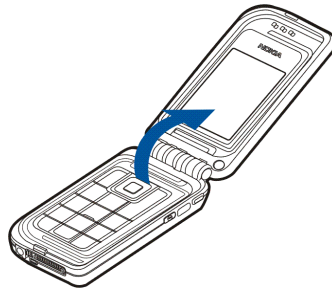

■ The wraps of the phone

You can personalise your phone with replaceable textile wraps.

To insert a wrap, fasten it on the phone according to the picture.

To remove the wrap, first loosen it from both sides of the hinge (1), then from the ends of the phone (2).

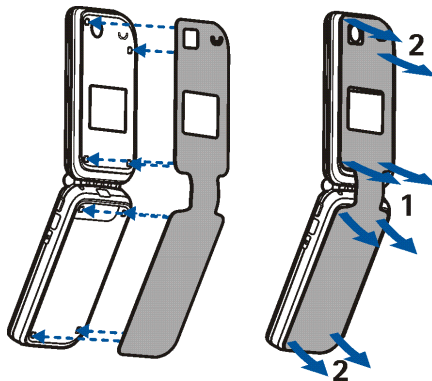

Maintaining the textile wraps

You can dust the textile wrap daily using a soft brush or a dry cloth.

To clean the textile wrap, remove the wrap and run a slightly damp white cotton cloth over them. Avoid the use of printed absorbent cloths/papers as they can release ink onto the textile.

To clean the wrap more thoroughly, remove the wrap from the phone and dust it with care. You can wash the wrap with water at approximately 30°C and a mild detergent. Do not spin-dry. Always let the wrap dry thoroughly before attaching it to the phone. Brush it delicately with a soft bristle brush.

■ Installing the battery and the SIM card

Keep all SIM cards out of the reach of small children. For availability and information on using SIM card services, contact your SIM card vendor. This may be the service provider, network operator, or other vendor.

Always switch the device off and disconnect the charger before removing the battery.

1. With the phone fold closed and the back of the phone facing you, press the release button, and lift the cover to remove it from the phone (1).

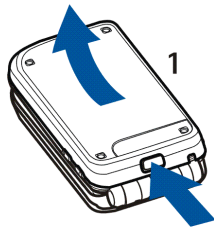

2. Lift out the battery (2).



3. To release the SIM card holder, gently pull the locking clip, and open the holder (3). Insert the SIM card into the SIM card holder so that the golden contact area on the card is facing downwards (4). Ensure that the SIM card is properly inserted. Close the cover of the SIM card holder (5), and press it gently to snap into place.

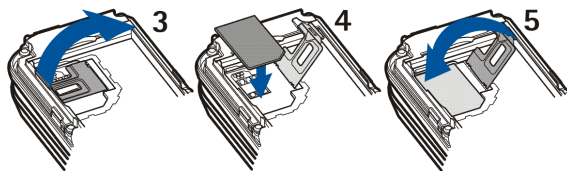

4. Replace the battery (6).

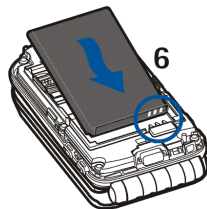

5. Place first the locking catches in the cover to the locking catches on the phone (7), then press the other end of the cover into place (8).

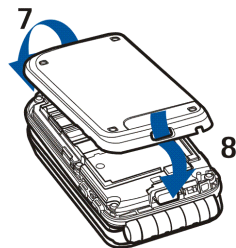

■ Attaching the wrist strap

Remove the cover from the phone. See step 1 in [Installing the battery and the SIM card](#) on page 21.

Thread the strap as shown in the picture.

Close the cover. See step 5 in [Installing the battery and the SIM card](#) on page 21.

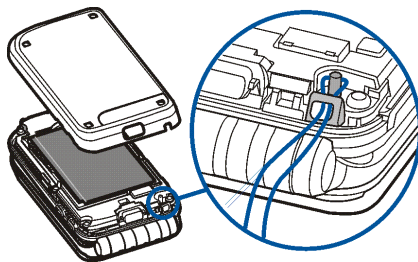

■ Charging the battery



Warning: Use only batteries, chargers, and enhancements approved by Nokia for use with this particular model. The use of any other types may invalidate any approval or warranty, and may be dangerous.

Check the model number of any charger before use with this device. This device is intended for use when supplied with power from ACP-12, ACP-7, AC-1, and LCH-12.

1. Connect the lead from the charger to the socket on the bottom of your phone.
2. Connect the charger to an AC wall socket.

The battery indicator scrolls during charging, and when the power is on, *Charging* is displayed briefly when the charging starts. If the battery is completely discharged, it may take a few minutes before the charging indicator appears on the display or before any calls can be made.

You can use the phone while the charger is connected.

The charging time depends on the charger and the battery used. For example, charging a BL-4C battery with the AC-1 charger takes approximately 1 hour and 30 minutes while the phone is in standby mode.

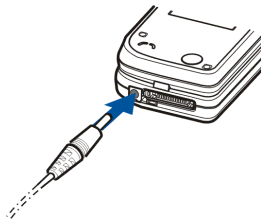

■ Switching the phone on and off

To switch the phone on or off, press and hold the power key.

If the phone displays *Insert SIM card* even though the SIM card is properly inserted, or *SIM card not supported*, contact your network operator or service provider.

If the phone requests a PIN code or a security code, open the fold, key in the code, and press **OK**. See also [Access codes](#) on page 16.

Your device has an internal antenna.



Note: As with any other radio transmitting device, do not touch the antenna unnecessarily when the device is switched on. Contact with the antenna affects call quality and may cause the device to operate at a higher power level than otherwise needed. Avoiding contact with the antenna area when operating the device optimises the antenna performance and the battery life.

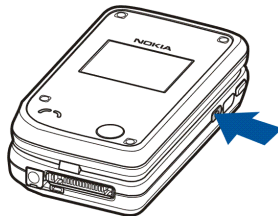

Hold the phone in the normal position.

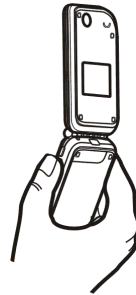

2. Your phone

■ Introduction to the phone - fold closed

1. Mini display
2. Loudspeaker
3. Charger connector
4. Microphone
5. Pop-Port™ connector used, for example, for headsets and the data cable.
6. Camera lens
7. Power key switches the phone on and off.

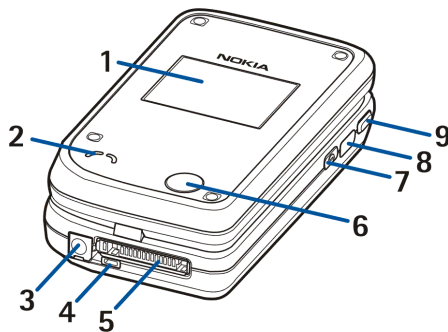

To turn the display lights on for approximately 15 seconds when the keypad is locked, press the power key briefly.

When the keypad is not locked, you can change the profiles; to access the profiles and to scroll through them, press the power key briefly, and to activate a profile, press and hold the power key. See [Profiles](#) on page 89.



8. Infrared (IR) port

9. Push to talk key to make a push to talk call. See [Making and receiving a push to talk call](#) on page 112.

■ Introduction to the phone - fold open

1. Ear piece



2. Main display

3. Left selection key ,
middle selection key ,
right selection key 

The function of these keys depends on the guiding text shown on the display above the keys. See [Standby mode](#) on page 30.

4.  ends an active call.

Press and hold to exit from any function.

5.  -  wxyz enter numbers and characters.

*+ and # are used for various purposes in different functions.

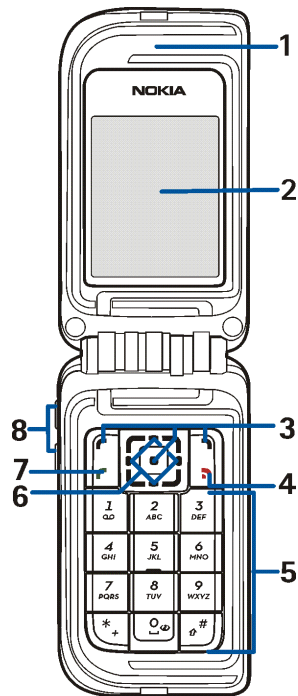

6. **4-way scroll key:**
up, down, left, right

Enables, for example, scrolling through contacts, menus or settings, in calendar, or moving the cursor when writing text.

7. Call key  dials a phone number, and answers a call.

8. **Volume keys** to adjust the volume of the earpiece or the loudspeaker, or the headset when it is connected to the phone.

When the fold is closed, to mute the ringing tone of an incoming call, to switch the alarm clock to snooze, or to mute, for example, the calendar note alarm.

■ Standby mode

When the phone is ready for use, and you have not keyed in any characters, the phone is in standby mode.

Mini display

When the fold is closed, the mini display may show the following:

- The signal strength of the cellular network at your current location and the battery charge level. Refer to [Main display](#) on page 31.
- The name of the network, or if the phone is not in service, it is indicated by a text note.

- The time and date, the active profile and the alarm clock or calendar note alerts.
- When you have an incoming call, the caller's name or number is shown if it is identified. Refer to [Answering or rejecting a call](#) on page 38.

Main display

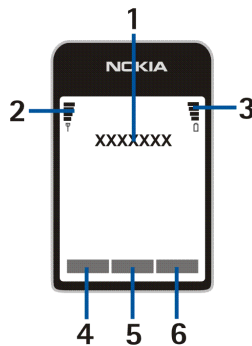

1. Shows the name of the network or the operator logo to indicate in which cellular network the phone is currently being used.
2. Shows the signal strength of the cellular network at your current location. The higher the bar, the stronger the signal.
3. Shows the battery charge level. The higher the bar, the more power in the battery.
4. The left selection key  in standby mode is **Go to**. You can use the key as a shortcut to your favourite functions.



To view the list of functions that you have on your personal shortcut list, press **Go to**. To activate a function, scroll to it, and press **Select**.

- To add more functions to the shortcut list, press **Options**, and select **Select options**. Scroll to a function, and press **Mark** to add it to the shortcut list. To remove a function from the list, press **Unmark**.

If there are no functions on the shortcut list, press **Add** to add a function.

- To arrange the functions on the list, press **Options**, and select **Organise**. Scroll to the function that you want to move, press **Move**, and select where you want to move the function.
5. The middle selection key  in standby mode is **Menu**.
 6. The right selection key  in standby mode may be **Names** to access the **Contacts** menu, an operator-specific key to access an operator's homepage, or a specific function that you have selected in the **Right selection key** menu. See [Personal shortcuts](#) on page 93.

Wallpaper













You can set your phone to display a background picture (wallpaper) for the main and mini displays in standby mode.











Screen saver

You can select an image for the screen saver on mini display and set the phone to activate it after a certain length of time if no phone function is used. See [Screen saver](#) in [Mini display settings](#) on page 91.

The phone automatically activates the digital clock screen saver on main display in standby mode, and also on mini display. If you have not set the time, 00:00 is displayed.

Essential indicators in standby mode



-  You have received one or more text or picture messages.
-  You have received one or more multimedia messages.
-  The phone has registered a missed call.
-  or  Your phone is connected to the instant messaging service, and the availability status is online or offline.
-  You have received one or more instant messages, and you are connected to the instant messaging service.
-  The phone keypad is locked.
-  The phone does not ring for an incoming call or text message when *Incoming call alert* is set to *Off*, and/or none of the caller groups has been set to alert in the *Alert for* setting, and *Message alert tone* is set to *Off*.
-  The alarm clock is set to *On*.
-  The timer is running.
-  The stopwatch is running in the background.
-  The (E)GPRS connection mode *Always online* is selected and the (E)GPRS service is available.
-  An (E)GPRS connection is established.

-  The (E)GPRS connection is suspended (on hold), for example if there is an incoming or outgoing call during an (E)GPRS dial-up connection.
-  The infrared connection indicator is shown continuously when the IR connection is activated.
- 1** or **2** If you have two phone lines, the indicator displays the selected phone line.
-  All incoming calls are diverted to another number, *Divert all voice calls*. If you have two phone lines, the divert indicator for the first line is **1** and for the second line **2**.
-  The loudspeaker is activated.
-  Calls are limited to a closed user group.
-  A headset, handsfree, loopset, or music stand is connected to the phone.
-  The timed profile is selected.
-  Push to talk connection is active or suspended.

Time and date

See [Time and date settings](#) on page 92.

Some shortcuts in standby mode

- To access the list of dialled numbers, press the left selection key  once. Scroll to the number or name that you want, and press the call key  to call the number.
- To call your voice mailbox (network service) when you have saved your voice mailbox number in the phone, press and hold **100**.
- To make a connection to a browser service, press and hold **09**.
- To access the Nokia.com page, press and hold ***7**.
- To open the push to talk *Group list* (network service), press the scroll key right.
- To find a contact name, press the scroll key down.
- To start writing text messages quickly, press the scroll key left.
- To open the camera viewfinder in standard photo view, press the scroll key up. To quickly change the camera mode, for example video, press and hold the scroll key left or the scroll key right.
- To change the profile, open the list of profiles and scroll to the desired profile by briefly pressing the power key. To activate the profile, press **Select**.

■ Keypad lock (Keyguard)

The keyguard disables the keys to prevent them from being accidentally pressed.

- To lock the keypad in standby mode, press **Menu** and * + within 1.5 seconds. The keyguard is not activated when you close the fold.
- To unlock the keypad, open the fold, press **Unlock** and * + within 1.5 seconds.

To answer a call when the keyguard is on, open the fold, or press the call key . During a call, the phone can be operated normally. When you end or reject the call, the keyguard will automatically be on again.

For security keypad locking, see *Security keyguard* in the [Phone settings](#) section on page 98.

For locking the keypad during a call, see [Options during a call](#) on page 39.



When the keyguard is on, calls still may be possible to the official emergency number programmed into your device. Key in the emergency number and press the call key .

3. Call functions

■ Making a call

1. Open the fold and key in the phone number, including the area code. If you key in an incorrect character, press **Clear** to delete it.

For international calls, press *+ twice for the international prefix (the + character replaces the international access code), and then key in the country code, the area code without the leading 0, if necessary, and the phone number.

2. To call the number, press the call key .
3. To end the call or to cancel the call attempt, press  or close the fold.

Making a call using contacts

To search for a name or phone number that you have saved in **Contacts**, press the scroll key down in standby mode. Scroll to the name or phone number, and to call the number, press the call key .

Speed dialing

Before you can use speed dialing, assign a phone number to one of the speed-dialing keys, from **2**_{ABC} to **9**_{WXYZ}. See **Speed dials** in **Other functions in the Contacts** on page **86**. Call the number in one of the following ways:



- Press the speed-dialing key that you want, and press the call key .
- If *Speed dialling* is set to on, press and hold a speed-dialing key until the call is started. You can switch the *Speed dialling On or Off*. See [Call settings](#) on page 96.

■ Answering or rejecting a call

To answer an incoming call when the fold is closed, open the fold. To reject an incoming call when the fold is closed, open the fold, and within 1.5 seconds, close it again, or press .

- If you press either of the volume keys instead of answering the call, only the ringing tone is muted.

To answer an incoming call when you have set *Answer when fold is opened* to *Off*, open the fold, and press the call key . Refer to [Call settings](#) on page 96.

To answer an incoming call when the fold is open, press the call key , or to reject an incoming call, press .

- If you press **Options** instead of answering the call, the ringing tone is muted, and you can answer or reject the call.
- If you press **Silence**, only the ringing tone is muted. You can answer or reject the call.

To end the call, press , or close the fold.

If a compatible headset supplied with the headset key is connected to the phone, you can answer and end a call by pressing the headset key.

When somebody is calling you, the phone shows the caller's name, phone number, or the text *Private number* or *Call*. If you receive a call from someone whose phone number has the seven last digits as a contact saved in *Contacts*, the information may not be displayed correctly.

■ Options during a call

Many of the options that you can select during a call are network services. To check availability, contact your network operator or service provider.

During a call, press **Options** to select from the following:

- *Mute* or *Unmute*, *End call*, *End all calls*, *Contacts*, *Menu* and *Hold* or *Unhold*, *Lock keypad*, *Record*, *New call* (network service), *Answer* and *Reject*.
- *Conference* to make a conference call that allows up to five persons to participate (network service). During a call, make a call to a new participant (*New call*). The first call is put on hold. When the new call is answered, select *Conference* to include the first participant in the conference call. To have a private conversation with one of the participants, select *Private call*, and select the desired participant. To rejoin the conference call, select *Add to conference*.
- *Send DTMF* to send DTMF (Dual Tone Multi-Frequency) tone strings, for example, passwords or bank account numbers. The DTMF system is used by all touch-tone telephones. You can key in the wait character w and the pause character p by repeatedly pressing * +.
- *Swap* to switch between the active call and the call on hold (network service), *Transfer* to connect a call on hold to an active call, and disconnect yourself from the calls (network service).

- **Loudspeaker** to use your phone as a loudspeaker during a call. The loudspeaker is automatically deactivated when you end the call or call attempt or connect the handsfree unit or headset to the phone.



When you have activated the loudspeaker, you can also close the fold of the phone during a call. First press **Options**, and then close the fold within 5 seconds.



Warning: Do not hold the device near your ear when the loudspeaker is in use, because the volume may be extremely loud.

4. Writing text

You can key in text, for example, when writing messages, using traditional or predictive text input.

When you write text,  appears at the top of the display, indicating the predictive text input, and  appears, indicating the traditional text input. **abc**, **abc**, or **ABC** appears next to the text input indicator, indicating the character case. To change the character case, press **#↑**. **123** indicates number mode. To change from letter to number mode, press and hold **#↑**, and select *Number mode*. To revert to letter mode, press and hold **#↑**.

■ Setting predictive text input on and off

When you write text, press **Options**. To set the predictive text input on if it is available for the language, select *Dictionary on*, or to revert to traditional text input, select *Dictionary off*.



Tip: To quickly set the predictive text input on or off when writing text in letter mode, press **#↑** twice, or press and hold **Options**.

■ Selecting the writing language

When you write text in letter mode, press **Options**, or press and hold **#↑**. To temporarily change the language for writing text, select *Writing language*.

To set different language for writing text and for the texts shown on the display, press **Menu**, and select *Settings*, *Phone settings*, and *Language settings*.

■ Using predictive text input

The predictive text input is based on a built-in dictionary to which you can also add new words. You can key in a letter with a single keypress.

1. Start writing a word using the keys **2**_{ABC} to **9**_{WXYZ}. Press each key only once for an individual letter. The word changes after each keystroke.
2. When you have finished writing the word and it is correct, confirm it by adding a space with **0**_↵ or by pressing any of the scroll keys. Press a scroll key to move the cursor.

If the word is not correct, press *** +** repeatedly; or press **Options**, select *Matches*, and scroll through the list of words. When the word that you want appears, confirm it.

If the ? character is displayed after the word, the word that you intended to write is not in the dictionary. To add the word to the dictionary, press **Spell**, key in the word (traditional text input is used), and press **Save**. When the dictionary is full, the new word replaces the oldest one that was added.

Writing compound words

Key in the first part of the word, and to confirm it, press the scroll key right. Write the last part of the word, and confirm the word.

■ Using traditional text input

Press a number key, **2**_{ABC} to **9**_{WXYZ}, repeatedly until the desired character appears. Not all characters available under a number key are printed on the key. The characters available depend on the language selected for writing text.

- If the next letter that you want is located on the same key as the present one, wait until the cursor appears, or press any of the scroll keys, and key in the letter.
- The most common punctuation marks and special characters are available under the number key **1**₀₌.

■ Tips for writing text

The following functions may also be available for writing text:

- To insert a space, press **0**_☐.
- To insert a number while in letter mode, press and hold the desired number key.
- To move the cursor to the left, right, down, or up, press the corresponding scroll key.
- To delete a character to the left of the cursor, press **Clear**. Press and hold **Clear** to delete the characters more quickly.

To delete all the characters at once when writing a message, press **Options** and select *Clear text*.

- To insert a word when using the predictive text input, press **Options**, and select *Insert word*. Write the word using the traditional text input, and press **Save**. The word is also added to the dictionary.
- To insert a special character when using the traditional text input, press *+. When using the predictive text input, press and hold *+, or press **Options**, and select *Insert symbol*. To insert a smiley when using traditional text input, press *+ twice. When using predictive text input, press and hold *+ for special characters, and press once again for smileys. Scroll to a character and press **Use** to select it.

The following options are available when writing text messages:

- To insert a number while in letter mode, press **Options**, and select *Insert number*. Key in the phone number, or search for it in *Contacts*, and press **OK**.
- To insert a name from *Contacts*, press **Options**, and select *Insert contact*. To insert a phone number or a text item attached to the name, press **Options**, and select *View details*.

5. Using the menu

The phone offers you an extensive range of functions that are grouped into menus. Most of the menu functions are provided with a brief help text. To view the help text, scroll to the menu function that you want and wait for 15 seconds. To exit the help text, press **Back**. You can set the phone to display or hide the menu help texts in the *Help text activation* menu. See [Phone settings](#) on page 98.

■ Accessing a menu function

By scrolling

1. To access the menu, press **Menu**.
2. Scroll up or down through the menu list, or scroll with any of the scroll keys if the grid menu view is selected.
Select, for example, *Settings* by pressing **Select**.
You can change the menu view in the *Menu view* submenu. See [Main display settings](#) on page 91.
3. If the menu contains submenus, select the one that you want, for example *Call settings*.
4. If the selected submenu contains further submenus, repeat step 3.
5. Select the setting of your choice.
6. To return to the previous menu level, press **Back**, and to exit the menu, press **Exit**.

By a shortcut

The menus, submenus and setting options are numbered, and you can access some of them by using their shortcut number.

To access the menu, press **Menu**. Key in quickly, within 2 seconds, the index number of the menu function that you want to access.

To return to the previous menu level, press **Back**, and to exit the menu, press **Exit**.

■ List of menu functions

1. Messages

1. Create message
2. Inbox
3. Outbox
4. Sent items
5. Saved items
6. Instant messages
7. E-mail
8. Voice messages
9. Info messages
10. Service commands
11. Delete messages
12. Message settings
13. Message counter



2. Contacts

1. Search
2. Add new contact
3. Delete
4. My presence
5. Subscribed names
6. Copy
7. Settings



- 8. Speed dials
 - 9. Voice tags
 - 10. Info numbers¹
 - 11. Service numbers¹
 - 12. My numbers²
 - 13. Caller groups²
- 3. Call register**
- 1. Missed calls
 - 2. Received calls
 - 3. Dialed numbers
 - 4. Delete recent call lists
 - 5. Call duration
 - 6. GPRS data counter
 - 7. GPRS connection timer
 - 8. Message counter
 - 9. Positioning
- 4. Settings**
- 1. Profiles
 - 2. Themes
 - 3. Tone settings



-
- 1. Shown if supported by your SIM card. To check availability, contact your network operator or service provider.
 - 2. If Info numbers, Service numbers or both are not supported, the number of this menu item changes accordingly.

4. Main display settings
 5. Mini display settings
 6. Time and date settings
 7. Personal shortcuts
 8. Connectivity
 9. Call settings
 10. Phone settings
 11. Enhancement settings¹
 12. Configuration settings
 13. Security settings
 14. Restore factory settings
- 5. Gallery**
1. Images
 2. Video clips
 3. Themes
 4. Graphics
 5. Tones
 6. Recordings
- 6. Media**
1. Camera
 2. Media player



1. This menu is shown only if the phone is or has been connected to a compatible enhancement available for the phone.

3. Radio
4. Voice recorder
- 7. Push to talk**
 1. Switch PTT on /Switch PTT off
 2. Callback inbox
 3. Group list
 4. Contacts list
 5. Add group
 6. PTT settings
 7. Configuration settings
 8. Services



- 8. Organiser**

1. Alarm clock
2. Calendar
3. To-do list
4. Notes
5. Synchronisation
6. Wallet
7. Calculator
8. Stopwatch
9. Countdown timer



9. Applications

1. Games
2. Collection



10. Web

1. Home
2. Bookmarks
3. Download links
4. Last web addr.
5. Service inbox
6. Settings
7. Go to address
8. Clear the cache



11. SIM services¹



1. Only shown if supported by your SIM card. The name and contents vary depending on the SIM card.

6. Menu functions

■ Messages



You can read, write, send, and save text, multimedia, and e-mail messages. All messages are organised into folders.



Note: When sending messages, your device may display the words *Message sent*. This is an indication that the message has been sent by your device to the message centre number programmed into your device. This is not an indication that the message has been received at the intended destination. For more details about messaging services, check with your service provider.

Text messages (SMS)

Using the Short Message Service (SMS) you can send and receive multi-part messages made of several ordinary text messages (network service) that can contain pictures.

Before you can send any text, picture, or e-mail message, you need to save your message centre number, see [Message settings](#) on page 72.

Your device supports the sending of text messages beyond the normal 160-character limit. If your message exceeds 160 characters, it will be sent as a series of two or more messages.

At the top of the display you can see the message length indicator counting backwards from 160. For example, 10/2 means that you can still add 10 characters for the text to be sent as two messages.

Note that using special (Unicode) characters such as ã, â, á, ì take up more space.



Note: Only phones that offer picture message features can receive and display picture messages.

Writing and sending SMS messages

1. Press **Menu**, and select *Messages*, *Create message*, and *Text message*.
2. Write the message. See [Writing text](#) on page 41.

You can insert text templates or a picture into the message. See [Templates](#) on page 54. Each picture message comprises several text messages. Sending one picture or multi-part message may cost more than sending one text message.

3. To send the message, press **Send** or the call key .
4. Enter the recipient's phone number, or press **Search** to retrieve a phone number from *Contacts*, and press **OK**.



Options for sending a message



After you have written a message, press **Options**, and select *Sending options* and one of the following options:

- To send a message to several recipients, select *Send to many*. The message is sent separately to each recipient, which may cost more than sending one message.
- To send a message as SMS e-mail, select *Send as e-mail*. Key in the recipient's e-mail address, or search for it in *Contacts*, and press **OK**.
- To send a message using a predefined message profile, select *Sending profile* and a message profile.



To define a message profile, see [Message settings](#) on page 72.

Reading and replying to an SMS message

The indicator  is shown when you have received a message or an e-mail using SMS. The blinking  indicates that the message memory is full. Before you can receive new messages, delete some of your old messages in the *Inbox* folder.

1. To view a new message, press **Show**, or to view it later, press **Exit**.
To read the message later, press **Menu**, and select *Messages*, and *Inbox*. If more than one message is received, select the message you want to read. An unread message is indicated by  in front of it on the list of messages.
2. While reading a message, press **Options**. You can select to delete, forward, edit the message as a text message or as an e-mail, move it to another folder, or extract message details. You can also copy text from the beginning of a message to your phone calendar as a reminder note. When reading a picture message, you can save the picture in the *Templates* folder.
3. To reply to a message, press **Reply**. To reply as a text message, select *Text message*, or to reply as a multimedia message, select *Multimedia msg*.
When replying to an e-mail, first confirm or edit the e-mail address and subject, then write your reply message.
4. To send the message to the displayed number, press **Send** or the call key  and **OK**.

Templates

To access the template list, press **Menu**, and select *Messages*, *Saved items*, *Text messages* and *Templates*. To add a text () or picture () template in a

message, select it, press **Options**, and to complete the message, select *Edit* (or *Edit text* for picture template).

To add a template while you are writing or replying to a message, press **Options**, and select *Use template* to insert a text template into the message or the e-mail. Select *Insert picture* to insert a picture into the text message.

Multimedia messages



Note: Only devices that offer compatible multimedia message or e-mail features can receive and display multimedia messages.

To check availability and to subscribe to the multimedia messaging network service, contact your network operator or service provider. See [Settings for multimedia messages](#) on page 73.

A multimedia message can contain text, sound, a picture, a calendar note, a business card, or a video clip. If the message is too large, the phone may not be able to receive it. Some networks allow text messages that include an Internet address where you can view the multimedia message.

You cannot receive multimedia messages during a call, a game, another Java application, or an active browsing session over GSM data. Because delivery of multimedia messages can fail for various reasons, do not rely solely upon them for essential communications.

Writing and sending a multimedia message

1. To create and send a multimedia message, press **Menu**, and select *Messages*, *Create message*, and *Multimedia msg*.

2. Key in the message. See [Writing text](#) on page 41.
 - To insert a file in the message, press **Options**, select *Insert*, and select the desired option. You cannot select an option if it is dimmed.

If you select *Image*, *Sound clip*, or *Video clip*, the list of available folders in the *Gallery* is shown. Open a specific folder, scroll to the desired file, press **Options**, and select *Insert*. The file is attached when the file name appears in the message.

If you select *New sound clip*, the voice recorder is opened, and you can start a new recording. When you end the recording, it is added to the message.
 - To insert a business card or a calendar note in the message, press **Options**, select *Insert* and *Business card* or *Calendar note*.
 - Your phone supports multimedia messages that contain several pages (slides). Each slide can contain text, one image, a calendar note, a business card, and one sound clip. To insert a slide in the message, press **Options**, and select *Insert* and *Slide*.

To open a desired slide if the message contains several slides, press **Options**, and select *Previous slide*, *Next slide* or *Slide list*.

To set the interval between the slides, press **Options**, and select *Slide timing*. To move the text component to the top or bottom of the message, select *Place text first* or *Place text last*.
3. To view the message before sending it, press **Options**, and select *Preview*.
4. To send the message, press **Send** or the call key , and select *Phone number*.

To send the message to an e-mail address or to many recipients, select *E-mail address* or *Many*.

5. Enter the recipient's phone number (or e-mail address) or search for it in *Contacts*. Press **OK** and the message is moved to the *Outbox* folder for sending.

It takes more time to send a multimedia message than to send a text message. While the multimedia message is being sent, the animated  is displayed, and you can use other functions on the phone. If an interruption occurs while the message is being sent, the phone tries to resend the message a few times. If these attempts fail, the message remains in the *Outbox* folder. You can try to resend it later.

The sent message is saved in the *Sent items* folder if the setting *Save sent messages* is set to *Yes*. See [Settings for multimedia messages](#) on page 73.

When the message is sent, it is not an indication that the message has been received at the intended destination.

Copyright protections may prevent you from copying, modifying, transferring, or forwarding some images, ringing tones, and other content.



Reading and replying to a multimedia message





Important: Multimedia message objects may contain viruses or otherwise be harmful to your device or PC. Do not open any attachment if you are not sure of the trustworthiness of the sender.

The default setting of the multimedia message service is generally on.

The appearance of a multimedia message may vary depending on the receiving device.

When the phone is receiving a multimedia message, the animated  is displayed. When the message is received,  and the text *Multimedia message received* are shown.

The blinking  indicates that the memory for multimedia messages is full. See [Multimedia messages memory full](#) on page 59.

1. To read a received multimedia message, press **Show**, or to view it later, press **Exit**.
To read the message later, press **Menu**, and select *Messages*, and *Inbox*. On the list of messages, an unread message is indicated by . Scroll to the message that you want to view, and press **Select**.
2. The function of the middle selection key changes according to the currently displayed attachment in the message.
 - To view the whole message if the received message contains a presentation, press **Play**.
Otherwise, press **Play** to listen to a sound clip or view a video clip attached to the message. To zoom in on an image, press **Zoom**. To view a business card or a calendar note, press **View**. To open a theme object, press **Open**. To open a streaming link, press **Load**.
3. To reply to the message, press **Options**, and select *Reply*, and *Text message*, or *Multimedia msg*. Key in the reply message, and press **Send**. You can send the reply message only to the person who sent you the original message.
4. Press **Options**, and you can also, for example, open and save the attached file or to view its details, and to delete, or forward the message.

After you have sent the reply message, you can edit it and, for example, send it to other persons, or send it as an e-mail.

Multimedia messages memory full

When you have a new multimedia message waiting and the memory for the messages is full,  blinks and *Multimedia memory full, view waiting msg.* is shown. To view the waiting message, press **Show**. To save the message, press **Save** and delete old messages by first selecting the folder and then the old message to be deleted.

To discard the waiting message, press **Exit** and **Yes**. If you press **No**, you can view the message.

Inbox, Outbox, Saved items and Sent items folders

- The phone saves in the *Inbox* folder the text and multimedia messages that have been received.
- Multimedia messages that have not yet been sent are moved to the *Outbox* folder.
- The sent messages are saved in the *Sent items* folder if the settings *Save sent messages* for text messages and *Save sent messages* for multimedia messages in *Message settings* are set to **Yes**.
- To save the text message that you are writing and wish to send later in the *Saved items* folder, press **Options**, and select *Save message*, and *Saved text*

msgs. For multimedia messages, select the option *Save message*. Unsent messages are indicated with .

- To organise your text messages, you can move some of them to *My folders*, or add new folders for your messages. Select *Messages*, *Saved items*, *Text messages* and *My folders*.

To add a folder, press **Options**, and select *Add folder*. If you have not saved any folders, press **Add**.

To delete or rename a folder, scroll to the desired folder, press **Options**, and select *Delete folder* or *Rename folder*.

Instant messages

Instant messaging (network service) is a way to send short, simple text messages to online users, delivered over TCP/IP protocols. Your contact list shows you when your contacts on the list are online and available to participate in an instant messaging conversation. When you have written and sent your message, it remains displayed. The reply message appears below your original message.

Before you can use instant messaging, you need to subscribe to the service. To check the availability and charging and to subscribe to the service, contact your network operator or service provider, from whom you also receive your unique ID and password and the settings for the instant messaging.

To set the required settings for the instant messaging service, see *Connect settings* in the section [Entering the instant messaging menu](#) on page 61.

While you have connected to the instant messaging service, you can use the other functions of the phone, and the instant messaging session remains active in the background. Depending on the network, the active instant messaging session may consume the phone battery faster, and you may need to connect the phone to a charger.

Entering the instant messaging menu

To enter the *Instant messages* menu while still offline, press **Menu**, and select *Messages* and *Instant messages*.

- To connect to the instant messaging service, select *Login*. You can set the phone to automatically connect to the instant messaging service when you enter the *Instant messages* menu. See [Connecting to and disconnecting from the instant messaging service](#) on page 62.
- To view, erase, or rename the conversations that you have saved during an instant messaging session, select *Saved convers.*. You can select *Saved convers.* also when you have connected to the instant messaging service.
- To view the settings needed for instant messaging and presence settings, select *Connect. settings*.

You may receive the settings as a configuration message, see [Configuration settings service](#) on page 18. To key in the settings manually, see [Configuration settings](#) on page 99.

Select *Configuration* and *Default* or *Personal config.* according to which configuration settings supports instant messaging.

Select *Account* and select an instant messaging account provided by the service provider.

Select *User ID* to key in your user ID received from the service provider.

Select *Password* to key in the password received from the service provider.

Connecting to and disconnecting from the instant messaging service

To connect to the instant messaging service, enter the *Instant messages* menu, select the desired instant messaging service if needed, and select *Login*. When the phone has successfully connected, *Logged in* is displayed. To disconnect from the instant messaging service, select *Logout*.



Tip: To set the phone to automatically connect to the instant messaging service when you enter the *Instant messages* menu, connect to the instant messaging service, select *My settings*, *Automatic login* and *On IM start-up*.

Starting an instant messaging conversation

Enter the *Instant messages* menu, connect to the instant messaging service, and you can start a conversation in different ways.

- Select *Conversations*. The list of new and read messaging sessions or invitations to instant messaging during the currently active session is displayed. Scroll to a message or an invitation, and press **Open**.

 indicates the new and  the read instant messages.

 indicates the new and  the read group messages.

 indicates the invitations.

The icons and texts on the display may vary depending on the instant messaging service.

- Select *IM contacts*. The contacts that you have added from the phone's contacts memory are displayed. Scroll to the contact with whom you would like to start instant messaging, and press **Chat**.



indicates that you have received a new message from a contact.



indicates an online contact and  an offline contact in the contact memory of the phone.



indicates a blocked contact. Refer to [Blocking and unblocking messages](#) on page 66.

You can add contacts to the list. See [Contacts for instant messaging](#) on page 66.

- Select *Groups* and *Public groups* (dimmed if the group functionality is not supported by the network). The list of bookmarks to public groups provided by the network operator or service provider is displayed. To start a conversation, scroll to a group, and press **Join**. Enter the screen name that you want to use as a nickname in the conversation. When you have successfully joined in the group conversation, you can start a group session. You can also create a private group. See [Groups](#) on page 67.
- Select *Search* and *Users* or *Groups* to search for other instant messaging users or public groups on the network by phone number, screen name, e-mail address, or name. If you select *Groups*, you can search for a group by a member in the group or by group name, topic or ID.

To start the session when you have found the user or the group that you want, press **Options**, and select *Chat* or *Join group*.

- You can start a session from Contacts. See [Viewing the subscribed names](#) on page 83.

Accepting or rejecting an instant messaging invitation

In standby mode, when you are connected to the instant messaging service and you receive a new invitation, *New invitation received* is displayed. Press **Read** to read it. If more than one invitation is received, scroll to an invitation, and press **Open**.

- To join the private group conversation, press **Accept**. Enter the screen name that you want to use as a nickname in the conversation.
- To reject or delete the invitation, press **Options** and select *Reject* or *Delete*. You can key in an explanation for the rejection.

Reading a received instant message

In standby mode, when you are connected to the instant messaging service and you receive a new message that is not a message associated with an active conversation, *New instant message* is displayed. Press **Read** to read it.

If more than one message is received, the number of messages, followed by *new instant messages*, is displayed. Press **Read**, scroll to a message and press **Open**.

New messages received during an active session are held in the *Conversations* of the *Instant messages* menu. If you receive a message from someone who is not in *IM contacts*, the sender ID is displayed. If the sender is in the phone memory and the phone recognises it, the name of the person is displayed. To save a new

contact that is not in the phone memory, press **Options** and select *Save contact*, or to add a new detail to the selected contact, select *Add to contact*.

Participating in an instant messaging conversation

Join or start a conversation by pressing **Write** or start writing.





Tip: If you receive a new message during a session from a person who is not taking part in the current session, the icon  is displayed, and the phone sounds an alert tone.

Key in your message, and press **Send** or the call key  to send it. The message stays on the display, and the reply message appears below your message.

Editing your own settings

1. Enter the *Instant messages* menu, and connect to the instant messaging service.
2. To view and edit your own availability information or screen name, select *My settings*.
 - To allow all the other instant messaging users to see you as being online, select *Availability* and *Available for all*.
 - To allow only the contacts on your instant messaging contact list to see you as being online, select *Availability* and *Avail. for contacts*.
 - To appear as being offline, select *Availability* and *Appear offline*.

When you are connected to the instant messaging service,  indicates that you are online and  that you appear as offline to others.

Contacts for instant messaging

You can add contacts to the instant messaging contacts list.

1. Connect to the instant messaging service, select *IM contacts*.
2. Press **Options** and select *Add contact*. You can select to key in the user ID, to add a contact from the phone contact memory, or to search other contacts or to copy a contact from your contact list on the service provider's server.
3. To start an instant messaging service, press **Chat**, or if there is a new message from the contact, press **Open**.
4. Press **Options** and select, for example, to view the details of a selected contact, to copy contacts from your instant messaging contact list to the service provider's server, or to select the contacts in the instant messaging list from whom you want to receive availability alerts.

Blocking and unblocking messages

To block messages, connect to the instant messaging service, and select *Conversations, IM contacts*, or join or start a session. Select the contact from whom you want to block incoming messages, and press **Options**. Select *Block contact*, and press **OK** to confirm.

To unblock messages, connect to the instant messaging service, and select *Blocked list*. Scroll to the contact from whom you want to unblock the messages, and press **Unblock**.

You can also unblock messages from the contact list.

Groups

If groups are supported by the network, you can create your own private groups that exist only during a instant messaging session, or use the public groups where provided by the service provider.



Connect to the instant messaging service, and select *Groups*.

- Select *Public groups*, press **Join** and, if you are not in the group, enter your screen name. Press **Options**, and select *Delete group* to delete a group from your group list.

Select *Search groups* to search a group by group member or by group name, topic, or ID.

- Select *Create group*. Enter the name for the group and the screen name to be used as your nickname in this group.

Mark the names in the contacts list to add them to the private group list, or unmark them to remove them from the list. You need to send an invitation to the new members in the group.

The online contacts are indicated by , the offline contacts by , and the blocked contacts by . You cannot add contacts that are dimmed in the list.

The icons may vary depending on the instant messaging service.

E-mail messages

The e-mail application that uses (E)GPRS (network service), allows you to access your e-mail account from your phone, when you are not in the office or at home. To use the e-mail function on your phone, you need a compatible e-mail system.

You can write, send, and read e-mails with your phone. You can also save and delete the e-mails on a compatible PC. Your phone supports POP3 and IMAP4 e-mail servers.

Before you can send and retrieve any e-mail messages, you may need to do the following:

- Obtain a new e-mail account or use your current account. To check the availability of your e-mail account, contact your e-mail service provider.
- Check your e-mail settings with your network operator or e-mail service provider. You can receive e-mail settings as a configuration message, see [Configuration settings service](#) on page 18.
- To check your settings, press **Menu**, and select *Messages*, *Message settings* and *E-mail messages*. See [Settings for e-mail application](#) on page 75.

This application does not support keypad tones.

Writing and sending an e-mail

You can write your e-mail message before connecting to the e-mail service, or connect to the service first, and then write and send your e-mail.

1. Press **Menu**, and select *Messages*, *E-mail* and *Create e-mail*.
2. Key in the recipient's e-mail address, or press **Edit** and key in the e-mail address, or to search for the e-mail address in *Contacts*, press **Edit** and *Options*, and select *Search*. Press **OK**.
3. You can key in a subject for the e-mail, and press **OK**.

If you press **Options**, you can select the message editor, add a new recipient, add a copy recipient, or a hidden copy recipient.

4. Key in the e-mail message, see [Writing text](#) on page 41. The number of characters that you can key in is shown on the top right of the display.
5. To send the e-mail message, press **Send**. Select *Send now* to send the e-mail immediately. If you select *Send later*, the e-mail is saved in the *Outbox* folder.

If you want to edit or continue writing your e-mail later, you can save it in *Drafts* by selecting *Save draft msg.*

When sending the e-mail later, press **Menu**, and select *Messages, E-mail*. Press **Options**, and select *Send now* or *Retrieve and send*.

Downloading e-mail messages

You can download e-mail messages from your e-mail account.

1. Press **Menu**, and select *Messages, E-mail* and *Retrieve*.

Alternatively, press **Menu**, and select *Messages, E-mail*, press **Options**, and select *Retrieve and send* to download new e-mail messages and to send e-mails that have been saved in the *Outbox* folder.

If the message memory is full, delete some of your older messages before you start to download new messages.

Your phone makes a connection to the e-mail service. A status bar is shown while your phone is downloading e-mail messages to your phone.

2. Press **Select** to view the new message in *Inbox*, or press **Back** to view it later.

If you receive more than one message, select the message that you want to read. An unread message is indicated by .

Reading and replying to an e-mail message



Important: E-mail messages may contain viruses or otherwise be harmful to your device or PC. Do not open any attachment if you are not sure of the trustworthiness of the sender.

1. Press **Menu**, select *Messages, E-mail* and *Inbox*.
2. While reading the message, press **Options** to view the details of the selected message, mark the message as unread, delete, reply, reply to all, forward or move the message to another folder.
3. To reply to an e-mail, press **Reply**. You can, for example, include the original message in the reply.

Confirm or edit the e-mail address and subject, then write your reply.

4. To send the message, press **Send** and select *Send now*.

Inbox and Other folders

Your phone has the following folders in the *E-mail* menu:

- *Inbox* for saving e-mails that you have downloaded from your e-mail account.
- *Other folders* contains the folders: *Drafts* for saving unfinished e-mails, *Archive* for organising and saving your e-mails, *Outbox* for saving e-mails that have not been sent, if you have selected *Send later*, see [Writing and sending an e-mail](#) on page 68, and *Sent items* for saving e-mails that have been sent.

Deleting e-mail messages

To delete e-mail messages, press **Menu**, and select *Messages, E-mail*. Press **Options**, and select *Delete messages*.

- To delete all messages from a folder, select the folder, and press **Yes**.
- To delete all messages from all folders, select *All messages*, and press **Yes**.

Deleting an e-mail from your phone does not delete it from the e-mail server.

Voice messages

The voice mailbox is a network service. For more information and for your voice mailbox number, contact your service provider.

Press **Menu**, and select *Messages, Voice messages* and *Listen to voice messages* to call your voice mailbox at the phone number that you have saved in the *Voice mailbox number* menu.

Info messages

With the *Info messages* network service you can receive messages on various topics from your service provider. To check availability, topics and the relevant topic numbers, contact your service provider.

Service commands

In this menu you can send service requests to your service provider (network service).

Deleting messages

To delete all messages from a folder, press **Menu**, and select *Messages, Delete messages*, and the folder from which you want to delete the messages. Press **Yes**, and if the folder contains unread messages, the phone will ask whether you want to delete them also. Press **Yes** again.

Message settings

The message settings affect the sending, receiving, and viewing of messages.

Settings for text messages

1. Press **Menu**, and select *Messages, Message settings, Text messages* and *Sending profile*.
2. If more than one message profile set is supported by your SIM card, select the profile you want to change, and select from the following settings:
 - *Message centre number* to save the phone number of the message centre that is required for sending text messages. You will receive this number from your service provider.
 - *Messages sent via* to select the message type *Text, E-mail, Paging* or *Fax*.
 - *Message validity* to select the length of time for which the network should attempt to deliver your message.
 - *Default recipient number* to save a default number for sending messages for this profile if you have selected the message type *Text*. Select *E-mail server* to save the e-mail server number if you have selected the message type *E-mail*.

- *Delivery reports* to ask the network to send delivery reports about your messages (network service).
 - *Use GPRS*, and select *Yes* to set GPRS as the preferred SMS bearer. Also, set the *GPRS connection* to *Always online*. See [GPRS connection](#) on page 95.
 - *Reply via same centre* to allow the recipient of your message to send you a reply using your message centre (network service).
 - *Rename sending profile* to change the name of the selected message profile. The message profile sets are only displayed if your SIM card supports more than one set. The default profile cannot be renamed.
3. Select *Save sent messages* and *Yes* to set the phone to save the sent text messages in the *Sent items* folder.

Settings for multimedia messages

You may receive the multimedia configuration settings as an over the air message from the network operator or service provider. To receive the settings over the air, see [Configuration settings service](#) on page 18.

Press **Menu**, and select *Messages*, *Message settings* and *Multimedia msgs.*. Select from the following settings:

- *Save sent messages*, and select *Yes* to set the phone to save sent multimedia messages in the *Sent items* folder.
- *Delivery reports* to ask the network to send delivery reports about your messages (network service).
- *Scale image down* to define the image size when you insert the image to a multimedia message.

- *Default slide timing* to select the default value for timed slides.
- *Allow multimedia reception*, and select *No* or *Yes* to receive or block multimedia messages. To receive multimedia messages only in your home network, select *In home network* (default setting).
- *Incoming multimedia messages*, and select *Retrieve* to set the phone to automatically retrieve newly received multimedia messages, or select *Reject* if you do not wish to receive multimedia messages. This setting is not shown if the *Allow multimedia reception* is set to *No*.
- *Configuration settings*, and select *Configuration*. Only the configurations that support multimedia messaging are shown. Select a service provider, or *Default*, or *Personal config.* for multimedia messaging. You may receive the multimedia messaging settings as a configuration message, see [Configuration settings service](#) on page 18. To key in the configuration settings manually, see [Configuration settings](#) on page 99.

Select *Account* and select a multimedia messaging service account contained in the active configuration settings.

- *Allow adverts*. You can receive or reject advertisements. This setting is not shown if *Allow multimedia reception* is set to *No* or if *Incoming multimedia messages* is set to *Reject*.

Settings for e-mail application

You may receive the e-mail settings as a configuration message, see [Configuration settings service](#) on page 18. To key in the settings manually, see [Configuration settings](#) on page 99.

1. Press **Menu**, and select *Messages*, *Message settings*, and *E-mail messages*.
2. Select from the following:
 - *Configuration* and select the set that you would like to activate.
 - *Account* to see the accounts provided by the service provider. If more than one account is displayed choose the one that you want to use.
 - *My name*. Key in your name or nickname.
 - *E-mail address*. Key in e-mail address.
 - *Include signature*. You can define a signature that is automatically added to the end of your e-mail, when you write your message.
 - *Reply-to address*. Key in the e-mail address to which you want the replies to be sent.
 - *SMTP user name*. Key in the name that you want to use for outgoing mails.
 - *SMTP password*. Key in the password that you want to use for outgoing mails.
 - *Display terminal window*. Select *Yes* to perform manual user authentication for Intranet connections.
 - *Incoming server type*. Select either *POP3* or *IMAP4* depending on the type of e-mail system that you are using. If both types are supported, select *IMAP4*.

- *Incoming mail settings*

If you have selected *POP3* as the incoming server type, the following options are shown: *Retrieve e-mails*, *POP3 user name*, *POP3 password* and *Display terminal window*.

If you have selected *IMAP4* as the incoming server type, the following options are shown: *Retrieve e-mails*, *Retrieval method*, *IMAP4 user name*, *IMAP4 password* and *Display terminal window*.

Other settings

To select the other settings for messages, press **Menu**, and select *Messages*, *Message settings*, *Other settings*. To change the font size for reading and writing messages, select *Font size*.

Message counter

To view how many text, and multimedia messages you have sent and received, press **Menu**, and select *Messages*, *Message counter*, and *Sent messages* or *Received messages*. To clear the counters, select *Clear counters*.

■ Contacts

You can save names and phone numbers (Contacts) in the phone memory or in the SIM card memory.



The phone supports presence enhanced contact (network service) containing *My presence* and *Subscribed names*. In the *My presence* menu you can publish your current availability status to communicate to anyone who has access to this

service and who is requesting this information. In the *Subscribed names* menu you can create a list of contacts whose presence status you would like to see and use this list to quickly view their availability status.

Searching for a contact

Press **Menu**, and select *Contacts* and *Search*, or press the scroll key down in standby mode.

Scroll up or down to the name that you want. If the contact is saved in the SIM card' memory,  is shown on the top of the display. Press **Details**, and scroll to view the details of the selected contact.

The subscribed names are shown differently, depending on the *Contacts view* selection. See [Settings for contacts](#) on page 84.

Saving names and phone numbers (Add contact)

Press **Menu**, and select *Contacts* and *Add new contact*. Key in the name, press **OK**, and key in the phone number, and press **OK**.



Tip: Quick save In standby mode, key in the phone number, and press **Save**. Key in the name, and press **OK**.

Saving multiple numbers or text items per name

You can save different types of phone numbers and short text items for a contact in the phone memory for contacts. A text item may be, for example, an address.

The first number you save is automatically set as the default number, and it is indicated with a frame around the number type indicator, for example . When you select a name from contacts, for example, to make a call, the default number is used unless you select another number.

1. Ensure that the memory in use is either *Phone* or *Phone and SIM*. See [Settings for contacts](#) on page 84.
2. To access the list of names and phone numbers, press the scroll key down in standby mode.
3. Scroll to the name to which you want to add a new number or text item.
4. Press **Details** and **Options**, and select *Add number* or *Add detail*.
5. To add a number or detail, select a number type or text type.

If you are connected to the presence service and select the text type *User ID*, select *Search* to search for an ID by a mobile phone number or an e-mail address on the server of the operator or service provider. See [Presence-enhanced contacts - My presence](#) on page 80. If only one ID is found, it is automatically saved. Otherwise, to save the ID, press **Options**, and select *Save*. Select *Enter ID manually*, key in the ID, and press **OK**.

To change the number or text type, press **Options**, and select *Change type*. You cannot change the type of an ID when it is in the *IM contacts* or *Subscribed names* list.

To set the selected number as the default number, press **Options**, and select *Set as default*.

6. Key in the number or text item, and press **OK** to save it.
7. Press **Back** and then **Exit** to return to standby mode.

Adding an image to a contact

You can add an image in a supported format to a certain number of contacts saved in the phone memory.

Press the scroll key down in standby mode, scroll to a contact to which you want to add an image, and press **Details**. Press **Options**, and select *Add image*. Open the desired folder in the *Gallery*, scroll to the image that you want to add, press **Options** and select *Save to contacts*. A copy of the image is added to the contact.

Editing or deleting details in the contacts

Search for the contact, and press **Details**. Scroll to the name, number, text item, or image that you want to edit or delete.

- To edit, press either **Edit** or **Change**, or press **Options**, and select *Edit name*, *Edit number*, *Edit detail*, or *Change image*, depending on the *Contacts view* selection. You cannot edit or delete an ID when it is on the *IM contacts* or in the *Subscribed names* list.
- To delete a number, a text item, or an image attached to the contact, press **Options**, and select *Delete number*, *Delete detail*, or *Delete image*. Deleting an image from contacts does not delete it from *Gallery*.

Deleting contacts

Press **Menu**, and select *Contacts*, and *Delete* to delete contacts and all the details attached to them. To delete contacts one by one or all at once, select *One by one* or *Delete all*.

Presence-enhanced contacts – My presence

With the presence service (network service), you can share your presence status with other users, for example, your family, friends, and colleagues. Presence status includes your availability, status message, and personal logo. Other users who have access to the service and are requesting your information, are able to see your status. The requested information is shown in *Subscribed names* in the viewers' *Contacts* menu. You can personalize the information that you want to share with others and control who can see your status.

Before you can use presence, you need to subscribe to the service. To check the availability and costs, and to subscribe to the service, contact your network operator or service provider, from whom you also receive your unique ID, password, and the settings for the service. See [Configuration settings](#) on page 99.

To use presence, connect to the service. While you are connected to the presence service, you can use the other functions of the phone, and the presence service is active in the background. If you disconnect from the service, your presence status is shown for a certain amount of time for the viewers depending on the service provider.

Press **Menu**, and select *Contacts*, and *My presence*. Select from the following options:

- *Connect to 'My presence' service* or *Disconnect* to connect to or to disconnect from the service.
- *My current presence*, and select, for example, to view your current private or public status, to change your presence status, or to select the groups with whom you want to share your presence status information.
- *Viewers*, and select to view all the persons who have subscribed to, who are allowed to view, or who are blocked from viewing your presence information.
- *Settings*, and select from following:
 - Show current presence in idle* to show the current status indicator in standby mode.
 - Synchronise with profiles* to select whether you want to update *My presence message* and *My availability* manually or automatically by linking them to the currently active profile. See [Profiles](#) on page 89. You cannot link a personalised status logo to a profile.
 - Connection type* to select how the phone connects to the presence service when it is switched on.
 - IM and my presence settings* and select from following:
 - *Configuration*. Only the configurations that support presence service are shown. Select a service provider, *Default*, or *Personal config*. for presence service. You may receive the presence service settings as a configuration message, see [Configuration settings service](#) on page 18. To key in the configuration settings manually, see [Configuration settings](#) on page 99.

- *Account* and select a presence service account contained in the active configuration settings.
- *User ID* to key in your user ID received from the service provider.
- *Password* to key in the password received from the service provider.

Presence-enhanced contacts – Subscribed names

You can create a list of contacts whose presence status information you want to be available. You can view the information only if it is allowed by your contact or the network.

Ensure that the memory in use is either *Phone* or *Phone and SIM*. See [Settings for contacts](#) on page 84.

To connect to the presence service, press **Menu**, and select *Contacts*, *My presence*, and *Connect to My presence service*. You can view the subscribed contacts even when you are not connected to the presence service, but you cannot see the presence status information about the contact.

Adding contacts to the subscribed names

1. Press **Menu**, and select *Contacts*, and *Subscribed names*.
2. If your list of contacts is empty, press **Add**. Otherwise, press **Options**, and select *Subscribe new*.
3. Select a contact from the list. If the contact has a saved ID, the contact is added to the subscribed names list.





Tip: To subscribe to a contact from the *Contacts* list, search for the contact, press **Details**, and **Options**. Select *Request presence* and *As subscription*.

To view only the presence information, select *Request presence* and *One time only*.

Viewing the subscribed names

See [Searching for a contact](#) on page 77.

1. To view the presence information, press **Menu**, and select *Contacts*, and *Subscribed names*.

The status information of the first contact on the subscribed names list is displayed. The information that the person wants to make available to others may include text and an icon. The ,  and  icons indicate that the person is either available, busy, or not available.

 indicates that the person's presence information is not available.

2. Press **Options**, and select from the list of options.

Unsubscribing a contact

To unsubscribe a contact, search for the contact from the *Contacts* list, and press **Details**. Select the user ID, press **Options**, select *Unsubscribe*, and press **OK**.

Copying contacts

Press **Menu**, and select *Contacts* and *Copy* to copy names and phone numbers from the phone memory to your SIM card memory and vice versa. The text items,

such as e-mail addresses, saved in the phone memory are not copied to the SIM card.

Settings for contacts

Press **Menu**, and select *Contacts* and *Settings*, and select from the following:

- *Memory in use* to select the memory that you want to use for your contacts. If you select *Phone and SIM*, you can view the contacts in both memories but the names and numbers will be saved in the phone memory.
- *Contacts view* to select how the contacts are displayed.
- *Memory status* to view the status of both memories for contacts.

Sending and receiving a business card

You can send and receive a person's contact information from a compatible device that supports the vCard standard as a business card.

When you have received a business card, press **Show** and **Save** to save the business card in the phone memory.

To send a business card, search for the name and phone number that you want to send from contacts. Press **Details** and **Options**, and select *Send bus. card*. Select *Via infrared*, *Via text message* (network service), or *Via multimedia* (network service).

Voice dialing

You can call a contact by saying a voice tag that you have recorded for that contact. Any spoken words, such as a name, can be a voice tag. You can add a certain amount of voice tags.

Before using voice tags, note that:

- Voice tags are not language-dependent. They are dependent on the speaker's voice.
- You must say the name exactly as you said it when you recorded it.
- Voice tags are sensitive to background noise. Record voice tags and use them in a quiet environment.
- Very short names are not accepted. Use long names and avoid similar names for different numbers.



Note: Using voice tags may be difficult in a noisy environment or during an emergency, so you should not rely solely upon voice dialing in all circumstances.

Adding and managing voice tags

Save or copy in the phone memory the contacts to which you want to add a voice tag.

1. In standby mode, press the scroll key down, and scroll to the contact to which you want to add a voice tag.
2. Press **Details**, scroll to the desired phone number, press **Options**, and select *Add voice tag*
3. Press **Start**, and speak clearly the word(s) that you want to record as a voice tag. After recording, the phone plays the recorded tag.
 appears after the phone number with a voice tag in *Contacts*.

Making a call by using a voice tag

If the phone has an application running that is sending or receiving data using the (E)GPRS connection, you must end the application before using voice tags.

1. In standby mode, press and hold the volume-down key or the right selection key . A short tone sounds, and *Speak now* is displayed.
2. Speak the voice tag clearly. The phone plays the recognised voice tag, and dials the phone number of the voice tag after 1.5 seconds.

If you are using a compatible headset with the headset key, press and hold the headset key to start the voice dialing.

Other functions in the Contacts

Press **Menu**, and select *Contacts*, and select from the following:

- *Speed dials* to assign a number to a speed-dialing key. Scroll to the speed-dialing key number that you want, press **Assign**, or if a number has already been assigned to the key, press **Options**, and select *Change*. Press **Search**, and select first the name, then the number that you want to assign.

See also *Speed dialling* in **Call settings** on page 96, and *Speed dialing* on page 37.

- *Voice tags* to listen to, delete, or change the saved voice tags.
- *Info numbers* or *Service numbers* (network services) are numbers that your service provider may have included in your SIM card.
- *My numbers* to view the numbers assigned to your SIM card if this is allowed by the card.

- *Caller groups* to arrange the names and phone numbers saved in *Contacts* into caller groups. For each caller group, you can set, for example, the phone to sound a specific ringing tone, and show a selected graphic on the display when you receive a call from a phone number in the group. To set the phone to ring only upon calls from phone numbers belonging to a selected caller group, see *Alert for* in *Tone settings* on page 90.

■ Call register



The phone registers the phone numbers of missed, received and dialled voice calls and push to talk addresses of one-to-one push to talk calls, and the approximate length of your calls.

The phone registers missed and received calls only if the network supports these functions, and the phone is switched on and within the network service area.

When you press *Options* in the *Missed calls*, *Received calls* and *Dialled numbers* menu, you can, for example, view the date and the time of the call, edit or delete the phone number from the list, save the number in *Contacts*, or send a message to the number.

Recent calls lists

Press *Menu*, and select *Call register* and then select from the following:

- *Missed calls* to view the list of the latest phone numbers from which somebody has unsuccessfully tried to call you (network service).

- *Received calls* to view the list of the latest phone numbers from which you have most recently accepted calls (network service).
- *Dialled numbers* to view the list of the phone numbers that you have most recently called or attempted to call.
- *Delete recent call lists* to delete the recent calls lists.

Call counters and call timers



Note: The actual invoice for calls and services from your service provider may vary, depending upon network features, rounding-off for billing, taxes and so forth.

Press **Menu**, and select *Call register* and select from the following:

- *Call duration*. Scroll to view the approximate duration of your incoming and outgoing calls in hours, minutes, and seconds.
- *GPRS data counter*. Scroll to check the approximate amounts of data that were sent or received in the last session, data sent and received in total, and to clear the counters.
- *GPRS connection timer*. Scroll to check the approximate duration of the last GPRS connection or the total GPRS connection time.

Message counter

To view how many text, instant messaging and multimedia messages you have sent and received, press **Menu**, and select *Call register*, *Message counter* and *Sent messages* or *Received messages*. To clear the counters, select *Clear counters*.

Positioning

The network may send you a location request. You can ensure that the network will deliver location information of your phone only if you approve it (network service). Contact your network operator or service provider to subscribe and to agree upon the delivery of location information.

- To accept or reject the location request, press **Accept** or **Reject**. If you miss the request, the phone automatically accepts or rejects it according to what you have agreed with your network operator or service provider. The phone displays *1 missed position request*. To view the missed location request, press **Show**.

To view the information on the 10 most recent privacy notifications and requests or to delete them, press **Menu**, and select *Call register*, *Positioning*, *Position log*, and *Open folder* or *Delete all*.

■ Settings



Profiles

You can customize tones with preset profiles for different events, environments, or caller groups.

Press **Menu**, and select *Settings*, and *Profiles*. Scroll to a profile and press **Select**.

- To activate the selected profile, select *Activate*.
- To set the profile to be active for a certain amount of time up to 24 hours, select *Timed*, and set the end time. When the time set for the profile expires, the previous profile that was not timed becomes active.

- To personalise the profile, select *Personalise*. You can change the same settings also in the *Tone settings* menu. See *Tone settings* on page 90.

To change your presence status information, select *My presence*. This menu is available if you have set *Synchronise with profiles* to *On*. See *Presence-enhanced contacts - My presence* on page 80.

To rename a profile, select *Profile name*. The *General* profile cannot be renamed.

Themes

A theme contains many elements for personalising your phone, such as wallpaper, screen saver, color scheme and a ringing tone.

Press **Menu**, and select *Settings*, and *Themes*. Select from following:

- *Select theme* to open the list of folders in the *Gallery*. To set a theme in your phone, open the *Themes* folder, and select a theme.
- *Theme downloads* to open a list of downloads links to download more themes. Refer to *Downloading* on page 138.

Tone settings

Press **Menu**, and select *Settings* and *Tone settings*. You can find the same settings in the *Profiles* menu. The settings you make also change the settings in the active profile.

You can select, for example, how the phone notifies you of an incoming voice call, select the ringing tone for incoming calls and messages, set the push to talk

notification tones and voice status, set the ringing volume, and select the phone to ring only for call from phone numbers that belong to a selected caller group.

Main display settings

Press **Menu**, and select *Settings* and *Main display settings*. You can change the following settings:

- *Wallpaper* to add the background image to the main display in standby mode. To select, activate, or deactivate the wallpaper, select *Select wallpaper, On* or *Off*. Select *Select slide set* and a folder in the *Gallery* to use the images in the folder as a slide set.
To download more images for wallpaper, select *Graphic downloads*.
- *Colour schemes* to change the color in some display components, for example, menu background color and signal and battery bar colors.
- *Operator logo* to set your phone to display or hide the operator logo. If you have not saved the operator logo, the *Operator logo* menu is dimmed.
For more information on availability of an operator logo, contact your network operator or service provider.
- *Menu view* to set the way the phone displays the main menu. Select *List* or *Grid*.

Mini display settings

Press **Menu**, and select *Settings* and *Mini display settings*. You can change the following settings:

- *Wallpaper* to add the background image to your phone mini display in standby mode. The wallpaper is not displayed when the phone activates the screen saver.
To download more images for wallpaper, select *Graphic downloads*.
- *Colour schemes* to change the color in some display components, for example, menu background color and signal and battery bars.
- *Screen saver* to activate the screen saver for the mini display, select *On*. To set the time after which the screen saver on the mini display is activated, select *Time-out*. To select a graphic for the screen saver, select *Select s. saver*, and open *Graphics, Scr. savers*. To download more images for screen saver, select *Graphic downloads*.

Time and date settings

Press *Menu*, and select *Settings* and *Time and date settings*. Select *Clock* and *Date* to make time and date settings and to select if the time and date are shown on the display in standby mode. Select *Auto-update of date & time* (network service) to set the phone to automatically update the time and date according to the current time zone. Auto-updating may cause some alarms you have set to expire.

If the battery is removed from the phone for a long time or if the battery is discharged, you may need to set the time again.

Personal shortcuts

To select a function for the right selection key and add voice commands for some functions, press **Menu**, and select *Settings*, and *Personal shortcuts*.

- Select *Right selection key* to set a function for the right selection key. Scroll to a function and select it.
- Select *Voice commands* and a command folder. Select the function to which you want to add a voice command, and press **Add**. You can add voice commands for a certain numbers of functions.

To add a voice command, refer to [Adding and managing voice tags](#) on page 85.

To activate a voice command, refer to [Making a call by using a voice tag](#) on page 86.

During a call, or when an application using the (E)GPRS connection is sending or receiving data, you cannot activate or add a voice command.

Connectivity

Infrared

Do not point the IR (infrared) beam at anyone's eye or allow it to interfere with other IR devices. This device is a Class 1 laser product.

You can set up the phone to send and receive data through its infrared (IR) port. You can send or receive data (such as business cards) to or from a compatible phone or data device (such as a computer) using the IR port of your phone.

To use an IR connection, the compatible device with which you want to establish a connection must be IrDA compliant.

When sending or receiving data using IR, ensure that the IR ports of the sending and receiving devices are pointing at each other and that there are no obstructions between the devices. The preferable distance between the two devices in an infrared connection is 1 meter (3.28 feet) at most.

To activate the IR port of your phone to receive data using IR, press **Menu**, and select *Settings, Connectivity, and Infrared*.

To deactivate the IR connection, press **Menu**, and select *Settings, Connectivity, and Infrared*. Press **Yes** when the phone displays *Deactivate infrared?*

If data transfer is not started within 2 minutes after the activation of the IR port, the connection is canceled and must be restarted.

GPRS

General Packet Radio Service (GPRS) is a network service that allows mobile phones to be used for sending and receiving data over an Internet Protocol (IP) - based network. GPRS is a data bearer that enables wireless access to data networks such as the Internet.

Enhanced GPRS (EGPRS) uses enhanced data rates for global evolution (EDGE), a radio interface modulation technique, to increase the data rates of GPRS.

The functions of your phone that may use (E)GPRS are messaging, browsing pages, e-mail application, remote synchronisation, push to talk, application downloading, and the PC dial-up (for example, Internet and e-mail).

Before you can use (E)GPRS technology:

- Contact your network operator or service provider to check availability, to subscribe to the (E)GPRS service, and to obtain information on data transfer speed and pricing.
- Save the (E)GPRS settings for each application that uses (E)GPRS.

When you have selected GPRS as a data bearer, the phone uses EGPRS instead of GPRS if this is available in the network. You cannot select between EGPRS and GPRS, but for some applications you may be able to select either GPRS or *GSM data* (CSD, Circuit Switched Data).

GPRS connection

To define the settings for (E)GPRS connections, press **Menu**, and select *Settings, Connectivity, GPRS*, and *GPRS connection*.

- Select *Always online* to set the phone to automatically register to an (E)GPRS network when you switch the phone on.

When you start an application using (E)GPRS, the connection between the phone and network is established. When you exit the application, the (E)GPRS connection ends, but the phone is still registered to the (E)GPRS network.

If you receive a call or a text message or make a call during an (E)GPRS connection, the (E)GPRS connection is suspended (on hold).

The indicator for GPRS and (E)GPRS is the same.

- Select *When needed* to set the phone to register to an (E)GPRS network and establish an (E)GPRS connection when an application using (E)GPRS requires it. The (E)GPRS connection will close when you exit the application.

The phone supports three simultaneous (E)GPRS connections. For example, you can browse XHTML pages, receive multimedia messages, and have an ongoing PC dial-up connection at the same time.

GPRS modem settings

You can connect the phone with an infrared or a data cable connection to a compatible PC, and use the phone as a modem to enable (E)GPRS connection from the PC.

To define the settings for (E)GPRS connections from the PC, press **Menu**, and select *Settings*, *Connectivity*, *GPRS* and *GPRS modem settings*.



- Select *Active access point* to activate the access point that you want.
- Select *Edit active access point* to change the access point settings. Contact your network operator or service provider for the access point name.

You can also set the (E)GPRS dial-up service settings (access point name) on the PC using the Nokia Modem Options software. If you have set the settings both on the PC and on the phone, the PC settings will be used.

Call settings

Press **Menu**, and select *Settings* and *Call settings*. Select from the following settings:

- *Call divert* (network service) to direct your incoming calls to another number, for example, to your voice mailbox (network service). For details, contact your service provider.

- *Anykey answer*, select *On*, and you can answer an incoming call by briefly pressing any key except the power key, the push to talk key, the selection keys  and , and .
- *Answer when fold is opened* to select whether opening the fold automatically answers an incoming call.
- *Automatic redial* to set the phone to make a maximum of 10 more attempts to connect the call after an unsuccessful call attempt.
- *Speed dialling* to set the phone to dial the phone numbers assigned to the speed-dialling keys, from **2**_{ABC} to **9**_{WXYZ}, by pressing and holding the corresponding number key.
- *Call waiting* to request the network to notify you of an incoming call while you have a call in progress (network service).
- *Summary after call* to set the phone to briefly display the approximate duration and cost (network service) of the call after each call.
- *Send my caller ID* to set the phone to show your phone number to the person you are calling (network service). Select *Set by network*, and the setting agreed upon with your service provider is used.
- *Line for outgoing calls* (network service) to select phone lines 1 or 2, for making calls. For more information on availability, contact your network operator or service provider.

If you select *Line 2* and have not subscribed to this network service, you are not able to make calls. However, calls on both lines can be answered regardless of the selected line.

Phone settings

Press **Menu**, and select *Settings* and *Phone settings*. Select from the following settings:

- *Language settings*, and to set the language for the display texts, select *Phone language*. If *Automatic* is selected, the phone selects the language according to the information on the SIM card.
To use another language for writing text, select *Writing language*. You can also temporarily change the language for writing text. See [Writing text](#) on page 41.
- *Memory status* to view the amount of free and used memory for each function in the list.
- *Security keyguard* to set the phone to ask for the security code when you unlock the keyguard.

When the keyguard is on, calls still may be possible to the official emergency number programmed into your device. Key in the emergency number and press the call key .

- *Cell info display* to set the phone to indicate when you use it in a cellular network based on Micro Cellular Network (MCN) technology (network service).
- *Welcome note* to key in and save a personal note that is shown briefly when you switch on the phone.
- *Operator selection* to set the phone automatically select one of the cellular networks available in your area.

If you select *Manual*, you can select a network that has a roaming agreement with your home service provider. The phone stays in manual mode until automatic mode is selected or another SIM card is inserted into the phone.

- *Confirm SIM service actions* to confirm messages sent between your phone and your service provider.
Accessing these services may involve sending a text message or making a phone call. You may be charged for these services.
- *Help text activation* to set the phone to show the help texts. See [Using the menu](#) on page 45.
- *Start-up tone* to set the phone to play a start-up tone when the phone is switched on.

Enhancement settings

The enhancement settings menu is shown only if the phone has been or is currently connected to a compatible mobile enhancement, such as the handsfree unit.

Press **Menu**, and select *Settings* and *Enhancement settings*. You can select an enhancement menu if the corresponding enhancement is or has been connected to the phone. Depending on the enhancement, you can select options, for example, a profile that can be activated automatically when you connect the enhancement.

Configuration settings

You can configure your phone with settings that are required for certain services to function correctly. The supported services are multimedia messaging, instant messaging, synchronisation, e-mail application, streaming, push to talk, and

browser. Your service provider may also send you these settings. See [Configuration settings service](#) on page 18.

For information on availability and the appropriate configuration settings, contact your network operator or service provider.

Press **Menu**, and select **Settings**, and **Configuration settings**. Select from the following list:

- **Default configuration sett.**, and the list of service providers saved in the phone is shown. Scroll to a service provider, and press **Details** to view the applications that the configuration settings of this service provider supports.

Press **Options**, and select **Set as default** to set the configuration settings of the service provider as default settings. To delete configuration settings, select **Delete**.

- **Activate default in all applications** to activate the default configuration settings for supported applications.
- **Preferred access point** includes names of the saved access points. Scroll to an access point, press **Options**, and select **Details** to view the name of the service provider, data bearer, and GPRS access point or GSM dial-up number.
- **Personal configuration settings** to add new personal accounts for various services, and to activate or delete them.

To add new personal account if you have not added any, press **Add new**; otherwise, press **Options**, and select **Add new**. Select the service type, and one by one select and key in all the required parameters. The parameters differ according to the selected service type.

To delete or activate a personal account, scroll to it, press **Options**, and select *Delete* or *Activate*.

Security settings

When security features that restrict calls are in use (such as call barring, closed user group and fixed dialing) calls still may be possible to the official emergency number programmed into your device.

Security settings contains settings for access codes and other security features.

Press **Menu**, and select *Settings* and *Security settings*. Select from the following settings:

- *PIN code request* to set the phone to request your PIN code every time the phone is switched on. Some SIM cards do not allow the PIN code request to be turned off.
- *Call barring service* (network service) to restrict calls
- *Fixed dialling* to restrict your outgoing calls and text messages to selected phone numbers if this function is supported by your SIM card.

When fixed dialing is on, (E)GPRS connections are not possible except while sending text messages over a (E)GPRS connection. In this case, the recipient's phone number and the message centre number must be included on the fixed dialing list.

- *Closed user group* (network service) to specify the group of people whom you can call and who can call you. For more information contact your network operator or service provider.

- **Security level.** Enter the security code, and select **Phone** to set the phone to ask for the security code whenever a new SIM card is inserted into the phone.
Select **Memory** to set the phone to ask for the security code when the SIM card memory is selected, when you change the memory in use, or copy from one memory to another (**Copying contacts** on page 83).
- **Access codes** to change the security code, PIN code, PIN2 code, or barring password.

Restore factory settings

To reset some of the menu settings to their original values, press **Menu**, and select **Settings** and **Restore factory settings**. Key in the security code and press **OK**.

The data that you have keyed in or downloaded is not deleted, for example, the names and phone numbers saved in **Contacts**.

■ Gallery

You can save images and ringing tones that, for example, have been received in multimedia messages in the folders of the gallery.



The phone supports the following file formats:

- Picture: JPEG, GIF, WBMP, BMP, OTA-BMP, and PNG
- Sound: scalable polyphonic MIDI (SP-MIDI), MP3, AAC AMR, and monophonic ringing tones
- Video clip: 3GP format (H.263 baseline and MPEG-4 simple profile)

The phone may not support all variations of the file formats.

Your phone supports a Digital Rights Management (DRM) system to protect acquired content. A piece of content, for example a ringing tone, can be protected and associated with certain usage rules, for example the number of usage times and a certain usage period. The rules are defined in the content's activation key which can be delivered either together with the content or independently depending on the service provider. You may be able to update these activation keys. Always check the delivery terms of any content and activation key before acquiring them, as they may be subject to a fee.

Copyright protections may prevent some images, ringing tones, and other content from being copied, modified, transferred or forwarded.

1. Press **Menu**, and select *Gallery*.
2. Scroll to the desired folder, and press **Open** to view the files in the folder, or press **Options** to select an option for the folder:
 - *Add folder, Delete folder, Move, Rename folder, Details, Type of view, or Sort*. You cannot delete, rename, or move the original folders on the phone.
 - *Downloads* to download more images and tones.
To check the availability of different services, pricing, and tariffs, contact your network operator or service provider. Download content only from sources you trust.
 - *Memory status* to view the memory consumption information of the phone.
 - *Activation key list* to view the list of all available activation keys. You can delete the expired activation keys, for example.

3. If you opened a folder, scroll to the desired file.

To view the file, press **Open**, or to send the file using MMS, press the call key . The phone can play video clips in 3GP format (H.263 baseline and MPEG-4 simple profile), and short MP3 and AAC audio clips.

Press **Options** and select the option that you want from the list.

■ Media



Camera

You can take photos or record video clips with the built-in camera. The camera lens is on the fold of the phone, and the main or mini display of the phone works as a viewfinder. The camera produces images in JPEG format and the video clips in H.263 (SubQCIF) format.

If there is not enough memory to take a new photo, you need to free some by deleting old photos or other files in the gallery.

Taking a photo

1. To open the camera viewfinder, press **Menu**, and select *Media*, and *Camera*.
To open the viewfinder options, press **Options**, and you can, for example, select to change the operation mode, zoom the image, and access the gallery or the camera settings. For one photo at a time you can also activate the self-timer or select to use the mini display as the viewfinder.
2. To take a photo, press **Capture**. The phone saves the photo in the *Images* folder of the *Gallery* menu.

3. Press **Back** to take another photo, or **Send** the photo. Press **Options**, and select from the list of options.

Recording a video clip

1. Press **Menu**, and select *Media*, and *Camera*. Press **Options**, and select *Change mode* and *Video*.
2. To start recording a video clip, press **Record**. To pause the recording, press **Pause**, and to resume the recording, press **Continue**.
3. To stop the recording, press **Stop**. The phone saves the recording in the *Video clips* folder of the *Gallery* menu.

Press **Play** to view the recording, or press **Options**, and select, for example, an option to delete or rename the saved video clip, send it as a multimedia message or using an IR connection, or access the gallery.

Camera settings

Press **Menu**, and select *Media*, and *Camera*. Press **Options**, and select *Settings* and an option from the list. You can define the image quality, set the length of the video clips, the camera sounds, and default title and default mode.

Media player

With the media player you can view, play, and download files, for example images, audio, video, and animated images from different kinds of sources. In addition it allows you to see compatible streaming videos from a network server (network service).

Press **Menu**, and select *Media* and *Media player*. Select *Open gallery*, *Bookmarks*, *Go to address*, or *Media downloads*.

Setting up the phone for a streaming service

You may receive the configuration settings required for the streaming as a configuration message from the network operator or service provider. See [Configuration settings service](#) on page 18.

To key in the settings manually, see [Configuration settings](#) on page 99.

Press **Menu**, and select *Media*, *Media player* and *Streaming sett.*.

- Select *Configuration*. Only the configurations that support streaming are shown. Select a service provider, *Default*, or *Personal config*. for streaming. You may receive the streaming settings as a configuration message, see [Configuration settings service](#) on page 18. To key in the configuration settings manually, see [Configuration settings](#) on page 99.
- Select *Account* and a streaming service account contained in the active configuration settings.

Radio

The FM radio uses the wire of the headset as an antenna. A compatible headset needs to be attached to the device for the FM radio to function properly.



Warning: Listen to music at a moderate level. Continuous exposure to high volume may damage your hearing.

The quality of the radio broadcast depends on the radio station's coverage in that particular area.

1. To turn on the radio, press **Menu**, and select **Media** and **Radio**.
2. If you have saved radio channels, scroll to the channel you want to listen to, or select a radio channel location 1 to 9 by pressing the corresponding number key.

When using the compatible headset supplied with the headset key, press the key to scroll to the desired saved radio channel.

3. To turn off the radio, press **Options**, and select **Switch off**, or press and hold .

You can close the fold of the phone while listening to the radio.

You can make a call or answer an incoming call normally while listening to the radio. The volume of the radio is muted. When you end the call, the radio volume will automatically be turned up again.

When an application using a (E)GPRS or HSCSD connection is sending or receiving data, it may interfere with the radio.

Tuning a radio channel

When the radio is on, press and hold the scroll key down or up to start the channel search. Searching stops when a channel is found. To save the channel, press **Save**, or press **Options**, and select **Save channel**. Key in the name of the channel, and press **OK**. Select the location where you want to save the channel.

Using the loudspeaker



Warning: Do not hold the device near your ear when the loudspeaker is in use, because the volume may be extremely loud.

When the radio is on, press **Options**, and select *Loudspeaker* to listen to the radio using the loudspeaker. Keep the headset connected to the phone.

Voice recorder

You can record speech, sound, or an active call for up to 3 minutes. You can also set a recording as a ringing tone.

The recorder cannot be used when a data call or GPRS connection is active.

Recording

1. Press **Menu**, select *Media* and *Voice recorder*.
2. To start the recording, select *Record*. To start recording a call, press **Options**, and select *Record*. While recording a call, hold the phone in the normal position near to your ear. All parties to the call will hear a faint beep approximately every 5 seconds.
3. To end the recording, press **Stop**. The recording will be saved in the *Recordings* folder of the *Gallery* menu.

To open the list of the saved recordings, select *Recordings list*. Open the *Recordings* folder and the recording that you want to listen to.

To listen to the latest recording, select *Play last recorded*.

To send the latest recording using multimedia messaging or infrared, select *Send last recorded*.

■ Push to talk



Push to talk over cellular (PTT) is a two-way radio service available over a GSM/GPRS cellular network (network service). Push to talk provides direct voice communication connected with the push of the PTT key.

You can use push to talk to have a conversation with one person or with a group of people having compatible devices. When your call is connected, the person or group you are calling does not have to answer the phone. Besides the GPRS counters, the phone registers only one-to-one calls in the recent call lists in *Call register*. The participants should confirm the reception of any communications where appropriate as there is no other confirmation whether the recipient(s) have heard the call.

To check availability and costs, and to subscribe to the service, contact your network operator or service provider. Roaming services may be more limited than for normal calls.

Before you can use the push to talk service, you must define the required push to talk service settings.



While you are connected to the push to talk service, you can use the other functions of the phone. The push to talk over cellular service is not connected to traditional voice communication, and therefore many of the services available for traditional voice calls (for example, voice mailbox) are not available for push to talk over cellular communications.

Opening the push to talk menu

Press **Menu**, and select *Push to talk*.

- To connect to or disconnect from the push to talk service, select *Switch PTT on* or *Switch PTT off*.
- To view the received callback requests, select *Callback inbox*.
- To view the list of push to talk groups, select *Group list*.
- To view the list of contacts to which you have added the push to talk address, select *Contacts list*.
- To add a new push to talk group to the phone, select *Add group*.
- To set the push to talk settings for use, select *PTT settings*.
- To set the required settings for the push to talk connection, select *Configuration settings*.
- To open the browser and to connect to the push to talk network portal provided by the service provider, select *Services*.

Connecting to and disconnecting from the push to talk service

To connect to the push to talk service, press **Menu**, and select *Push to talk*, and *Switch PTT on*.  indicates the push to talk connection.  indicates that the service is temporarily unavailable. The phone automatically tries to reconnect to the service until you disconnect from the push to talk service. If you have added group(s) to the phone, you are automatically joined to the active (*Default* or *Listened*) groups, and the name of the default group is displayed in standby mode.

To disconnect from the push to talk service, select *Switch PTT off*.

Callback requests

If you make a one-to-one call and do not get a response, you can send a request for the person to call you back.

When someone sends you a callback request, *Callback request received* is displayed in standby mode. When you receive a callback request from someone who is not in your contacts list, you can save the name to your contacts.

Sending a callback request

- To send a callback request from the contacts list in the *Push to talk* menu, select *Contacts list*. Scroll to a contact, press **Options**, and select *Send callback*.
- To send a callback request from the *Contacts*, press the scroll key down in standby mode, and scroll to the desired contact. Press **Details**, scroll to the push to talk address, press **Options**, and select *Send callback*.
- To send a callback request from the group list in the *Push to talk* menu, select *Group list*, and scroll to the desired group. Press **Options**, select *Active members*, scroll to the desired contact, press **Options**, and select *Send callback*.
- To send a callback request from the callback request list in the *Push to talk* menu, select *Callback inbox*. Scroll to a contact, press **Options**, and select *Send callback*.

Responding to a callback request

1. To open the *Callback inbox*, press **View**. The list of nicknames of the persons who have sent you callback requests is shown.
2. To make a one-to-one call, press the PTT key.
3. To send a call request back to the sender, press **Options**, and select *Send callback*.
To delete the request, press **Delete**.

Saving the callback request sender

1. To open the *Callback inbox*, press **View**. The list of nicknames of the persons who have sent you callback requests is shown.
2. To view the sender's push to talk address, press **Options**, and select *View PTT address*.
To save a new contact or to add the push to talk address to a contact, press **Options**, and select *Save as* or *Add to contact*.

Making and receiving a push to talk call

Set the phone to use either loudspeaker or earpiece for push to talk communication. When the earpiece is selected, you can use the phone normally to your ear.



Warning: Do not hold the device near your ear when the loudspeaker is in use, because the volume may be extremely loud.

When connected to the push to talk service, you can make or receive group calls or one-to-one calls. One-to-one calls are calls you make to only one person, instead of a group.

Making a group call

To make a call to the default group, press the PTT key. A tone sounds indicating that the access is granted, and the phone displays your nickname and group name.

To make a call to a nondefault group, select *Group list* in the push to talk menu, scroll to the desired group, and press the PTT key.

Press and hold the PTT key the entire time you are talking, and hold the phone in front of you so that you can see the display. When you have finished, release the PTT key. Talking is allowed on a first-come, first-served basis. When someone stops talking, the first person to press the PTT key can talk next.

Making a one-to-one call

- To start a one-to-one call from the list of contacts to which you have added the push to talk address received from the service provider, select *Contacts list*. Scroll to a contact, and press the PTT key.

You can also select the contact from the *Contacts list*.

- To start a one-to-one call from the list of push to talk groups, select *Group list*, and scroll to the desired group. Press *Options*, select *Active members*, scroll to the desired contact, and press the PTT key.
- To start a one-to-one call from the list of callback requests you have received, select *Callback inbox*. Scroll to the desired nickname, and press the PTT key.

Receiving a group or a one-to-one call

A short tone notifies you of an incoming group and one-to-one call. When receiving a group call, the group name and the nickname of the caller are displayed. When receiving a one-to-one call from a person whose information you have saved in *Contacts*, the saved name is displayed if identified; otherwise, only the nickname of the caller is displayed.

You can either accept or reject an incoming one-to-one call if you have set the phone to first notify you of the one-to-one calls.

If you press the PTT key to try to respond to a group while another member is talking, you hear a queuing tone and *Queuing* is displayed as long as you press the PTT key. Press and hold the PTT key, and wait for the other person to finish, then you can talk.

Adding one-to-one contact

You can save the names of persons to whom you often make one-to-one calls.

- To add a push to talk address to a name in the *Contacts*:
Press the scroll key down in standby mode, scroll to the desired contact, and press **Details**. Press **Options** and select *Add detail* and *PTT address*.
- To add a contact to the push to talk contacts list:
To add the push to talk contact, open the push to talk menu, and select *Contacts list*. Press **Options**, and select *Add contact*.
- To add a contact from the group list:

When connected to the push to talk service, select *Group list*, scroll to the desired group, and press **Options**. Select *Active members*, scroll to the member whose contact information you want to save, and press **Options**. Select *Save as* to add a new contact, or *Add to contact* to add a push to talk address to a name in the *Contacts*.

Creating and setting up groups

When you call a group, all members joined to the group hear the call simultaneously.

Each member in the groups is identified by a nickname, which is shown as a caller identification. Group members can choose a nickname for themselves in each group.

Groups are registered with a URL address. One user registers the group URL in the network by joining the group session the first time.

There are three types of push to talk groups:

- Provisioned groups are closed groups that allow only selected participants provisioned by the service provider to join in the groups.
- Ad hoc groups are groups that the users can create. You can create your own group, and invite members to the group.
- Ad hoc pro groups are groups you can create from members in a provisioned group. For example, a business can have a closed group, plus separate groups created for certain business functions.

Adding a group

1. Press **Menu**, and select *Push to talk*, *Add group*, and *Guided*.
2. To set the security level for the group, select *Open group* or *Secured group*.
If you select *Secured group*, the phone automatically creates a scrambled part to the group address that the members cannot view when they receive the invitation to the group. Only the person who creates the secured group, can invite more members to the group.
3. Key in the name for the group, and press **OK**.
4. Select the status for the group: *Default*, *Listened*, or *Inactive*. The phone indicates that the group is saved and its status. *Default* and *Listened* are active groups. When you press the PTT key to make a group call, the default group is called if you have not scrolled to any other group or contact.
5. To send an invitation to the group, press **Yes** when the phone requests for sending an invitation. You can send the invitation using a text message or infrared.
The members you invite to the open groups can also invite more members to the group.

Receiving an invitation

1. When you receive a text message invitation to a group, *Group invitation received*: is displayed.
2. To view the nickname of the person who sent the invitation and the group address if the group is not a secured group, press **View**.

3. To add the group to your phone, press **Save**, and to set the status for the group, select *Default*, *Listened*, or *Inactive*.

To reject the invitation, press **Exit** and **Yes**, or press **View**, **Discard**, and **Yes**.

Settings for push to talk

There are two kinds of push to talk settings: settings for use and for connecting to the service.

You may receive the settings for connecting to the service as a configuration message from your network operator or service provider, see [Configuration settings service](#) on page 18. To key in the settings manually, see [Configuration settings](#) on page 99.

To access the settings for connecting to the service, press **Menu**, and select *Push to talk*, and *Configuration settings*. Select from following:

- *Configuration*. Only the configurations that support the push to talk service are shown. Select a service provider, or *Default*, or *Personal config*. for push to talk service. You may receive the push to talk settings as a configuration message, see [Configuration settings service](#) on page 18. To key in the configuration settings manually, see [Configuration settings](#) on page 99.
- *Account* and select a push to talk service account contained in the active configuration settings.

- Select one by one to set the following: *PTT user name*, *Default nickname*, *PTT password*, *Domain*, and *Server address*.

To access the push to talk settings for use, press **Menu**, and select *Push to talk*, and *PTT settings*. Select from following:

- *1 to 1 calls* and *On* to select the phone to allow the reception of incoming one-to-one calls. If you select *Off*, you can make but not receive one-to-one calls. The service provider may offer some services that override these settings.
1 to 1 calls and *Notify* to set the phone to first notify you of incoming one-to-one calls with a ringing tone.
- *Listened groups* and *On* to activate the listened groups.
- *PTT status in startup* and *Yes* to set the phone to automatically connect to the push to talk service when you switch the phone on.
- *Send my PTT address* and *No* to hide your push to talk address from group and one-to-one calls.

■ **Organiser**



Alarm clock

The alarm clock works if you close the fold or even when the phone is switched off if there is enough power in the battery.

Press **Menu**, and select *Organiser* and *Alarm clock*.

- Select *Alarm time*, and if the alarm time is not set, key in the alarm time, and press **OK**. Otherwise, to change the alarm time, select *On*.
- Select *Repeat alarm* and *Repetition days*. Mark the days when you want the alarm to be repeated, and press **Done**.
- Select *Alarm tone* to set a tone for the alarm.

To select the radio as an alarm tone, connect the headset to the phone. The channel most recently selected is the alarm tone. The radio alarm is played through the loudspeaker even though the headset is connected. If the headset is removed, the default alarm tone replaces the radio.

When the alarm time expires

If the alarm time is reached while the device is switched off, the device switches itself on and starts sounding the alarm tone. If you press **Stop**, the device asks whether you want to activate the device for calls. Press **No** to switch off the device or **Yes** to make and receive calls. Do not press **Yes** when wireless phone use may cause interference or danger.

When the alarm time is reached while the phone is switched on, the phone sounds an alert tone, flashes *Alarm!*, and shows the current time. To turn off the alarm, press **Stop**. To stop the alarm for 10 minutes, press **Snooze** or any key except **Stop**.

When the fold is closed, press either of the volume keys to switch the alarm clock to snooze.

Calendar



You can track appointments, meetings, birthdays, anniversaries, and other events, and set a calendar alarm as a reminder.

Press **Menu**, and select *Organiser* and *Calendar*. Scroll to the day that you want. The current day is indicated by a frame around it. If any notes are set for the day, the day is shown in bold.

- If you press **View**, you can view the day notes.
 - To view a single note, scroll to the note that you want to view, and press **View**. The note view allows you to view the details of the selected note. You can scroll through the note. When you have set the alarm for the note, the indicator  is displayed.
 - Press **Options** and there are, for example, options for making a note, or for sending a note using IR, or as a note directly to another compatible phone calendar, or as a text or multimedia message.

Settings to set, for example, the date, time, date or time format, or the first day of the week. In the *Auto-delete* option you can set the phone to delete old notes automatically after a specified time. However, the repeated notes, for example, birthday notes, will not be deleted.
- If you press **Options**, you can select *Week view* to view a week. There are also, for example, options for making a note, accessing the to-do list, or deleting all notes in calendar, or selecting settings.

Note alarm

The phone beeps, and displays the note. With a call note  on the display, you can call the displayed number by pressing the call key .

- To stop the alarm and to view the note, press **View**. Press **Snooze** and the phone returns to standby mode.
- To stop the alarm without viewing the note, press **Exit**.

When the fold is closed, press either of the volume keys to mute the note alarm.

To-do list

You can save a note for a task, select a priority level for the note, and mark it as done when you have completed the task. You can sort the notes by priority or by date.

Press **Menu**, and select *Organiser* and *To-do list*.

To add a new note when the note list is empty, press **Add note**, or if you have saved notes, press **Options**, and select *Add*. Key in the note and press **Save**. Select the priority for the note. The phone automatically sets the deadline without an alarm for the note. To change the deadline, view the note and select the option for deadline.

Notes

You can write and send notes to compatible devices with infrared, text messaging, or multimedia messaging.

To access *Notes*, press **Menu**, and select *Organiser* and *Notes*. To add a note if the list of notes is empty, press **Add note**. Otherwise, press **Options**, and select *Make a note*. Key in the note and press **Save**.

- To view a note, scroll to it, and press **View**.
To edit the note, press **Edit**. While editing a note, press **Options** and you can select, for example, to add date and time to the note. Select **Close** to exit the text editor without saving the changes.
- Press **Options**, and you can, for example, send the note to a compatible device using IR or as a text or multimedia message. If the note is too long to be sent as a message, the phone will ask you to delete the appropriate number of characters from your note.

Synchronisation

Synchronisation allows you to save your calendar and contacts data on a remote Internet server (network service) or on a compatible PC. If you have saved data on the remote Internet server, you can synchronise your phone by starting the synchronisation from the phone. Synchronising to the remote server is a network service. You can also synchronise the data in your phone contacts and calendar to correspond with the data of a compatible PC by starting the synchronisation from the PC. The contact data in your SIM card will not be synchronised.

Answering an incoming call during synchronisation will end the synchronisation and you must restart it.

Synchronising from your phone

Before synchronising from your phone, you may need to do the following:

- Subscribe to a synchronisation service. For more information on availability and the synchronisation service settings, contact your network operator or service provider.
- Retrieve the synchronisation settings from your network operator or service provider, see [Settings for synchronisation](#) on page 123.

To start the synchronisation from the phone:

1. Select the configuration settings you need for the synchronisation. See [Settings for synchronisation](#) on page 123.
2. Press **Menu**, select *Organiser*, *Synchronisation*, *Server sync*, and *Data to be synchronised*. Mark the data to be synchronised.
3. Press **Menu**, and select *Organiser*, *Synchronisation*, *Server sync*, and *Synchronise*. The marked data of the active set will be synchronised after confirmation.

Synchronising for the first time or after an interrupted synchronisation may take up to 30 minutes to complete if the contacts or calendar are full.

Settings for synchronisation

You may receive the configuration settings required for synchronisation as a configuration message from the network operator or service provider. To manage all the configuration settings, see [Configuration settings](#) on page 99.

1. Press **Menu**, select *Organiser*, and *Synchronisation*.

2. Select *Server sync*, and *Sync settings*.
 - Select *Configuration*. Only the configurations that support the synchronisation are shown. Select a service provider, *Default*, or *Personal config*. for synchronisation. You may receive the synchronisation settings as a configuration message, see [Configuration settings service](#) on page 18. To key in the configuration settings manually, see [Configuration settings](#) on page 99.
Select *Account* and a synchronisation service account contained in the active configuration settings.
3. Select *PC sync settings* to key in the settings for server alerted synchronisation. Select to set *User name* and *Password*.
The user name and password have to be the same in the phone and in the PC.

Synchronising from a compatible PC

To synchronise the contacts and calendar from the PC, use an IR connection or a data cable. You also need the PC Suite software of your phone installed on the PC, refer to [PC Connectivity](#) on page 144. Start the synchronisation from the PC using PC suite.

Wallet

In *Wallet* you can save personal information such as credit card numbers, user names, or passwords. You can easily retrieve data and automatically fill in data fields while you are making purchases online.

The data saved in the wallet is protected with a wallet code that you can define when you access wallet for the first time. At *Create wallet code*: key in the code, and press **OK**. At *Verify wallet code*: key in the code again, and press **OK**.

To delete the wallet code and all contents of the wallet, key in *#7370925538# (*#res wallet# in letters) in standby mode. You also need the phone security code.

To add or edit the content of the wallet, access the wallet menu. To use the content of the wallet in a mobile service, access the wallet from the browser, see [Web](#) on page 132.

Accessing the wallet menu

To access the wallet menu, press **Menu**, select *Organiser* and *Wallet*. Key in your wallet code, and press **OK**. Select from the following:

- *Wallet profiles* to create card combinations for different services. You can select the appropriate wallet profile when the service requires you to fill in many data items.
- *Cards* to save personal card information.
- *Tickets* to save the notifications of e-tickets that you have bought. To view the tickets, press **Options**, and select *View*.
- *Receipts* to save receipts of purchases.
- *Personal notes* to save personal information that you want to keep protected by using the wallet PIN code.
- *Settings* to change the wallet code, and set the RFID (radio frequency identification) code.

Saving card details

1. Access the wallet, and select *Cards* and the card type to save details.
2. If no card is added, press **Add new**. Otherwise, press **Options**, and select **Add new**. Fill in the fields with details.

If your service provider supports over the air services, you may receive card information to your phone. The notification tells you to which category the card belongs. Save or discard the received card. You can view and rename the card, but you cannot edit it. For availability of receiving card information over the air, contact the card issuer or service provider.

Personal notes

You can add personal notes to save account numbers, codes, or notations.

Access the wallet, and select *Personal notes*.

- To create a personal note if no note is added, press **Add new**; otherwise, press **Options**, and select **Add new**.
- To view a note, scroll to the desired note, and press **View**.
- To edit the displayed note, press **Options**, and select **Edit**.

While viewing a note, press **Options**. Select *Delete* to delete the note, *Send via text msg.* to copy the note as a text message, and *Copy to calendar* to copy the note to the calendar as a memo. *Use detail* is used to extract numbers, e-mail addresses, and web addresses from a note.

Creating a wallet profile

When you have saved your personal card details, you can combine them into a wallet profile. Use the profile to retrieve wallet data from different cards while browsing.

1. Access the wallet, and select *Wallet profiles*.
2. To create a new wallet profile if no profile is added, press **Add new**; otherwise, press **Options**, and select *Add new*.
3. Select the desired information one by one from the wallet cards, and when *Wallet profile name*: is displayed, enter a name for the new profile.

Wallet settings

Access the wallet, and select *Settings*. Select *Change code* to change the wallet code, and *RFID* to set the RFID code.

Calculator

Press **Menu**, and select *Organiser* and *Calculator*.

When 0 is displayed, key in the first number in the calculation. Press **#** for a decimal point. Alternatively, press ***** **+** repeatedly to add, subtract, multiply, or divide.

For a total, press **Equals**.



Note: This calculator has limited accuracy and is designed for simple calculations.

To start a new calculation, first press and hold **Clear**.

Performing a currency conversion

Press **Menu**, and select *Organiser* and *Calculator*. To save the exchange rate, press **Options**, and select *Exchange rate*. Select either of the displayed options, key in the exchange rate, and press **OK**. The exchange rate remains in the memory until you replace it with another one. Key in the amount to be converted, press **Options**, and select *In domestic* or *In foreign*.

You can also perform the currency conversion in standby mode.





Note: When you change base currency, you must key in the new rates because all previously set exchange rates are set to zero.

Stopwatch

You can measure time and take intermediate times or lap times using the stopwatch. During timing, the other functions of the phone can be used. To set the stopwatch timing in the background, press .

Using the stopwatch or allowing it to run in the background when using other features increases the demand on battery power and reduces the battery life.

Press **Menu**, and select *Organiser* and *Stopwatch*.

- To take intermediate times, select *Split timing*. To start the time observation, press **Start**. Press **Split** every time that you want to take an intermediate time. To stop the time observation, press **Stop**. To set the stopwatch timing in the background, press .
- To take lap times, select *Lap timing*. To set the stopwatch timing in the background, press .

- To view the timing that you have set in the background, select *Continue*.
- To view the most recently measured time if the stopwatch is not reset, select *Show last*.
- To view or delete the saved times, select *View times* or *Delete times*.

Countdown timer

You can set the timer to measure countdown time.

Press **Menu**, and select *Organiser* and *Countdown timer*.

To set the time, key in the alarm time in hours, minutes, and seconds, and press **OK**. If you wish, write a note, which is displayed when the time expires. Press **Start** to start the countdown timer.

To change the countdown time, select *Change time*, or to stop the timer, select *Stop timer*.



Tip: To start the countdown timer or to change the time in standby mode, key in the time in hours, minutes, and seconds, press **Options**, and select *Countdown timer*. If the time is correct, press **Start**.

If the alarm time is reached when the phone is in standby mode, the phone sounds a tone and flashes the note or *Countdown time up*. To stop the alarm, press any key. If no key is pressed, the alarm automatically stops within 30 seconds. To stop the alarm and delete the text note, press **Exit**. To restart the countdown timer, press **Restart**.

When the fold is closed, press either of the volume keys to mute the alarm.

■ Applications



In the *Games* and *Collection* folders you can use and manage the Java games and applications installed in the phone.

Games

Press **Menu**, and select *Applications* and *Games*.

- To select and open a game, scroll to the game, and press **Open** or the call key . For options, press **Options**, and see [Options available for an application](#) on page 131.
- Press **Options**, and to download a game to the phone, select *Downloads* and *Game downloads*. You must have the configuration settings for the browser set in your phone to use the downloading. See [Configuration settings](#) on page 99.
To set sounds, lights, and shakes for the game, select *App. settings*.

Running some games may consume battery power faster (you may need to connect the phone to the charger).

Collection

Press **Menu**, and select *Applications* and *Collection*.

- To select and open an application, scroll to the application, and press **Open** or the call key . For options, press **Options**, and see [Options available for an application](#) on page 131.

- Press **Options**, and to download an application to the phone, select *Downloads* and *App. downloads*. You must have the configuration settings for the browser set in your phone to use the downloading. See [Configuration settings](#) on page 99.

To set sounds, lights, and shakes for the application, select *App. settings*.

Running some applications may consume battery power faster (you may need to connect the phone to the charger).

Options available for an application

- *Delete* to delete the application or application set from the phone.
- *Details* to give additional information about the application.
- *Update version* to check if a new version of the application is available for download from the services (network service).
- *Web page* to provide further information or additional data for the application from an Internet page. This feature needs to be supported by the network. It is only shown if an Internet address has been provided with the application.
- *App. access* to control an application's access to functions that may require your acknowledgement before use, for example, network access.

Downloading a game or an application

Your phone supports J2ME™ Java applications. During downloading, the compatibility is checked, and the downloading is interrupted, for example, if the phone does not support the application.



Important: Only install applications from sources that offer adequate protection against harmful software.

You can download new Java applications in different ways:

- Press **Menu**, and select *Applications*. Press **Options**, and select *Downloads* and *Game downloads* or *App. downloads*.

The list of available bookmarks is shown. Select *More bookmarks* to access the list of bookmarks in the *Web* menu, see [Bookmarks](#) on page 137.

Select the appropriate bookmark to connect to the desired site.

To check the availability of different services, pricing and tariffs, contact your network operator or service provider.

- Press **Menu**, and select *Web* and *Download links*. See [Downloading](#) on page 138.

Your device may have some bookmarks loaded for sites not affiliated with Nokia. Nokia does not warrant or endorse these sites. If you choose to access them, you should take the same precautions, for security or content, as you would with any Internet site.

■ Web



You can access various services with your phone browser. These services may include, for example, weather reports, news, or flight times and financial information.

Check the availability of these services, pricing and tariffs with your network operator or the service provider whose service you wish to use. Service providers will also give you instructions on how to use their services.

With your phone browser, you can view the services that use Wireless Mark-Up Language (WML) or extensible HyperText Mark-up Language (XHTML) on their pages. The appearance of the pages may vary due to the limited size of the phone display. You may not be able to view all of the page details.

Basic steps for accessing and using services

1. Save the configuration settings that are required to access the service that you want to use.
2. Make a connection to the given service.
3. Start browsing the pages of the service.
4. Once you are finished browsing, end the connection to the service.

Setting up browsing

You may receive the configuration settings required for browsing as a configuration message from the network operator or service provider that offers the service that you want to use. See [Configuration settings service](#) on page 18.

To manage all the configuration settings, see [Configuration settings](#) on page 99.

Connecting to a service

Firstly, ensure that the correct configuration settings of the service that you want to use are activated.



- Press **Menu**, and select *Web, Settings* and *Configuration settings*.

- Select *Configuration*. Only the configurations that support browsing service are shown. Select a service provider, *Default*, or *Personal config*. for browsing. You may receive the browser settings as a configuration message, see [Configuration settings service](#) on page 18. To key in the configuration settings manually, see [Configuration settings](#) on page 99. Select *Account* and a browsing service account contained in the active configuration settings.
- *Display terminal window* and select *Yes* to perform manual user authentication for intranet connections.



Secondly, make a connection to the service, for example, press **Menu**, and select *Web* and *Home*, or in standby mode, press and hold .

Browsing the pages

After you connect to a service, you can start browsing its pages. The function of the phone keys may vary in different services. Follow the text guides on the phone display. For more information, contact your service provider.

If GPRS is selected as the data bearer, the  indicator is shown on the top left of the display during browsing. If you receive a call or a text message, or make a call during an (E)GPRS connection, the  indicator will be shown on the top right of the display to indicate that the (E)GPRS connection is suspended (on hold). After a call, for example, the phone tries to reconnect the (E)GPRS connection.

Browsing with phone keys

- Use any of the scroll keys to browse through the page.
- To select a highlighted item, press the call key , or press **Select** to open the link.
- To enter letters and numbers in the text editor, press  to **QWERTY**. To enter special characters, press .

Options while browsing

Press **Options** and the following options may be available. The service provider may also offer other options.



- **Use wallet info** to use the wallet card information from the **Wallet** application if the service page supports the wallet. Refer to **Wallet** on page 124.
- **Shortcuts** to open a new list of options that are specific to the page.
- **Home** to return to the homepage of the service provider.
- **Add bookmark** to save the page as a bookmark.
- **Bookmarks**. See **Bookmarks** on page 137.
- **Download links** to show the list of bookmarks for downloading.
- **Other options** to show a list of other options, for example options for the wallet and some security options.
- **Reload** to reload and update the current page.
- **Quit**. See **Quit browsing** on page 136.

Direct calling

The browser supports functions that you can access while browsing. You can make a voice call, send DTMF tones while a voice call is in progress, and save a name and a phone number from a page.

Quit browsing

To quit browsing and end the connection, press **Options**, and select *Quit*. When *Quit browsing?* is shown, press **Yes**.

Alternatively, press  twice, or press and hold .

Appearance settings of the browser

While browsing, press **Options** and select *Other options* and *Appear. settings*, or in standby mode, press **Menu**, and select *Web, Settings* and *Appearance settings*. Select

- *Text wrapping* and *On*, and the text continues on the next line. Select *Off*, and the text will be abbreviated.
- *Font size* and select *Extra small font*, *Small* or *Medium*.
- *Show images* and select *No* if you do not want the pictures on the page to be shown. This can speed up the browsing of pages that contain a lot of pictures.
- *Alerts* and select *Alert for unsecure connection* and *Yes* to set the phone to alert when a secure connection changes to an unsecure one during browsing. Select *Alert for unsecure items* and *Yes* to set the phone to alert when a secured page contains an unsecure item.

- *Character encoding* and *Content encoding* to select the encoding for the browser page content.
Select *Unicode (UTF-8) web addresses* and *On* if you want the phone to send an URL as an UTF-8 encoding.

Bookmarks

You can save page addresses as bookmarks in the phone memory.

1. While browsing, press **Options** and select *Bookmarks*, or in standby mode, press **Menu**, and select *Web* and *Bookmarks*.
2. Scroll to a bookmark, and press **Select** or the call key  to make a connection to the page associated with the bookmark.
Press **Options**, and select, for example, to view, edit, delete, or send the bookmark.

Your device may have some bookmarks loaded for sites not affiliated with Nokia. Nokia does not warrant or endorse these sites. If you choose to access them, you should take the same precautions, for security or content, as you would with any Internet site.

Receiving a bookmark

When you have received a bookmark (sent as a bookmark) *1 bookmark received* is displayed. Press **Show** and **Save** to save the bookmark, or press **Options**, and select *View* or *Delete* to view or delete it.

Downloading

To download more tones, images, games or applications to your phone while browsing, press **Options**, and select *Download links*, or in standby mode, press **Menu**, and select *Web* and *Download links*. Select to download tones, images, games, video clips, themes, or applications.



Note: Only install software from sources that offer adequate protection against viruses and other harmful software.

Service inbox

The phone is able to receive service messages (pushed messages) from your service provider. Service messages may be notifications of, for example, news headlines, and they may contain a text message or an address of a service.

- To view a received service message, press **Show**. If you press **Exit**, the message is moved to the *Service inbox*. To access the *Service inbox* later, press **Menu**, and select *Web*, and *Service inbox*.
- To manage a service message while browsing, press **Options**, and select *Other options* and *Service inbox*. Scroll to the message that you want, and press **Retrieve** to download the marked content from the page, or press **Options**, and select *Details* or *Delete*.

Service inbox settings

Press **Menu**, and select *Web*, *Settings* and *Service inbox settings*.

- To set the phone to receive (or reject) service messages, select *Service messages*, and *On* (or *Off*).

- To set the phone to receive messages only from content authors approved by the service provider, select *Message filter* and *On*. To view the list of the approved content authors, select *Trusted channels*.
- To automatically activate the browser when the phone has received a service message in standby mode if you have set the phone to receive service messages, select *Automatic connection*, and *On*.

If you select *Off*, the phone will activate the browser only after you select *Retrieve* when the phone has received a service message.

The cache memory

A cache is a memory location that is used to store data temporarily. If you have tried to access or have accessed confidential information requiring passwords, empty the cache after each use. The information or services you have accessed is stored in the cache.

To empty the cache:

- while browsing, press *Options*, and select *Other options*, and *Clear the cache*;
- in standby mode, press *Menu*, and select *Web*, and *Clear the cache*.

Cookies

A cookie is data that a site saves in your phone browser cache memory. The data can be, for example, your user information or your browsing preferences. Cookies will be saved until you clear the cache memory, see [The cache memory](#) on page 139.

1. While browsing, press **Options**, and select *Other options, Security* and *Cookie settings*, or in standby mode, press **Menu**, and select *Web, Settings, Security settings* and *Cookies*.
2. To allow or prevent the phone receiving cookies, select *Allow* or *Reject*.

Scripts over secure connection

You can select whether the scripts from a secure page are allowed to be run.

1. While browsing, press **Options**, and select *Other options, Security*, and select *Script settings*, or in standby mode, press **Menu**, and select *Web, Settings, Security settings*, and *Scripts over secure connection*.
2. To allow the scripts, select *Allow*.

Browser security

Security features may be required for some services, such as banking services or shopping on a site. For such connections you need security certificates and possibly a security module which may be available on your SIM card. For more information, contact your service provider.

Security module

The security module can contain certificates as well as private and public keys. The purpose of the security module is to improve security services for applications requiring a browser connection, and to allow you to use a digital signature. The certificates are saved in the security module by the service provider.

Press **Menu**, and select *Web, Settings, Security settings* and *Security module settings*. Select

- *Security module details* to show the security module title, its status, manufacturer and serial number.
- *Module PIN request* to set the phone to request the module PIN when using services provided by the security module.
- *Change module PIN* to change the module PIN, if allowed by the security module.
- *Change signing PIN* to select and change a signing PIN.

See also [Access codes](#) on page 16.

Certificates



Important: Note that even if the use of certificates makes the risks involved in remote connections and software installation considerably smaller, they must be used correctly in order to benefit from increased security. The existence of a certificate does not offer any protection by itself; the certificate manager must contain correct, authentic, or trusted certificates for increased security to be available. Certificates have a restricted lifetime. If Expired certificate or Certificate not valid yet is shown even if the certificate should be valid, check that the current date and time in your device are correct.

Before changing any certificate settings, you must make sure that you really trust the owner of the certificate and that the certificate really belongs to the listed owner.

There are three kinds of certificates: server certificates, authority certificates, and user certificates. You may receive these certificates from your service provider.

Authority certificates and user certificates may also be saved in the security module by the service provider.

 , the security indicator, is displayed during a connection if the data transmission between the phone and the content server is encrypted.

The security icon does not indicate that the data transmission between the gateway and the content server (or place where the requested resource is stored) is secure. The service provider secures the data transmission between the gateway and the content server.

Digital signature

You can make digital signatures with your phone. Using the digital signature can be the same as signing your name to a paper bill, contract or other document.

To make a digital signature, select a link on a page, for example, the title of the book that you want to buy and its price. The text to sign (possibly including amount, date, etc.) will be shown.

Check that the header text is *Read* and that the digital signature icon  is shown.

If the digital signature icon does not appear, there is a security breach, and you should not enter any personal data such as your signing PIN.

To sign the text, read all of the text first and then you can select **Sign**.

The text may not fit within a single screen. Therefore, make sure to scroll through and read all of the text before signing.

Select the user certificate you want to use. Key in the signing PIN (see [Access codes](#) on page 16) and press **OK**. The digital signature icon will disappear, and the service may display a confirmation of your purchase.

■ SIM services



In addition to the functions available on the phone, your SIM card may provide additional services that you can access in this menu which is shown only if it is supported by your SIM card. The name and contents of the menu depend entirely on the service available.

To set the phone to show you the confirmation messages sent between your phone and the network when you are using the SIM services, press **Menu**, and select *Settings, Phone settings, Confirm SIM service actions*, and *Yes*.

Accessing these services may involve sending a text message (SMS) or making a phone call for which you may be charged.

7. PC Connectivity

You can send and receive e-mails and access the Internet when your phone is connected to a compatible PC using an IR connection or data cable. You can use your phone with a variety of PC connectivity and data communications applications. With PC Suite, you can, for example, synchronise contacts, calendar, and to-do notes between your phone and a compatible PC

You may find more information and downloadable files on the Nokia website, www.nokia.com/pcsuite.

■ Using data communication applications

For information on using a data communication application, refer to the documentation provided with it.

Making or answering phone calls during a computer connection is not recommended as it might disrupt the operation.

8. Battery information

■ Charging and Discharging

Your device is powered by a rechargeable battery. The full performance of a new battery is achieved only after two or three complete charge and discharge cycles. The battery can be charged and discharged hundreds of times but it will eventually wear out. When the talk and standby times are noticeably shorter than normal, buy a new battery. Use only Nokia approved batteries, and recharge your battery only with Nokia approved chargers designated for this device.

Unplug the charger from the electrical plug and the device when not in use. Do not leave the battery connected to a charger. Overcharging may shorten its lifetime. If left unused, a fully charged battery will lose its charge over time. Temperature extremes can affect the ability of your battery to charge.

Use the battery only for its intended purpose. Never use any charger or battery that is damaged.

Do not short-circuit the battery. Accidental short-circuiting can occur when a metallic object such as a coin, clip, or pen causes direct connection of the positive (+) and negative (-) terminals of the battery. (These look like metal strips on the battery.) This might happen, for example, when you carry a spare battery in your pocket or purse. Short-circuiting the terminals may damage the battery or the connecting object.

Leaving the battery in hot or cold places, such as in a closed car in summer or winter conditions, will reduce the capacity and lifetime of the battery. Always try to keep the battery between 15°C and 25°C (59°F and 77°F). A device with a hot or cold battery may not work temporarily, even when the battery is fully charged. Battery performance is particularly limited in temperatures well below freezing.

Do not dispose of batteries in a fire! Dispose of batteries according to local regulations.
Please recycle when possible. Do not dispose as household waste.

9. Enhancements

A few practical rules about accessories and enhancements.

- Keep all accessories and enhancements out of the reach of small children.
- When you disconnect the power cord of any accessory or enhancement, grasp and pull the plug, not the cord.
- Check regularly that enhancements installed in a vehicle are mounted and are operating properly.
- Installation of any complex car enhancements must be made by qualified personnel only.

CARE AND MAINTENANCE

Your device is a product of superior design and craftsmanship and should be treated with care. The suggestions below will help you protect your warranty coverage.

- Keep the device dry. Precipitation, humidity and all types of liquids or moisture can contain minerals that will corrode electronic circuits. If your device does get wet, remove the battery and allow the device to dry completely before replacing it.
- Do not use or store the device in dusty, dirty areas. Its moving parts and electronic components can be damaged.
- Do not store the device in hot areas. High temperatures can shorten the life of electronic devices, damage batteries, and warp or melt certain plastics.
- Do not store the device in cold areas. When the device returns to its normal temperature, moisture can form inside the device and damage electronic circuit boards.
- Do not attempt to open the device other than as instructed in this guide.
- Do not drop, knock, or shake the device. Rough handling can break internal circuit boards and fine mechanics.
- Do not use harsh chemicals, cleaning solvents, or strong detergents to clean the device.
- Do not paint the device. Paint can clog the moving parts and prevent proper operation.
- Use a soft, clean, dry cloth to clean any lenses (such as camera, proximity sensor, and light sensor lenses).
- Use only the supplied or an approved replacement antenna. Unauthorised antennas, modifications, or attachments could damage the device and may violate regulations governing radio devices.

All of the above suggestions apply equally to your device, battery, charger, or any enhancement. If any device is not working properly, take it to the nearest authorized service facility for service.

ADDITIONAL SAFETY INFORMATION

■ Operating environment

Remember to follow any special regulations in force in any area and always switch off your device when its use is prohibited or when it may cause interference or danger. Use the device only in its normal operating positions. To maintain compliance with radio frequency exposure guidelines only use enhancements approved by Nokia for use with this device. When the device is on and being worn on the body, always use an approved holder or carrying case.

Parts of the device are magnetic. Metallic materials may be attracted to the device, and persons with a hearing aid should not hold the device to the ear with the hearing aid. Always secure the device in its holder, because metallic materials may be attracted by the earpiece. Do not place credit cards or other magnetic storage media near the device, because information stored on them may be erased.

■ Medical devices

Operation of any radio transmitting equipment, including wireless phones, may interfere with the functionality of inadequately protected medical devices. Consult a physician or the manufacturer of the medical device to determine if they are adequately shielded from external RF energy or if you have any questions. Switch off your device in health care facilities when any regulations posted in these areas instruct you to do so. Hospitals or health care facilities may be using equipment that could be sensitive to external RF energy.

Pacemakers

Pacemaker manufacturers recommend that a minimum separation of 6 in. (15.3 cm) be maintained between a wireless phone and a pacemaker to avoid potential interference with

the pacemaker. These recommendations are consistent with the independent research by and recommendations of Wireless Technology Research. Persons with pacemakers should:

- always keep the device more than 6 in. (15.3 cm) from their pacemaker when the device is switched on;
- not carry the device in a breast pocket; and
- hold the device to the ear opposite the pacemaker to minimise the potential for interference.

If you have any reason to suspect that interference is taking place, switch off your device immediately.

Hearing aids

Some digital wireless devices may interfere with some hearing aids. If interference occurs, consult your service provider.

■ Vehicles

RF signals may affect improperly installed or inadequately shielded electronic systems in motor vehicles such as electronic fuel injection systems, electronic antiskid (antilock) braking systems, electronic speed control systems, air bag systems. For more information, check with the manufacturer or its representative of your vehicle or any equipment that has been added.

Only qualified personnel should service the device, or install the device in a vehicle. Faulty installation or service may be dangerous and may invalidate any warranty that may apply to the device. Check regularly that all wireless device equipment in your vehicle is mounted and operating properly. Do not store or carry flammable liquids, gases, or explosive materials in the same compartment as the device, its parts, or enhancements. For vehicles equipped with an air bag, remember that air bags inflate with great force. Do not place objects, including installed or portable wireless equipment in the area over the air bag or in the air

bag deployment area. If in-vehicle wireless equipment is improperly installed and the air bag inflates, serious injury could result.

Using your device while flying in aircraft is prohibited. Switch off your device before boarding an aircraft. The use of wireless teledevices in an aircraft may be dangerous to the operation of the aircraft, disrupt the wireless telephone network, and may be illegal.

■ Potentially explosive environments

Switch off your device when in any area with a potentially explosive atmosphere and obey all signs and instructions. Potentially explosive atmospheres include areas where you would normally be advised to turn off your vehicle engine. Sparks in such areas could cause an explosion or fire resulting in bodily injury or even death. Switch off the device at refuelling points such as near gas pumps at service stations. Observe restrictions on the use of radio equipment in fuel depots, storage, and distribution areas, chemical plants or where blasting operations are in progress. Areas with a potentially explosive atmosphere are often but not always clearly marked. They include below deck on boats, chemical transfer or storage facilities, vehicles using liquefied petroleum gas (such as propane or butane), and areas where the air contains chemicals or particles such as grain, dust or metal powders.

■ Safety information about video games

About photosensitive seizures

A very small percentage of people may experience a seizure when exposed to certain visual images, including flashing lights or patterns that may appear in video games. Even people who have no history of seizures or epilepsy may have an undiagnosed condition that can cause photosensitive epileptic seizures while watching video games. These seizures may have a variety of symptoms, including lightheadedness, altered vision, eye or face twitching, jerking or shaking of arms or legs, disorientation, confusion, or momentary loss of

awareness. Seizures may also cause loss of consciousness or convulsions that can lead to injury from falling down or striking nearby objects.

Immediately stop playing and consult a doctor if you experience any of these symptoms. Adults who allow teenagers (or children) to play the games should watch for or ask their children about these symptoms as they are more likely than adults to experience these seizures. The risk of photosensitive epileptic seizures may be reduced by playing in a well-lit room and by not playing when you are drowsy or fatigued. If you or any of your relatives have a history of seizures or epilepsy, consult a doctor before playing.

Play safely

Take a break from playing games at least every half hour. Stop playing immediately if you begin to feel tired or if you experience an unpleasant sensation or pain in your hands and/or arms. If the condition persists, consult a doctor.

Use of vibration can aggravate injuries. Do not turn vibration on if you have any ailment in the bones or joints of your fingers, hands, wrists, or arms.

■ Emergency calls



Important: Wireless phones, including this device, operate using radio signals, wireless networks, landline networks, and user-programmed functions. Because of this, connections in all conditions cannot be guaranteed. You should never rely solely on any wireless device for essential communications like medical emergencies.

To make an emergency call:

1. If the device is not on, switch it on. Check for adequate signal strength.
Some networks may require that a valid SIM card is properly inserted in the device.
2. Press  as many times as needed to clear the display and ready the device for calls.

3. Key in the official emergency number for your present location. Emergency numbers vary by location.
4. Press the call key .

If certain features are in use, you may first need to turn those features off before you can make an emergency call. If the device is in offline or flight mode you must change the profile to activate the phone function before you can make an emergency call. Consult this guide or your service provider for more information.

When making an emergency call, give all the necessary information as accurately as possible. Your wireless device may be the only means of communication at the scene of an accident. Do not end the call until given permission to do so.

■ Certification information (SAR)

THIS DEVICE MEETS INTERNATIONAL GUIDELINES FOR EXPOSURE TO RADIO WAVES

Your mobile device is a radio transmitter and receiver. It is designed and manufactured not to exceed the limits for exposure to radio frequency (RF) recommended by international guidelines (ICNIRP). These limits are part of comprehensive guidelines and establish permitted levels of RF energy for the general population. The guidelines were developed by independent scientific organisations through periodic and thorough evaluation of scientific studies. The guidelines include a substantial safety margin designed to assure the safety of all persons, regardless of age and health.

The exposure standard for mobile devices employs a unit of measurement known as the Specific Absorption Rate, or SAR. The SAR limit stated in the international guidelines is 2.0 W/kg*. Tests for SAR are conducted using standard operating positions with the device transmitting at its highest certified power level in all tested frequency bands. Although the SAR is determined at the highest certified power level, the actual SAR of the device while operating can be well below the maximum value. This is because the device is designed to

operate at multiple power levels so as to use only the power required to reach the network. In general, the closer you are to a base station, the lower the power output of the device.

The highest SAR value for this device when tested for use at the ear is 0.46 W/kg.

This device meets RF exposure guidelines when used either in the normal use position against the ear or when positioned at least 1.5 cm away from the body. When a carry case, belt clip or holder is used for body-worn operation, it should not contain metal and should position the product at least 1.5 cm away from your body.

In order to transmit data files or messages, this device requires a quality connection to the network. In some cases, transmission of data files or messages may be delayed until such a connection is available. Ensure the above separation distance instructions are followed until the transmission is completed.

* The SAR limit for mobile devices used by the public is 2.0 watts/kilogram (W/kg) averaged over ten grams of body tissue. The guidelines incorporate a substantial margin of safety to give additional protection for the public and to account for any variations in measurements. SAR values may vary depending on national reporting requirements and the network band. For SAR information in other regions please look under product information at www.nokia.com.