

Features:

- Isolated mounting base 2500V~
- Pressure contact technology with Increased power cycling capability
- Space and weight savings

Typical Applications

- Inverter
- Inductive heating
- Chopper

I_o **175 A**
 V_{RRM} **600~1800 V**
 I_{FSM} **1.7 A × 10³**
 I^2t **14.5 A² S × 10³**



SYMBOL	CHARACTERISTIC	TEST CONDITIONS	T _j (°C)	VALUE			UNIT
				Min	Type	Max	
I _o	DC output current	Three-phase full wave rectifying circuit, T _C =100°C	150			175	A
V _{RRM}	Repetitive peak reverse voltage	V _{RRM} tp=10ms V _{RSM} = V _{RRM} +100V	150	600		1800	V
I _{RRM}	Repetitive peak current	at V _{RRM}	150			12	mA
I _{FSM}	Surge forward current	10ms half sine wave	150			1.7	KA
I ² t	I ² T for fusing coordination	V _R =0.6V _{RRM}					14.5
V _{FO}	Threshold voltage		150			0.8	V
r _F	Forward slop resistance						3.1
V _{FM}	Peak forward voltage	I _{FM} =175A	25			1.51	V
R _{th(j-c)}	Thermal resistance Junction to case	Single side cooled				0.14	°C /W
R _{th(c-h)}	Thermal resistance case to heatsink	Single side cooled				0.07	°C /W
V _{iso}	Isolation voltage	50Hz, R.M.S, t=1min, I _{iso} : 1mA(max)		2500			V
F _m	Terminal connection torque(M6)				6		N·m
	Mounting torque(M5)				4		N·m
T _{stg}	Stored temperature			-40		125	°C
W _t	Weight				450		g
Outline	411H5/221H5						

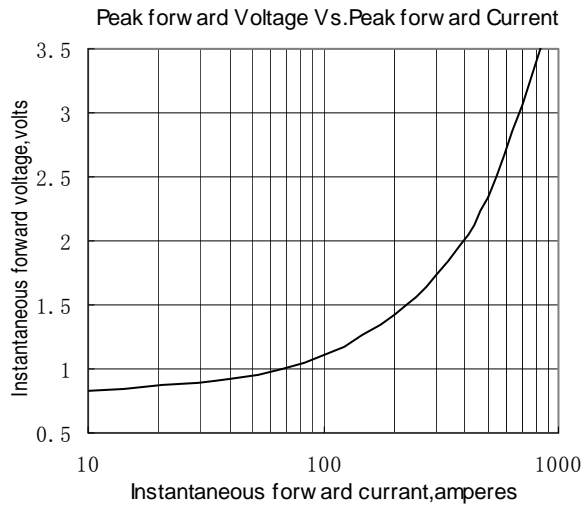

Fig.1

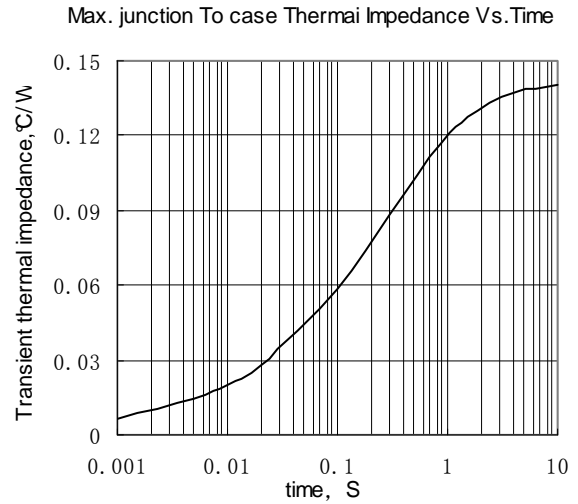

Fig.2

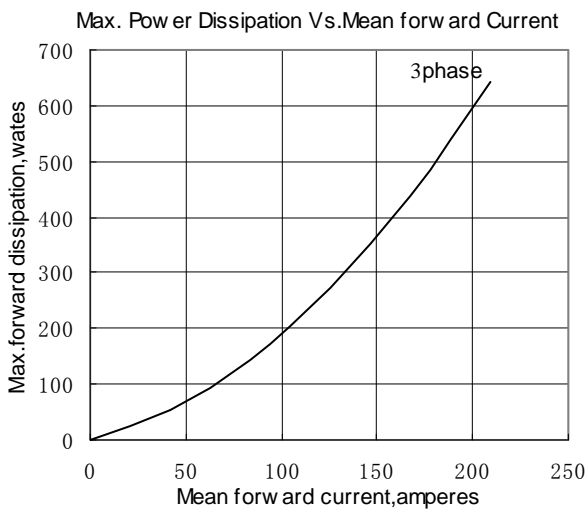

Fig.3

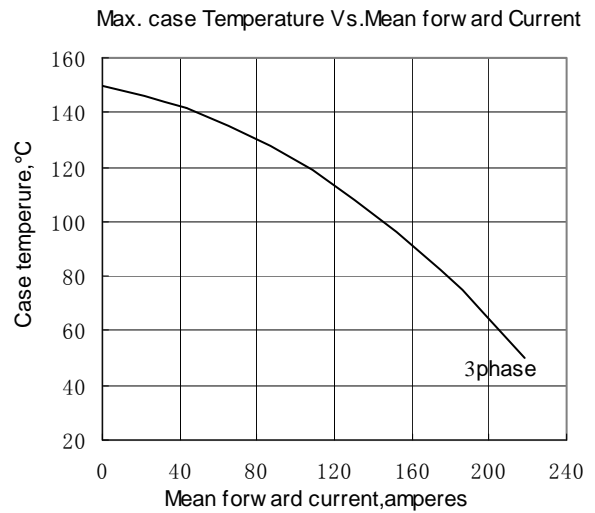

Fig.4

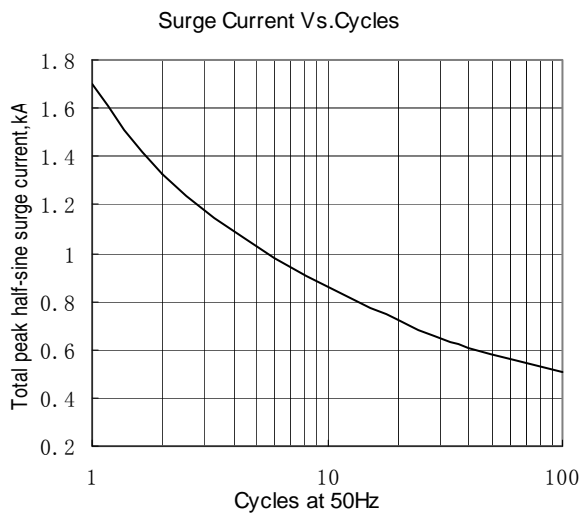

Fig.5

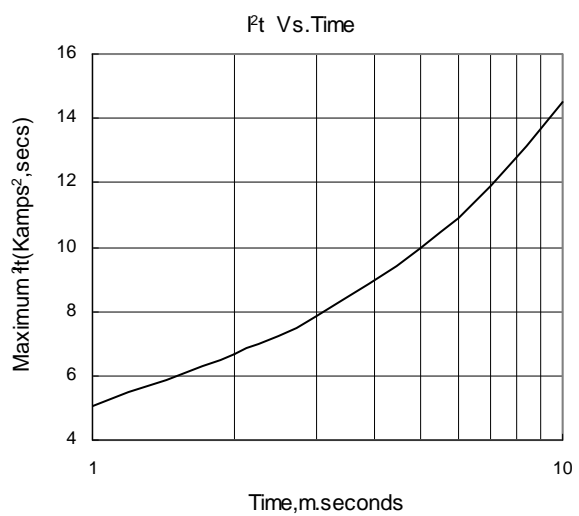
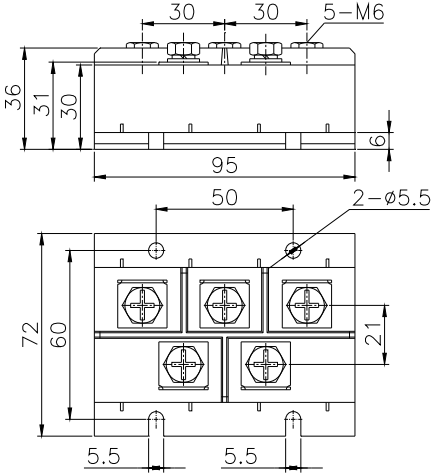

Fig.6

Outline:



411H5

