

Features:

- Non-Isolated.Mounting base as common
- Pressure contact technology with
Increased power cycling capability
- Low on-state voltage drop

Typical Applications

- Welding Power Supply
- Various DC Power supplies
- DC supply for PWM inverter

$I_{T(AV)}$ **150 A**
 V_{DRM}/V_{RRM} **800~1800 V**
 I_{TSM} **$3.9 A \times 10^3$**
 I^2t **$76 A^2 S \times 10^3$**



SYMBOL	CHARACTERISTIC	TEST CONDITIONS	T _j (°C)	VALUE			UNIT
				Min	Type	Max	
I _{T(AV)}	Mean on-state current	180° half sine wave 50Hz Single side cooled, T _c =90°C	125			150	A
I _{T(RMS)}	RMS on-state current		125			236	A
V _{DRM} V _{RRM}	Repetitive peak off-state voltage Repetitive peak reverse voltage	V _{DRM} &V _{RRM} tp=10ms V _{DsM} &V _{RSM} = V _{DRM} &V _{RRM} +100V respectively	125	800		1800	V
I _{DRM} I _{RRM}	Repetitive peak current	at V _{DRM} at V _{RRM}	125			12	mA
I _{TSM}	Surge on-state current	10ms half sine wave	125			3.9	KA
I ² t	I ² T for fusing coordination	V _R =60%V _{RRM}				76	A ² s*10 ³
V _{TO}	Threshold voltage		125			0.80	V
r _T	On-state slop resistance					1.74	mΩ
V _{TM}	Peak on-state voltage	I _{TM} =450A	25			1.67	V
dv/dt	Critical rate of rise of off-state voltage	V _{DM} =67%V _{DRM}	125			800	V/μs
di/dt	Critical rate of rise of on-state current	Gate source 1.5A t _r ≤0.5μs Repetitive	125			100	A/μs
I _{GT}	Gate trigger current	V _A =12V, I _A =1A	25	30		100	mA
V _{GT}	Gate trigger voltage			0.8		2.5	V
I _H	Holding current			20		100	mA
V _{GD}	Non-trigger gate voltage	At 67%V _{DRM}	125	0.2			V
R _{th(j-c)}	Thermal resistance Junction to case	Single side cooled				0.160	°C /W
R _{th(c-h)}	Thermal resistance case to heatsink	Single side cooled				0.1	°C /W
F _m	Thermal connection torque(M6)				6.0		N·m
	Mounting torque(M6)				6.0		N·m
T _{stg}	Stored temperature			-40		125	°C
W _t	Weight				380		g
Outline	213F4/210F2						

Peak on-state Voltage Vs. Peak on-state Current

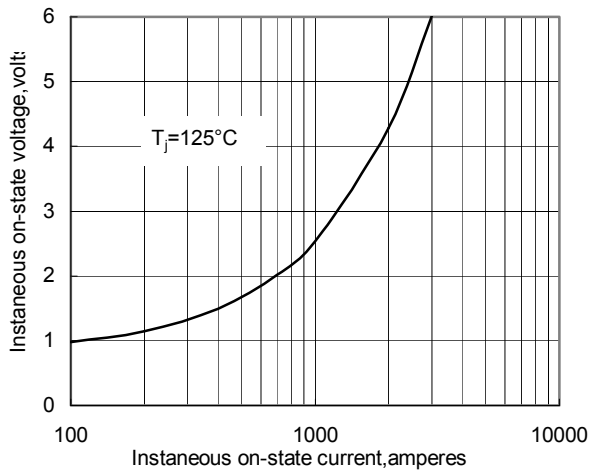

Fig.1

Max. junction To case Thermal Impedance Vs. Time

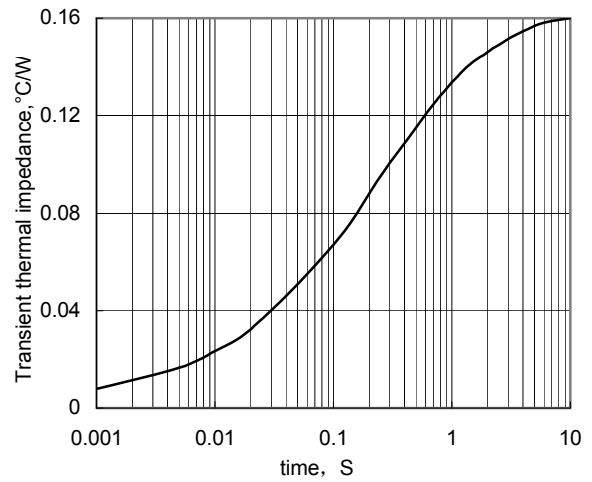

Fig.2

Max. Power Dissipation Vs. on-state Current

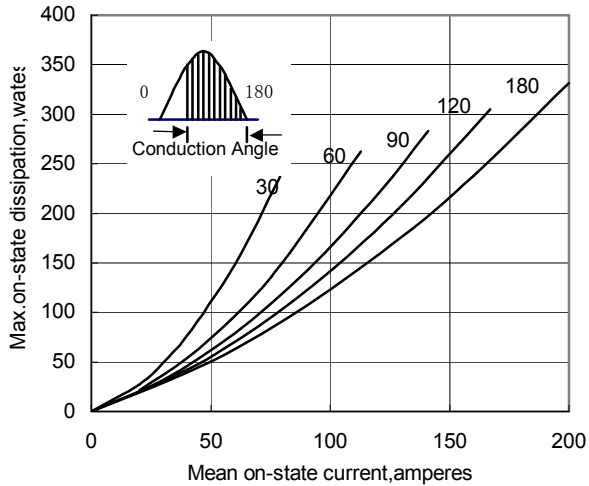

Fig.3

Max. case Temperature Vs. Mean on-state Current

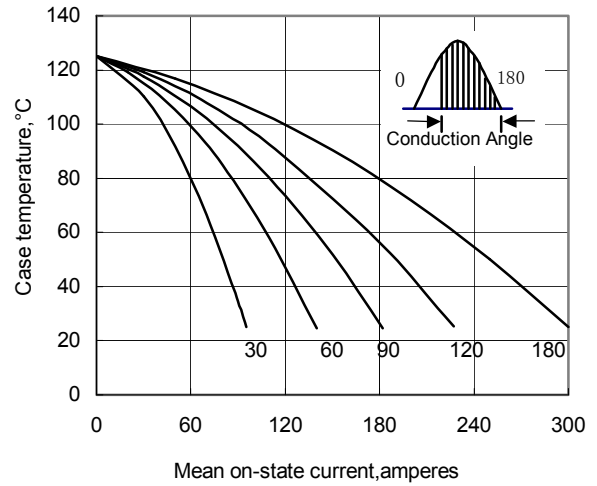

Fig.4

Max. Power Dissipation Vs. Mean on-state Current

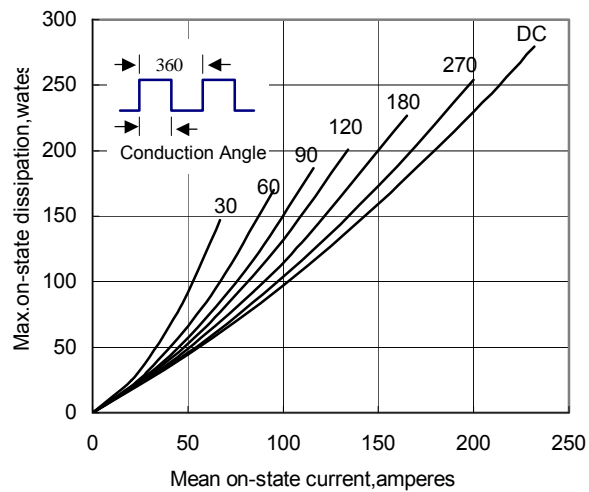

Fig.5

Max. case Temperature Vs. Mean on-state Current

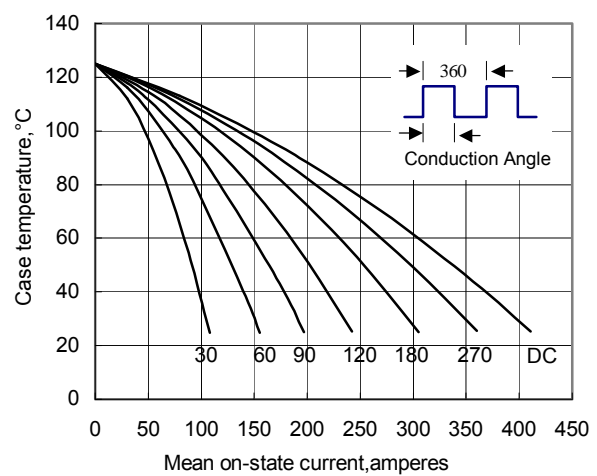

Fig.6

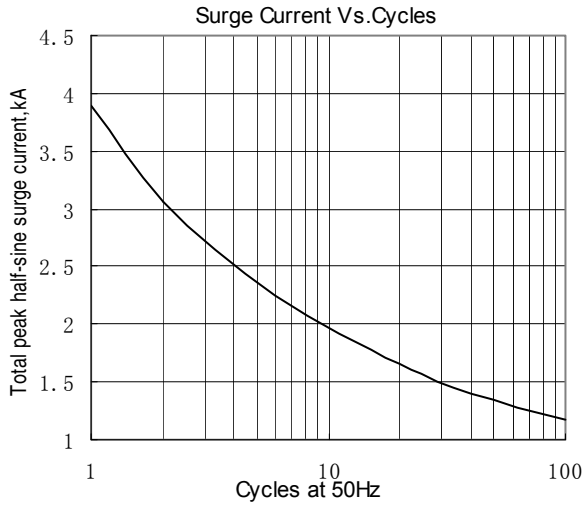

Fig.7

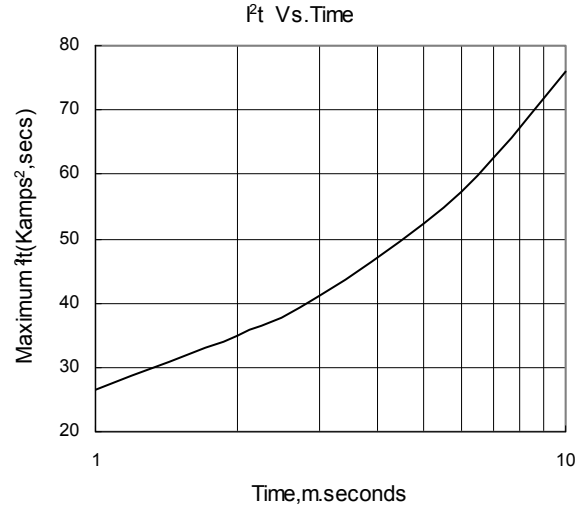

Fig.8

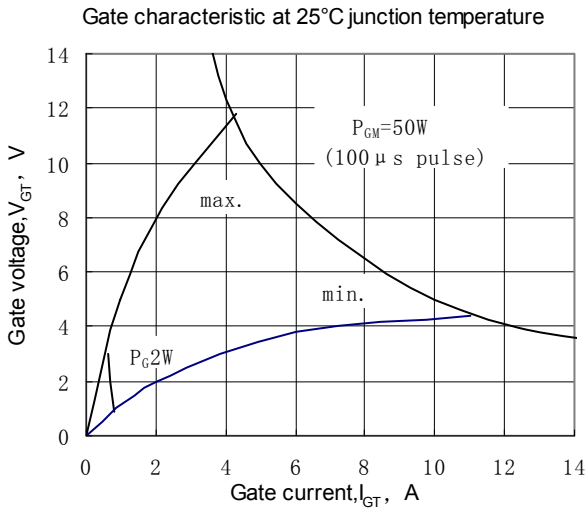

Fig.9

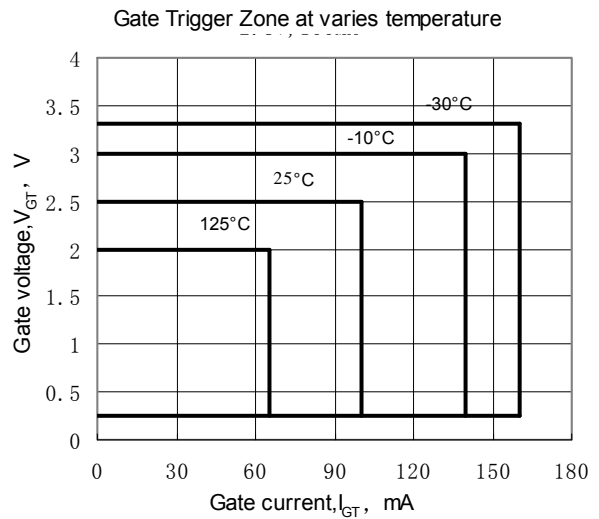
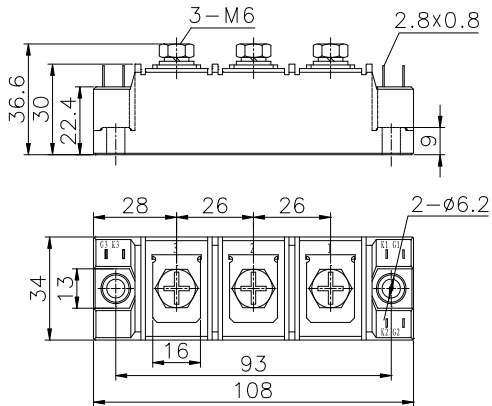

Fig.10

Outline:



213F4

