

Features:

- Nin-Isolated.Mounting base as common anode cathode terminal.
- Pressure contact technology with Incrtased power cycling capability
- Low forward voltage drop

Typical Applications

- Welding Power Supply
- Various Dc power supplies.

$I_{F(AV)}$ **150 A**
 V_{RRM} **800~1800 V**
 I_{FSM} **$4.6 A \times 10^3$**
 I^2t **$106 A^2 S \cdot 10^3$**



SYMBOL	CHARACTERISTIC	TEST CONDITIONS	T _j (°C)	VALUE			UNIT
				Min	Type	Max	
$I_{F(AV)}$	Mean forward current	180° half sine wave 50Hz Single side cooled, T _c =100°C	150			150	A
$I_{F(RMS)}$	RMS forward current		150			236	A
V_{RRM}	Repetitive peak reverse voltage	V _{RRM} tp=10ms V _{RSM} = V _{RRM} +100V	150	800		1800	V
I_{RRM}	Repetitive peak current	at V _{RRM}	150			12	mA
I_{FSM}	Surge forward current	10ms half sine wave	150			4.6	KA
I^2t	I ² T for fusing coordination	V _R =0.6V _{RRM}					106
V_{FO}	Threshold voltage		150			0.80	V
r_F	Forward slop resistance						1.53
V_{FM}	Peak forward voltage	I _{FM} =450A	25			1.57	V
$R_{th(j-c)}$	Thermal resistance Junction to case	Single side cooled				0.240	°C /W
$R_{th(c-h)}$	Thermal resistance case to heatsink	Single side cooled				0.1	°C /W
F_m	Terminal connection torque(M6)				6		N·m
	Mounting torque(M6)				6		N·m
T_{stg}	Stored temperature			-40		125	°C
W_t	Weight				380		g
Outline	213F4/210F2						

Peak forward Voltage Vs. Peak forward Current

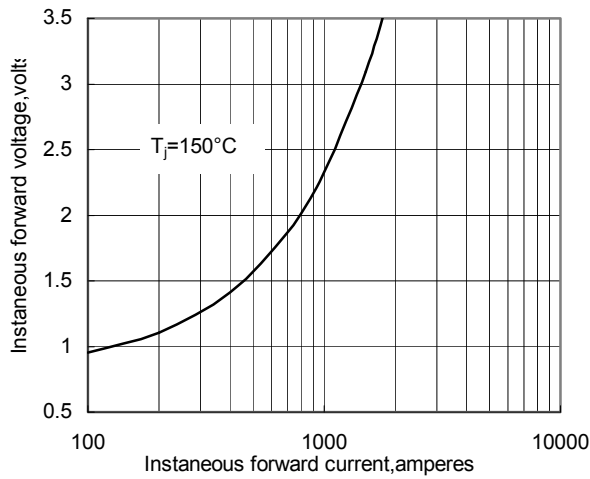

Fig.1

Max. junction To case Thermal Impedance Vs. Time

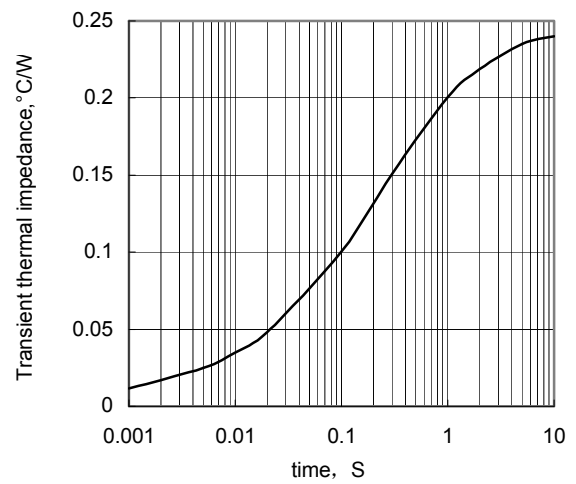

Fig.2

Max. Power Dissipation Vs. Mean forward

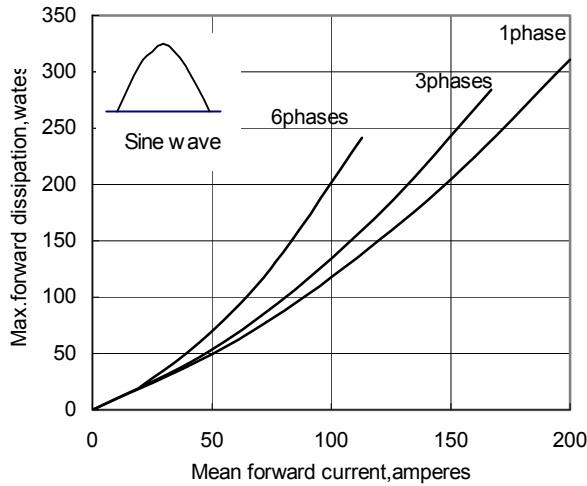

Fig.3

Max. case Temperature Vs. Mean forward

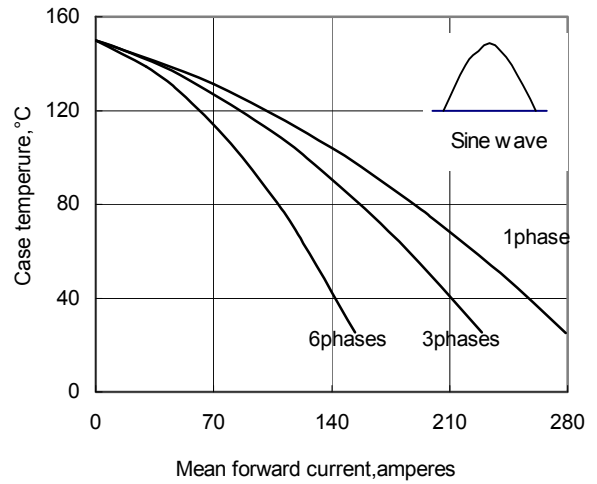

Fig.4

Max. Power Dissipation Vs. Mean forward Current

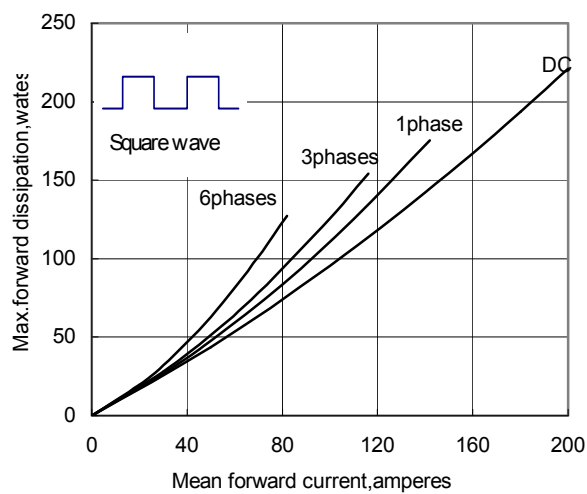

Fig.5

Max. case Temperature Vs. Mean forward Current

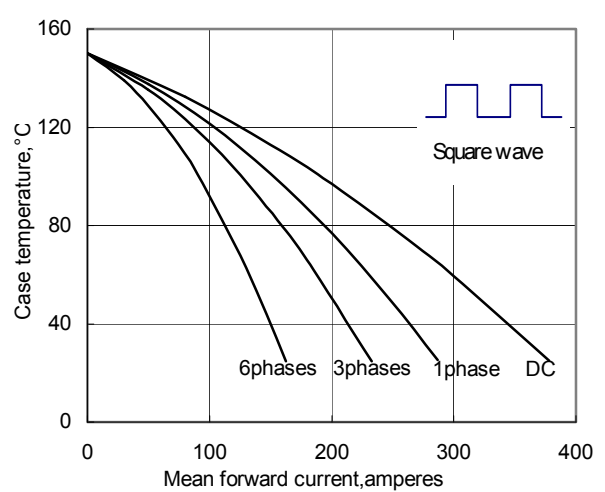

Fig.6

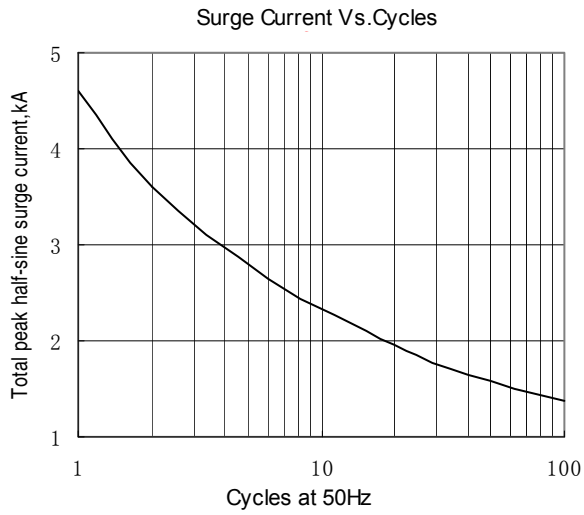

Fig.7

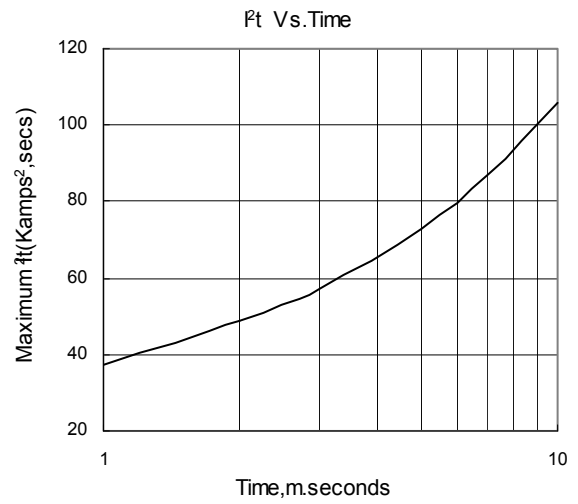
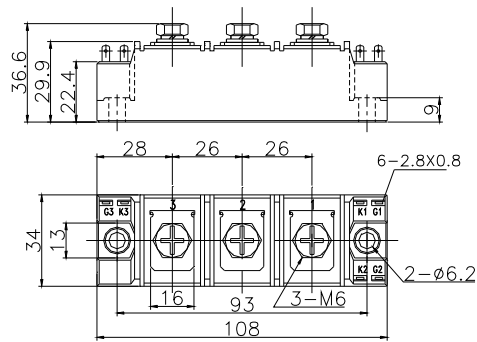

Fig.8

Outline:



213F4

