

Features:

- Isolated mounting base 2500V~
- Pressure contact technology with
Increased power cycling capability
- Space and weight savings

Typical Applications

- AC/DC Motor drives
- Various rectifiers
- DC supply for PWM inverter

$I_{F(AV)}$ **500A**
 V_{RRM} **600~1800V**
 I_{FSM} **$16A \times 10^3$**
 I^2t **$1280A^2 S \times 10^3$**



SYMBOL	CHARACTERISTIC	TEST CONDITIONS	T _j (°C)	VALUE			UNIT
				Min	Type	Max	
$I_{F(AV)}$	Mean forward current	180° half sine wave 50Hz Single side cooled, T _C =100°C	150			500	A
$I_{F(RMS)}$	RMS forward current		150			785	A
V_{RRM}	Repetitive peak reverse voltage	V_{RRM} tp=10ms $V_{RSM} = V_{RRM} + 100V$	150	600		1800	V
I_{RRM}	Repetitive peak current	at V_{RRM}	150			40	mA
I_{FSM}	Surge forward current	10ms half sine wave	150			16.0	KA
I^2t	I^2T for fusing coordination	$V_R = 0.6V_{RRM}$					1280
V_{FO}	Threshold voltage		150			0.75	V
r_F	Forward slop resistance						0.30
V_{FM}	Peak forward voltage	$I_{FM} = 1500A$	25			1.45	V
$R_{th(j-c)}$	Thermal resistance Junction to case	At 180° sine Single side cooled				0.090	°C /W
$R_{th(c-h)}$	Thermal resistance case to heatsink	At 180° sine Single side cooled				0.024	°C /W
V_{iso}	Isolation voltage	50Hz, R.M.S, t=1min, I _{iso} :1mA(max)		2500			V
F_m	Terminal connection torque(M10)				12		N·m
	Mounting torque(M6)				6		N·m
T_{stg}	Stored temperature			-40		125	°C
W_t	Weight				2040		g
Outline	414F3/416F3/408F3/410F3/417F2						

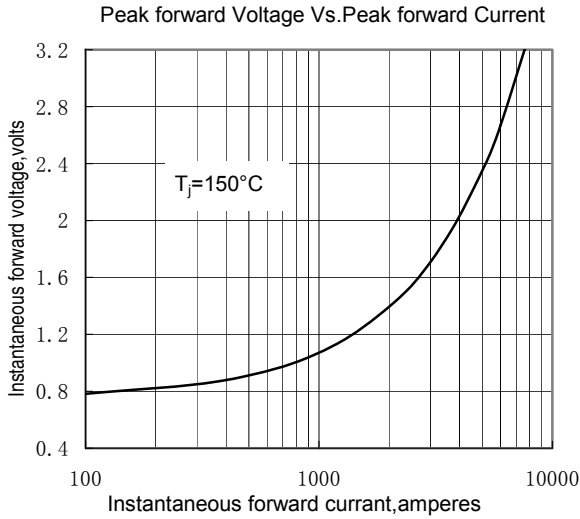

Fig.1

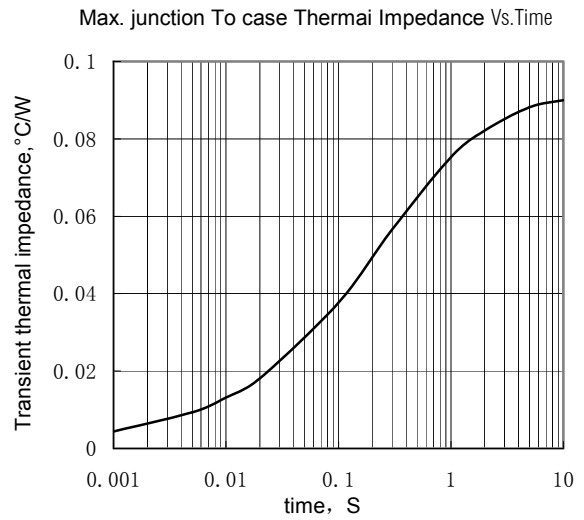

Fig.2

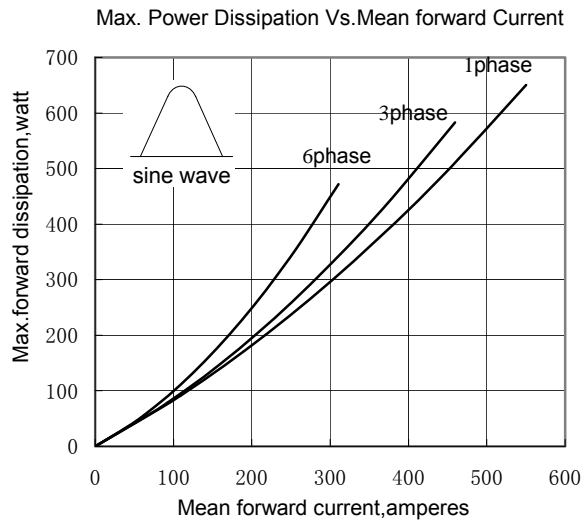

Fig.3

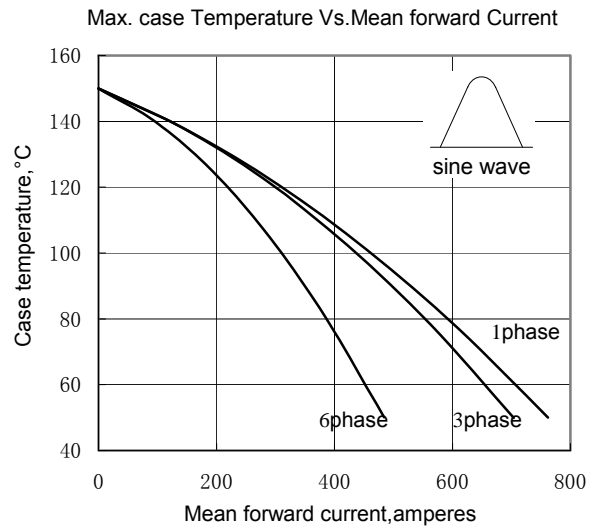

Fig.4

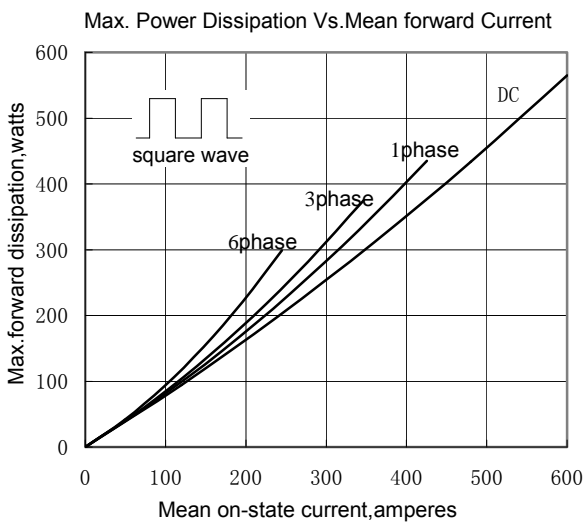

Fig.5

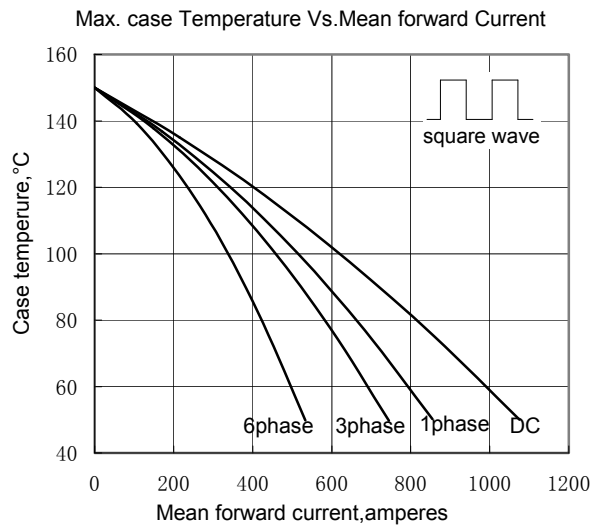

Fig.6

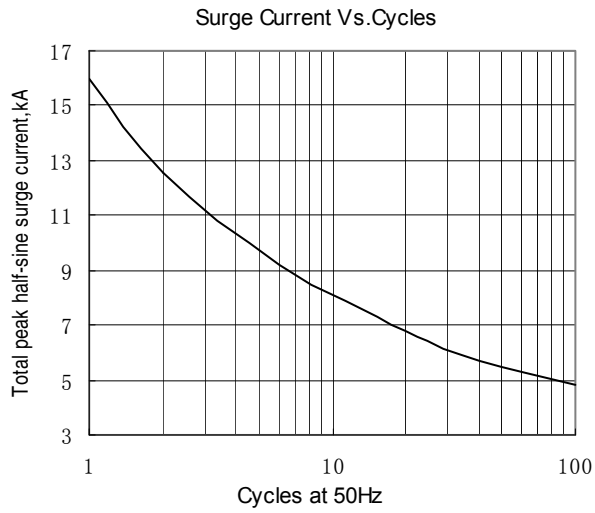

Fig.7

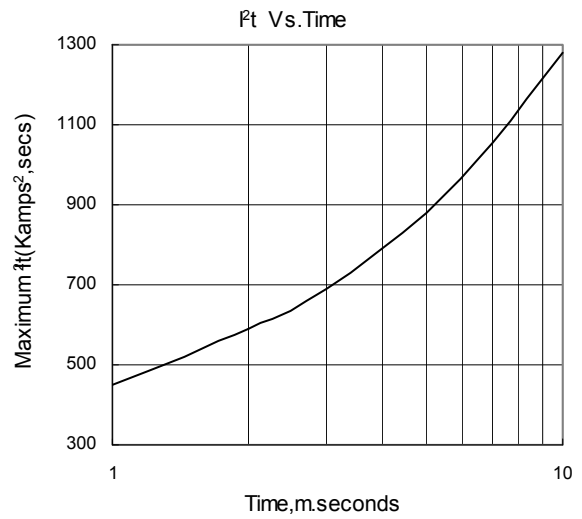
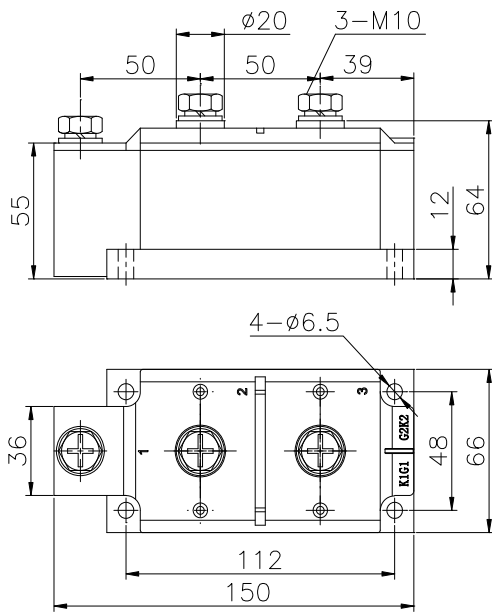

Fig.8

Outline:



414F3

