

### Features:

- Isolated mounting base 2500V~
- Pressure contact technology with  
Increased power cycling capability
- Space and weight savings

### Typical Applications

- AC/DC Motor drives
- Various rectifiers
- DC supply for PWM inverter

$I_{F(AV)}$       **400A**  
 $V_{RRM}$         **600~1800V**  
 $I_{FSM}$          **13 A×10<sup>3</sup>**  
 $I^2t$              **845A<sup>2</sup> S×10<sup>3</sup>**



SYMBOL	CHARACTERISTIC	TEST CONDITIONS	T <sub>J</sub> (°C)	VALUE			UNIT
				Min	Type	Max	
$I_{F(AV)}$	Mean forward current	180° half sine wave 50Hz Single side cooled, T <sub>C</sub> =100°C	150			400	A
$I_{F(RMS)}$	RMS forward current		150			628	A
$V_{RRM}$	Repetitive peak reverse voltage	V <sub>RRM</sub> tp=10ms V <sub>RSM</sub> = V <sub>RRM</sub> +100V	150	600		1800	V
$I_{RRM}$	Repetitive peak current	at V <sub>RRM</sub>	150			30	mA
$I_{FSM}$	Surge forward current	10ms half sine wave	150			13.0	KA
$I^2t$	I <sup>2</sup> T for fusing coordination	V <sub>R</sub> =0.6V <sub>RRM</sub>					845
$V_{FO}$	Threshold voltage		150			0.75	V
$r_F$	Forward slop resistance						0.50
$V_{FM}$	Peak forward voltage	I <sub>FM</sub> =1200A	25			1.48	V
$R_{th(j-c)}$	Thermal resistance Junction to case	At 180° sine: Single side cooled				0.100	°C /W
$R_{th(c-h)}$	Thermal resistance case to heatsink	At 180° sine: Single side cooled				0.04	°C /W
$V_{iso}$	Isolation voltage	50Hz, R.M.S, t=1min, I <sub>iso</sub> :1mA(max)		2500			V
$F_m$	Terminal connection torque(M8)				12		N·m
	Mounting torque(M6)				6		N·m
$T_{stg}$	Stored temperature			-40		125	°C
$W_t$	Weight				1350		g
<b>Outline</b>	415F3/424F3						

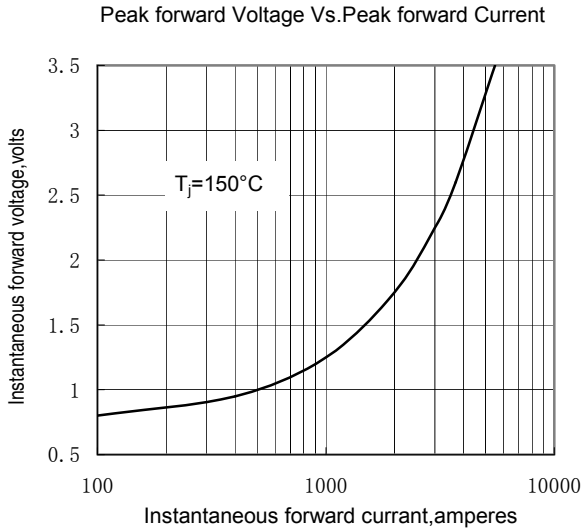

Fig.1

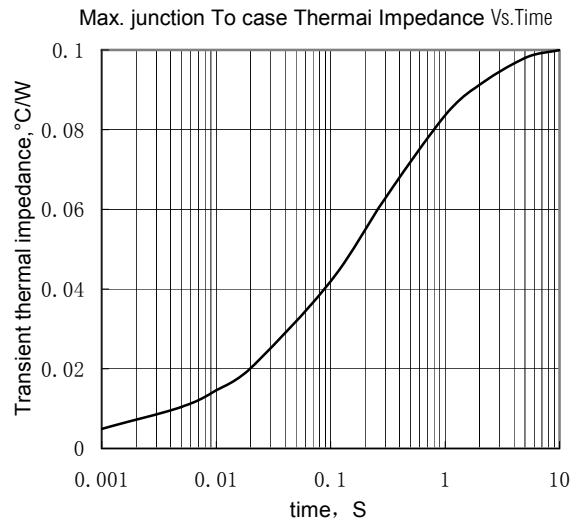

Fig.2

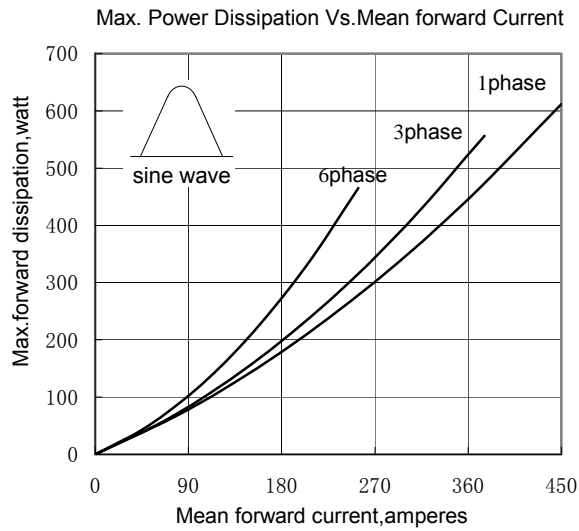

Fig.3

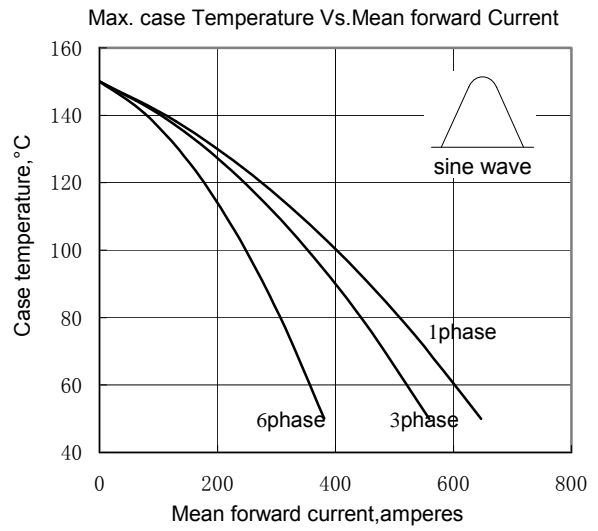

Fig.4

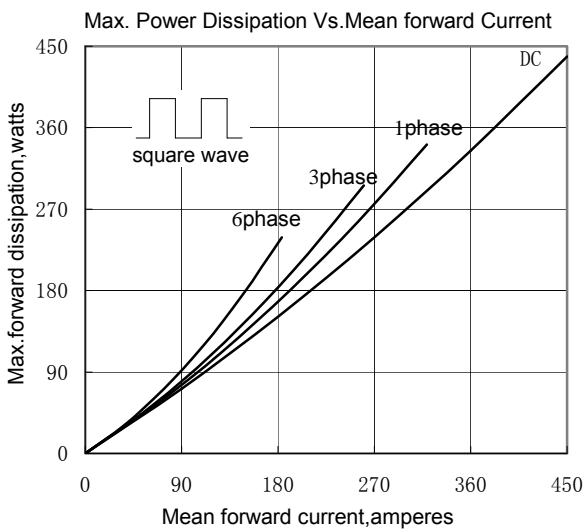

Fig.5

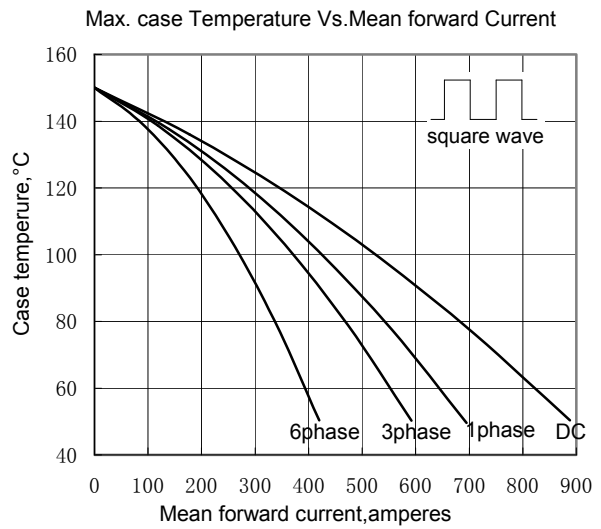
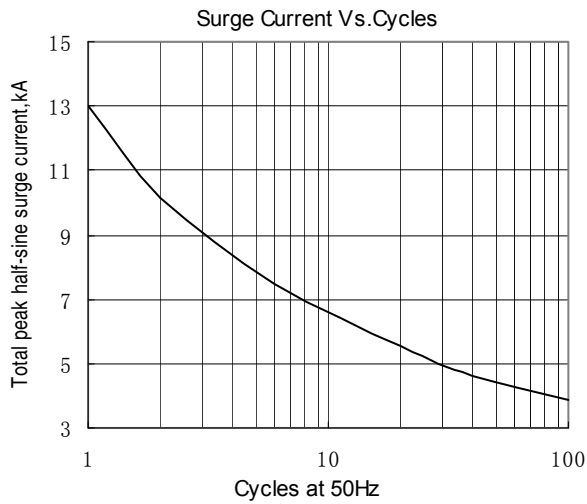
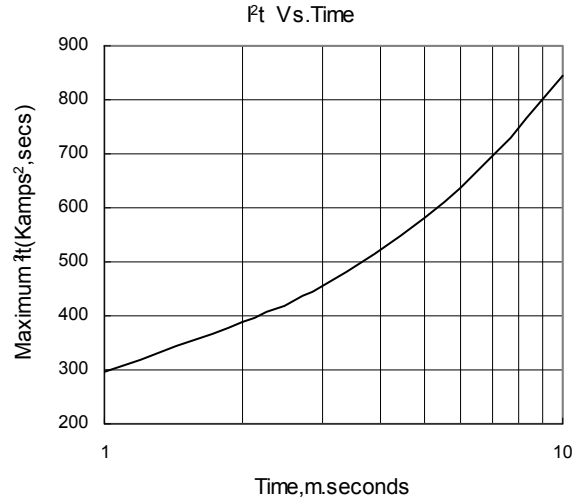

Fig.6

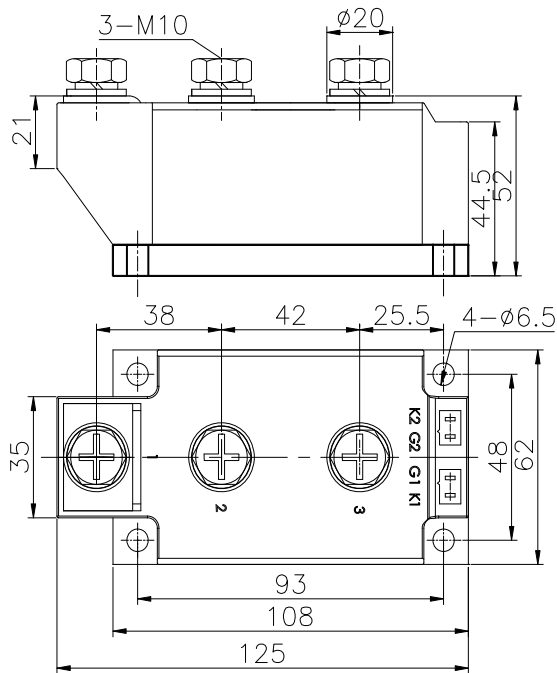

**Fig.7**



**Fig.8**

**Outline:**



**415F3**

