

Features:

- Isolated mounting base 2500V~
- Pressure contact technology with
Increased power cycling capability
- Space and weight savings

Typical Applications

- AC/DC Motor drives
- Various rectifiers
- DC supply for PWM inverter

$I_{F(AV)}$	250A
V_{RRM}	600~1800V
I_{FSM}	$9.5 A \times 10^3$
I^2t	$451A^2 S \times 10^3$



SYMBOL	CHARACTERISTIC	TEST CONDITIONS	$T_j(^{\circ}C)$	VALUE			UNIT
				Min	Type	Max	
$I_{F(AV)}$	Mean forward current	180° half sine wave 50Hz Single side cooled, $T_c=100^{\circ}C$	150			250	A
$I_{F(RMS)}$	RMS forward current		150			393	A
V_{RRM}	Repetitive peak reverse voltage	V_{RRM} tp=10ms $V_{RSM} = V_{RRM} + 100V$	150	600		1800	V
I_{RRM}	Repetitive peak current	at V_{RRM}	150			20	mA
I_{FSM}	Surge forward current	10ms half sine wave	150			9.50	KA
I^2t	I^2T for fusing coordination	$V_R=0.6V_{RRM}$				451	$A^2s \times 10^3$
V_{FO}	Threshold voltage		150			0.75	V
r_F	Forward slop resistance					0.76	mΩ
V_{FM}	Peak forward voltage	$I_{FM}=750A$	25			1.43	V
$R_{th(j-c)}$	Thermal resistance Junction to case	At 180° sine: Single side cooled				0.14	$^{\circ}C/W$
$R_{th(c-h)}$	Thermal resistance case to heatsink	At 180° sine: Single side cooled				0.04	$^{\circ}C/W$
V_{iso}	Isolation voltage	50Hz, R.M.S, t=1min, $I_{iso}: 1mA(max)$		2500			V
F_m	Terminal connection torque(M8)				12		N·m
	Mounting torque(M6)				6		N·m
T_{stg}	Stored temperature			-40		125	$^{\circ}C$
W_t	Weight				860		g
Outline	413F3/422F3						

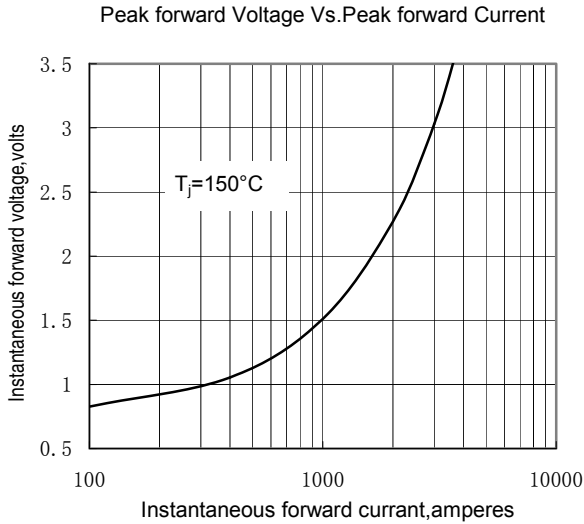

Fig.1

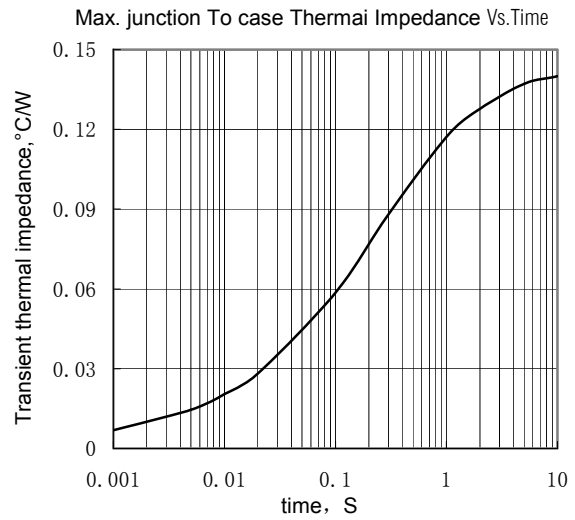

Fig.2

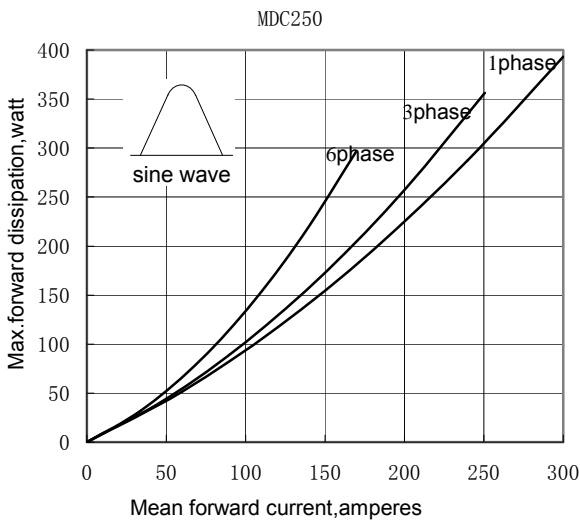

Fig.3

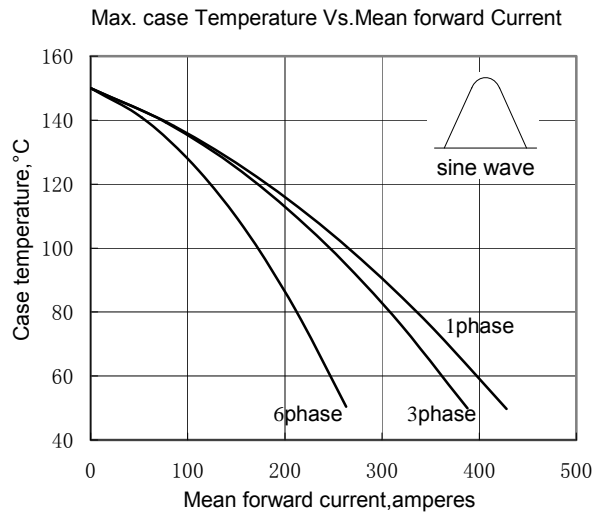

Fig.4

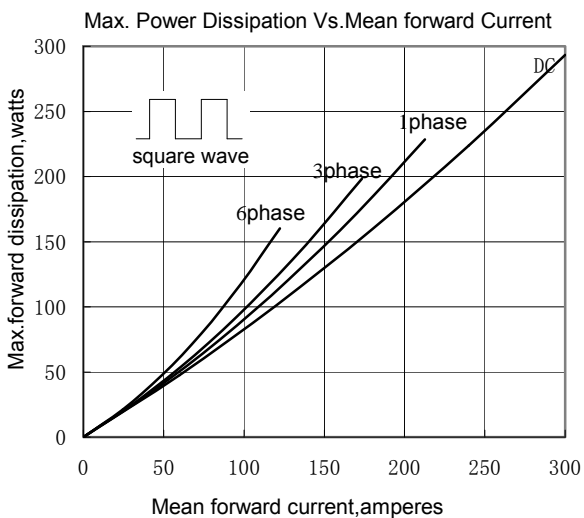

Fig.5

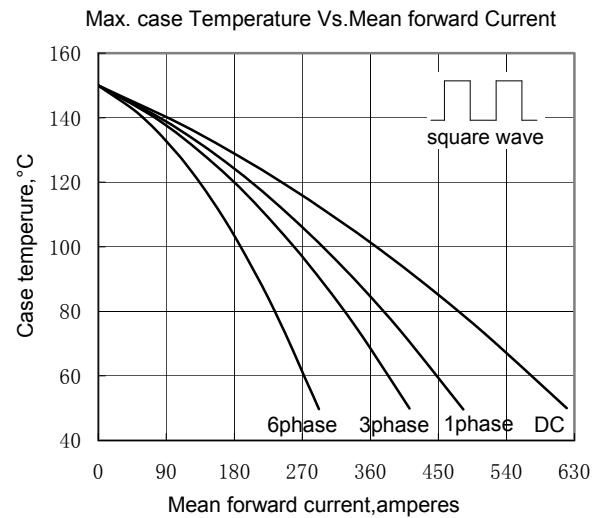

Fig.6

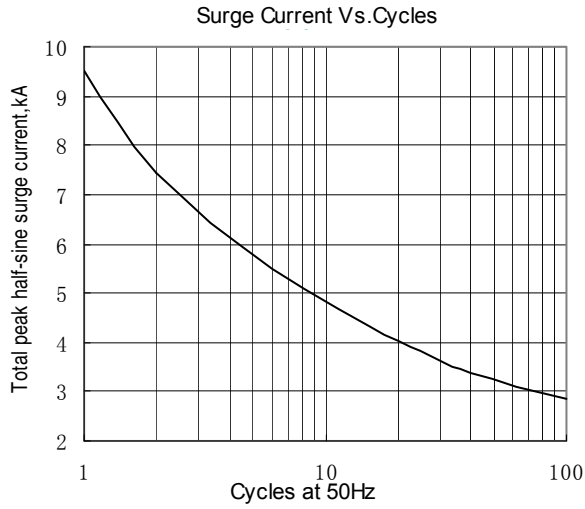

Fig.7

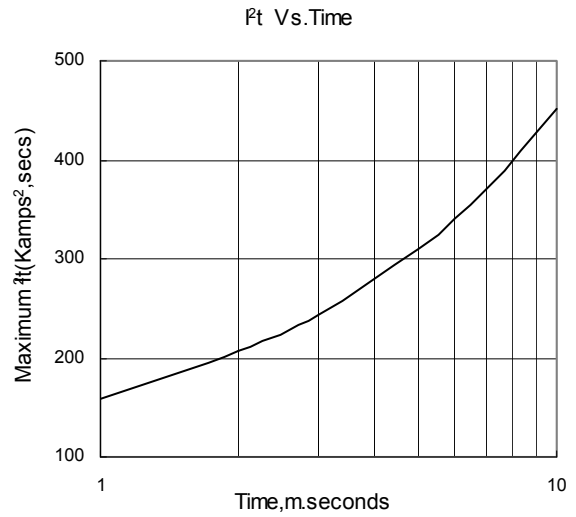
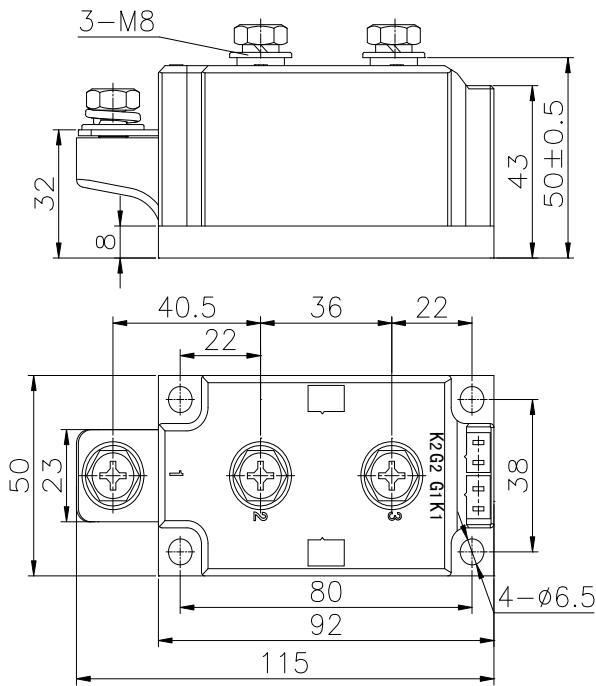

Fig.8

Outline:



413F3

