

### Features:

- Isolated mounting base 2500V~
- Pressure contact technology with Increased power cycling capability
- Space and weight savings

### Typical Applications

- AC/DC Motor drives
- Various rectifiers
- DC supply for PWM inverter

$I_{T(AV)}$             **600A**  
 $V_{DRM}/V_{RRM}$     **600~1800V**  
 $I_{TSM}$                 **16 A $\times 10^3$**   
 $I^2t$                     **1280A $^2$  S $\times 10^3$**



SYMBOL	CHARACTERISTIC	TEST CONDITIONS	T <sub>J</sub> (°C)	VALUE			UNIT
				Min	Type	Max	
$I_{T(AV)}$	Mean on-state current	180° half sine wave 50Hz Single side cooled, T <sub>c</sub> =85°C	125			600	A
$I_{T(RMS)}$	RMS on-state current		125			942	A
$V_{DRM}$ $V_{RRM}$	Repetitive peak off-state voltage Repetitive peak reverse voltage	$V_{DRM}$ & $V_{RRM}$ tp=10ms $V_{DSM}$ & $V_{RSM}$ = $V_{DRM}$ & $V_{RRM}$ +100V respectively	125	600		1800	V
$I_{DRM}$ $I_{RRM}$	Repetitive peak current	at $V_{DRM}$ at $V_{RRM}$	125			45	mA
$I_{TSM}$	Surge on-state current	10ms half sine wave	125			16	KA
$I^2t$	$I^2t$ for fusing coordination	$V_R=60\%V_{RRM}$				1280	A $^2$ s $\times 10^3$
$V_{TO}$	Threshold voltage		125			0.80	V
$r_T$	On-state slop resistance					0.28	mΩ
$V_{TM}$	Peak on-state voltage	$I_{TM}=1800A$	25			1.45	V
$dv/dt$	Critical rate of rise of off-state voltage	$V_{DM}=67\%V_{DRM}$	125			800	V/μs
$di/dt$	Critical rate of rise of on-state current	Gate source 1.5A $t_r \leq 0.5\mu s$ Repetitive	125			100	A/μs
$I_{GT}$	Gate trigger current	$V_A=12V, I_A=1A$	25	30		200	mA
$V_{GT}$	Gate trigger voltage			1.0		3.0	V
$I_H$	Holding current			20		200	mA
$V_{GD}$	Non-trigger gate voltage	$V_{DM}=67\%V_{DRM}$	125	0.2			V
$R_{th(j-c)}$	Thermal resistance Junction to case	Single side cooled				0.054	°C/W
$R_{th(c-h)}$	Thermal resistance case to heatsink	Single side cooled				0.024	°C/W
$V_{iso}$	Isolation voltage	50Hz, R.M.S, t=1min, I <sub>iso</sub> :1mA(MAX)		2500			V
$F_m$	Thermal connection torque(M10)				12.0		N·m
	Mounting torque(M6)				6.0		N·m
$T_{stg}$	Stored temperature			-40		125	°C
$W_t$	Weight				2300		g
<b>Outline</b>	408F3/410F3/433F2						

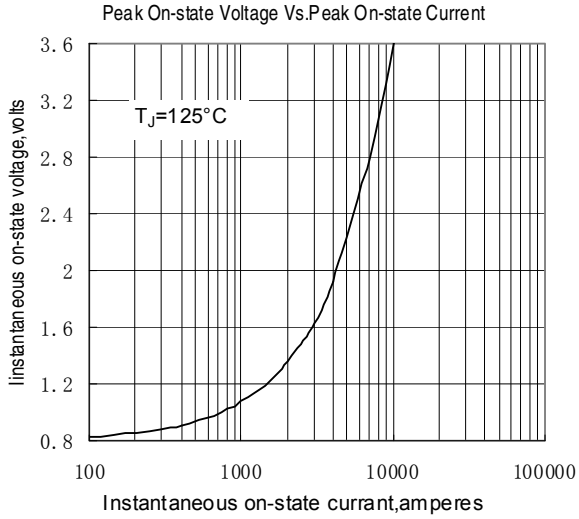

Fig.1

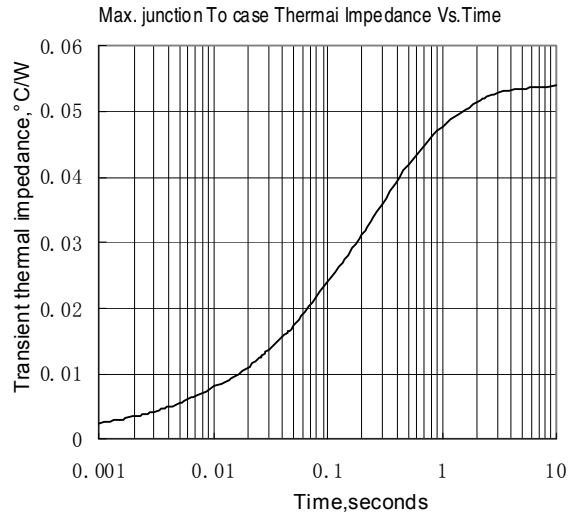

Fig.2

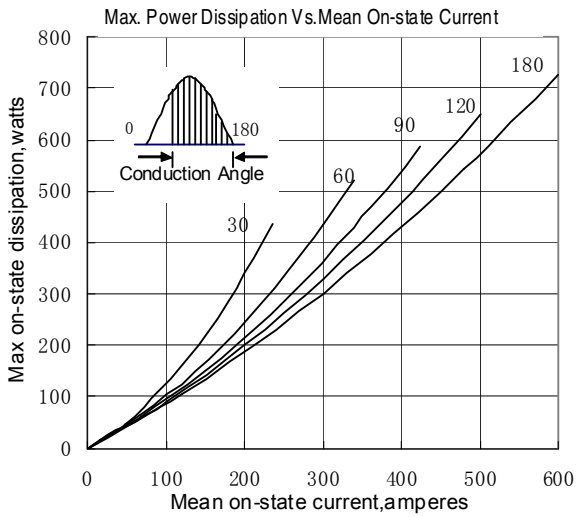

Fig.3

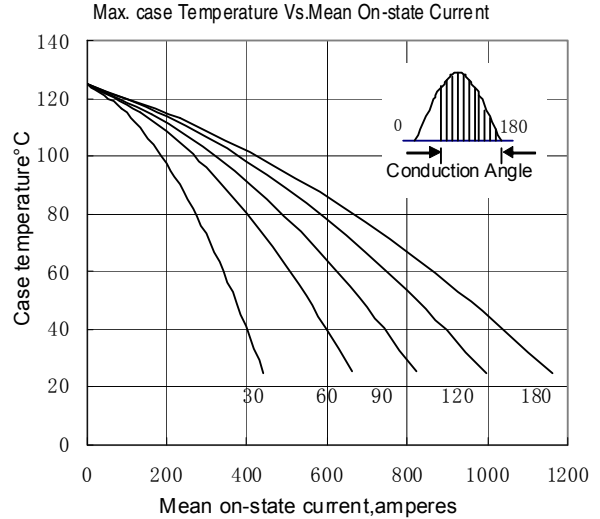

Fig.4

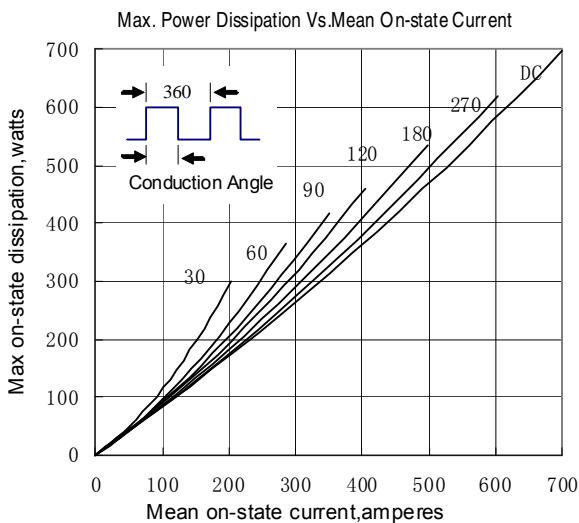

Fig.5

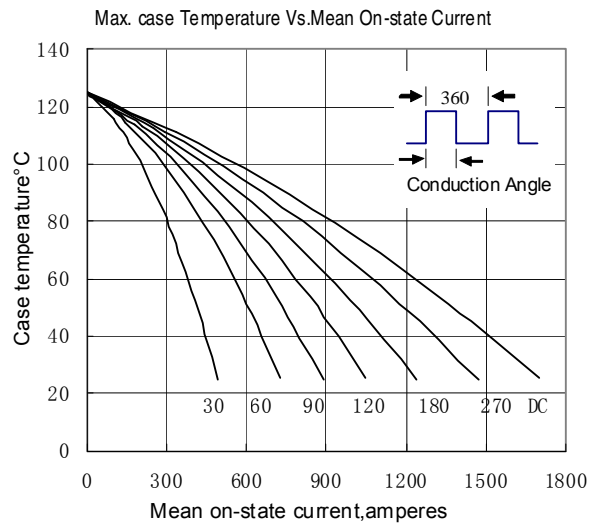

Fig.6

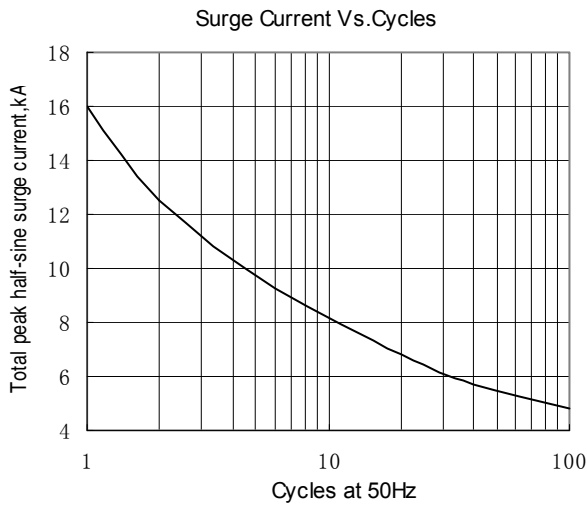

Fig.7

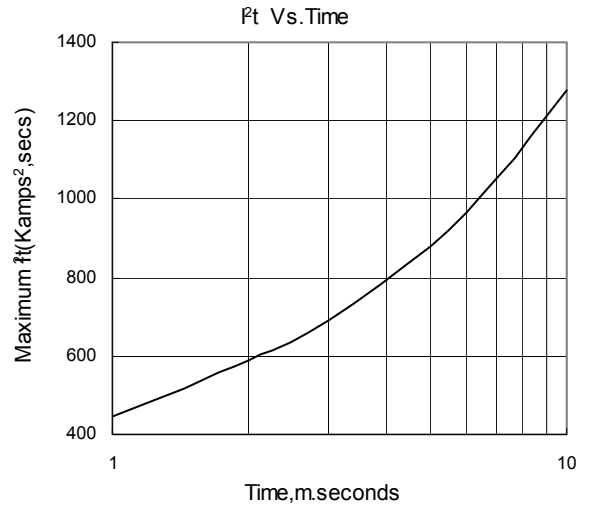

Fig.8

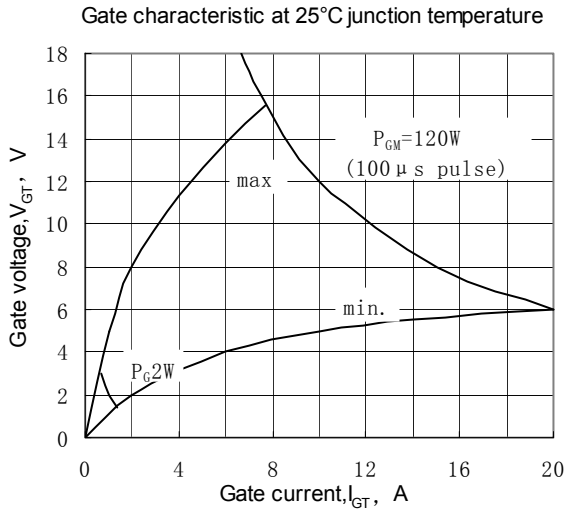

Fig.9

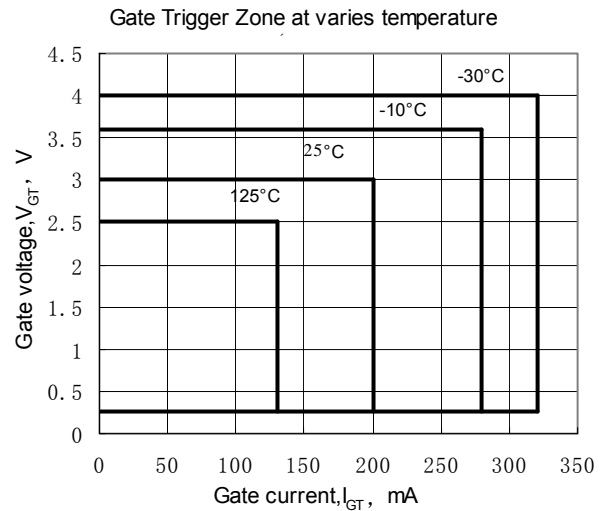
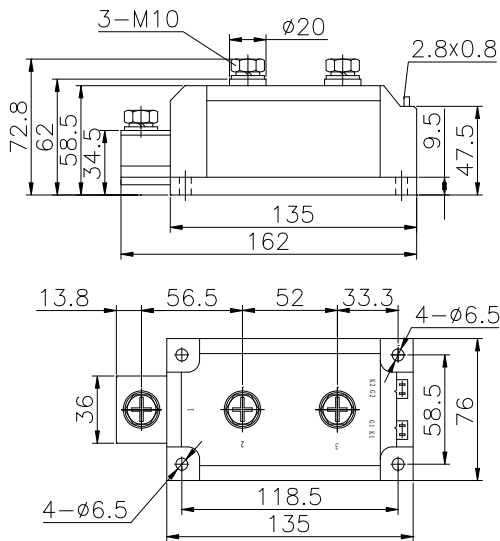

Fig.10

**Outline:**



**408F3**

