

Features:

- Isolated mounting base 2500V~
- Pressure contact technology with Increased power cycling capability
- Space and weight savings

Typical Applications

- AC/DC Motor drives
- Various rectifiers
- DC supply for PWM inverter

$I_{T(AV)}$ **350A**
 V_{DRM}/V_{RRM} **600~1800V**
 I_{TSM} **$11A \times 10^3$**
 I^2t **$605A^2 S \times 10^3$**



SYMBOL	CHARACTERISTIC	TEST CONDITIONS	T _J (°C)	VALUE			UNIT
				Min	Type	Max	
$I_{T(AV)}$	Mean on-state current	180° half sine wave 50Hz Single side cooled, T _c =85°C	125			350	A
$I_{T(RMS)}$	RMS on-state current		125			550	A
V_{DRM} V_{RRM}	Repetitive peak off-state voltage Repetitive peak reverse voltage	$V_{DRM} \& V_{RRM}$ tp=10ms $V_{DSM} \& V_{RSM} = V_{DRM} \& V_{RRM} + 100V$ respectively	125	600		1800	V
I_{DRM} I_{RRM}	Repetitive peak current	at V_{DRM} at V_{RRM}	125			35	mA
I_{TSM}	Surge on-state current	10ms half sine wave	125			11	KA
I^2t	I^2t for fusing coordination	$V_R = 60\% V_{RRM}$				605	$A^2s \times 10^3$
V_{TO}	Threshold voltage		125			0.95	V
r_T	On-state slop resistance					0.36	mΩ
V_{TM}	Peak on-state voltage	$I_{TM} = 1050A$	25			1.45	V
dv/dt	Critical rate of rise of off-state voltage	$V_{DM} = 67\% V_{DRM}$	125			800	V/μs
di/dt	Critical rate of rise of on-state current	Gate source 1.5A $t_r \leq 0.5\mu s$ Repetitive	125			100	A/μs
I_{GT}	Gate trigger current	$V_A = 12V, I_A = 1A$	25	30		180	mA
V_{GT}	Gate trigger voltage			1.0		2.5	V
I_H	Holding current			20		150	mA
V_{GD}	Non-trigger gate voltage	$V_{DM} = 67\% V_{DRM}$	125	0.2			V
$R_{th(j-c)}$	Thermal resistance Junction to case	Single side cooled				0.090	°C/W
$R_{th(c-h)}$	Thermal resistance case to heatsink	Single side cooled				0.04	°C/W
V_{iso}	Isolation voltage	50Hz, R.M.S, t=1min, I _{iso} :1mA(MAX)		2500			V
F_m	Thermal connection torque(M10)				12.0		N·m
	Mounting torque(M6)				6.0		N·m
T_{stg}	Stored temperature			-40		125	°C
W_t	Weight				1350		g
Outline	415F3/424F3						

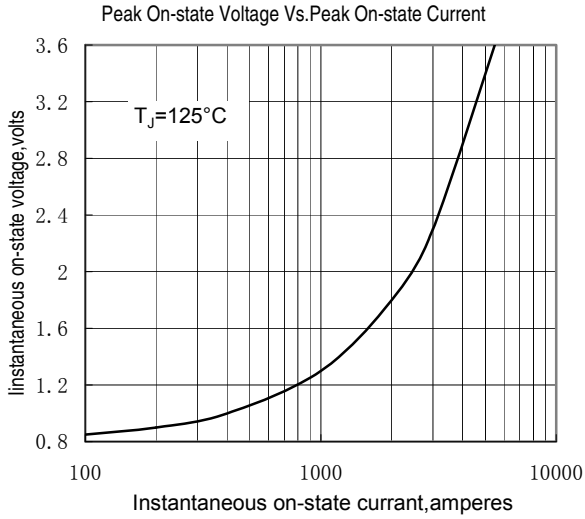

Fig.1

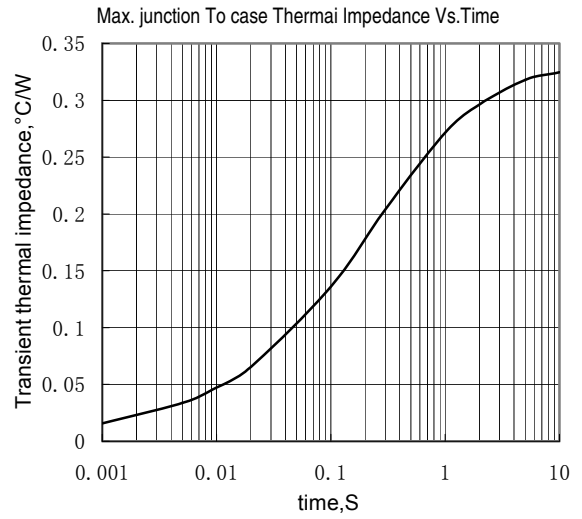

Fig.2

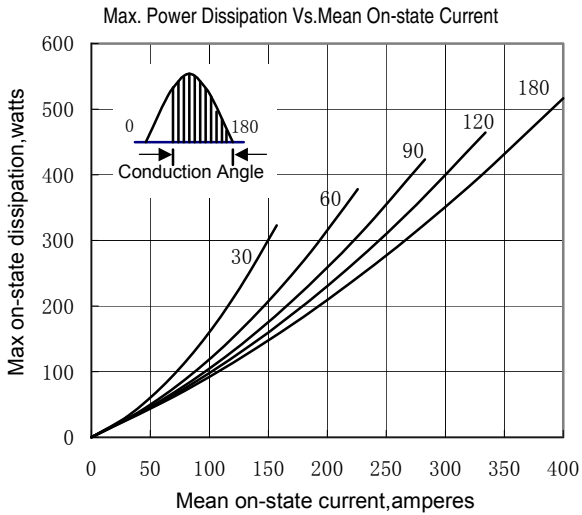

Fig.3

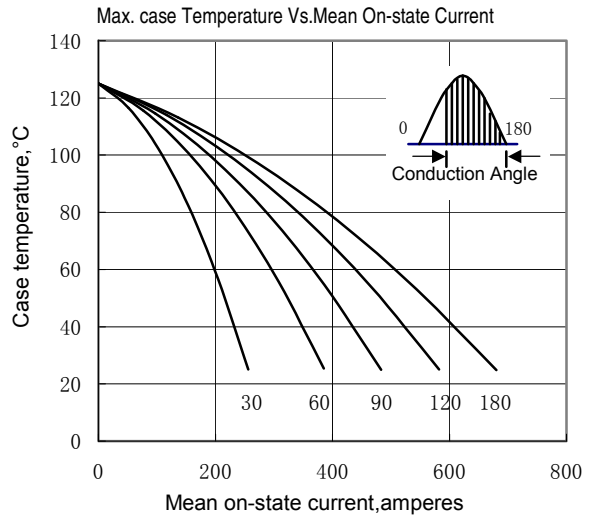

Fig.4

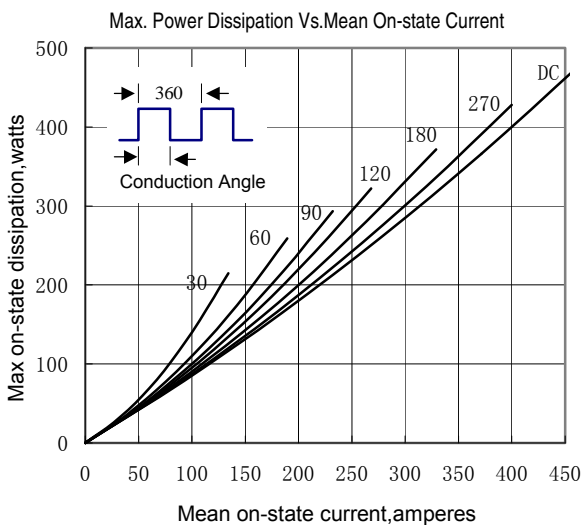

Fig.5

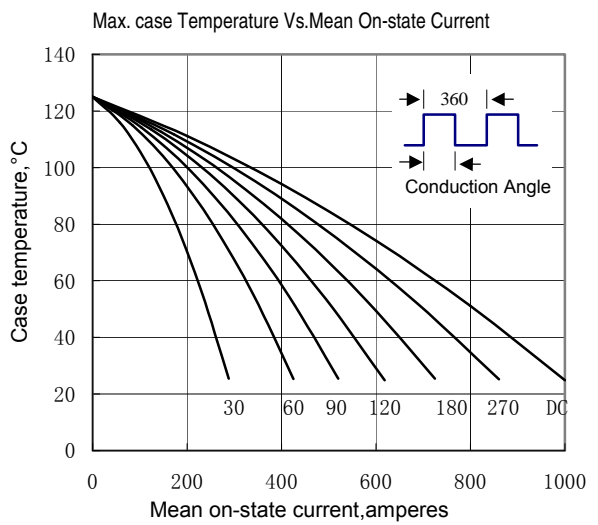

Fig.6

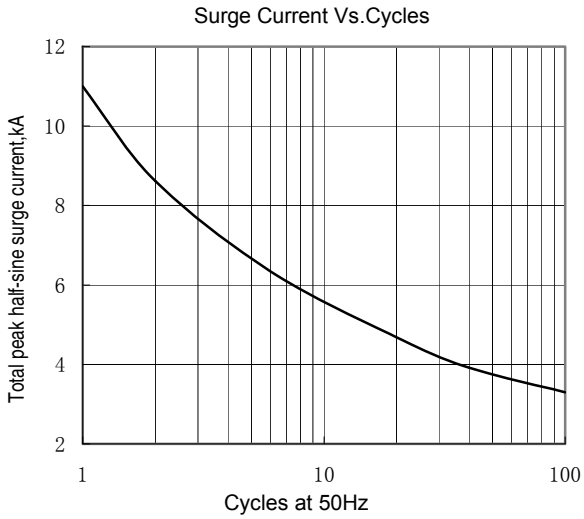

Fig.7

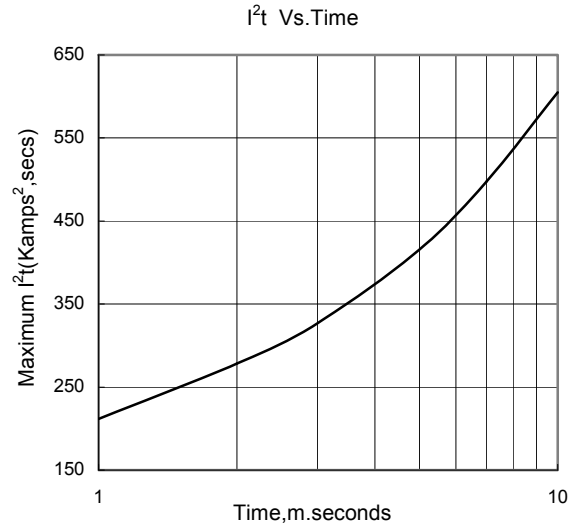

Fig.8

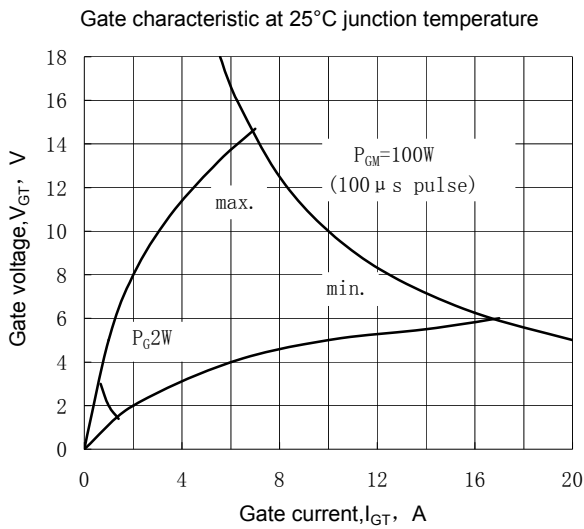

Fig.9

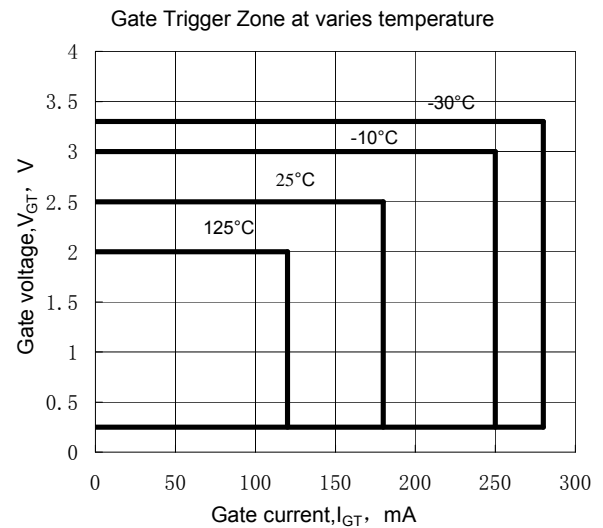
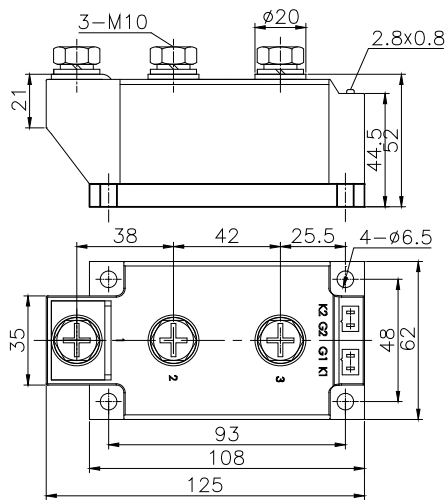

Fig.10

Outline:



415F3

