

Features:

- Isolated mounting base 2500V~
- Pressure contact technology with
Increased power cycling capability
- Space and weight savings

Typical Applications

- AC/DC Motor drives
- Various rectifiers
- DC supply for PWM inverter

$I_{T(AV)}$ **160A**
 V_{DRM}/V_{RRM} **600~1800V**
 I_{TSM} **$6.0A \times 10^3$**
 I^2t **$180A^2 S \cdot 10^3$**



SYMBOL	CHARACTERISTIC	TEST CONDITIONS	T _J (°C)	VALUE			UNIT
				Min	Type	Max	
$I_{T(AV)}$	Mean on-state current	180° half sine wave 50Hz Single side cooled, T _c =85°C	125			160	A
$I_{T(RMS)}$	RMS on-state current		125			251	A
V_{DRM} V_{RRM}	Repetitive peak off-state voltage Repetitive peak reverse voltage	V_{DRM} & V_{RRM} tp=10ms V_{DSM} & $V_{RSM} = V_{DRM}$ & $V_{RRM} + 100V$ respectively	125	600		1800	V
I_{DRM} I_{RRM}	Repetitive peak current	at V_{DRM} at V_{RRM}	125			15	mA
I_{TSM}	Surge on-state current	10ms half sine wave	125			6.0	KA
I^2t	I^2T for fusing coordination	$V_R = 60\% V_{RRM}$				180	$A^2s \cdot 10^3$
V_{TO}	Threshold voltage		125			0.8	V
r_T	On-state slop resistance					1.69	mΩ
V_{TM}	Peak on-state voltage	$I_{TM} = 480A$	25			1.70	V
dv/dt	Critical rate of rise of off-state voltage	$V_{DM} = 67\% V_{DRM}$	125			800	V/μs
di/dt	Critical rate of rise of on-state current	Gate source 1.5A $t_r \leq 0.5\mu s$ Repetitive	125			100	A/μs
I_{GT}	Gate trigger current		25	30		150	mA
V_{GT}	Gate trigger voltage	$V_A = 12V, I_A = 1A$		1.0		2.5	V
I_H	Holding current			20		150	mA
V_{GD}	Non-trigger gate voltage	$V_{DM} = 67\% V_{DRM}$	125	0.2			V
$R_{th(j-c)}$	Thermal resistance Junction to case	Single side cooled				0.170	°C/W
$R_{th(c-h)}$	Thermal resistance case to heatsink	Single side cooled				0.08	°C/W
V_{iso}	Isolation voltage	50Hz, R.M.S, t=1min, I _{iso} :1mA(MAX)		2500			V
F_m	Thermal connection torque(M5)					4.0	N·m
	Mounting torque(M6)					6.0	N·m
T_{stg}	Stored temperature			-40		125	°C
W_t	Weight					320	g
Outline	214F3/216F3						

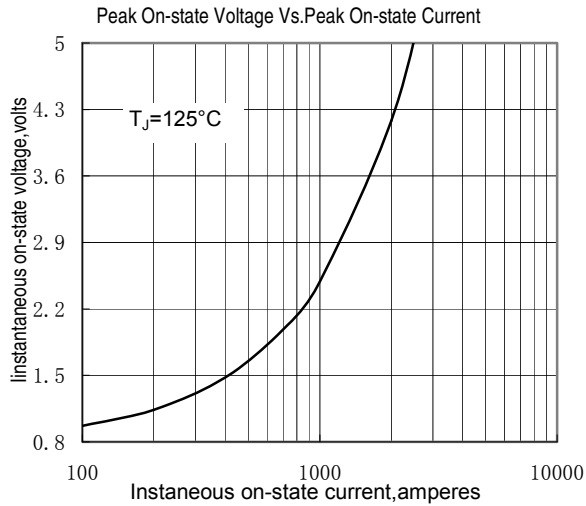

Fig.1

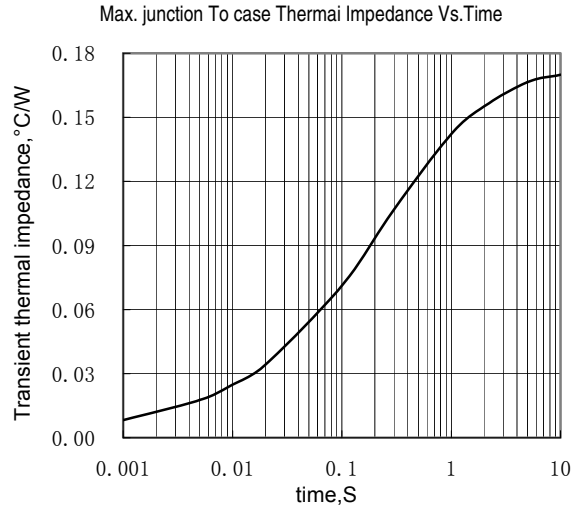

Fig.2

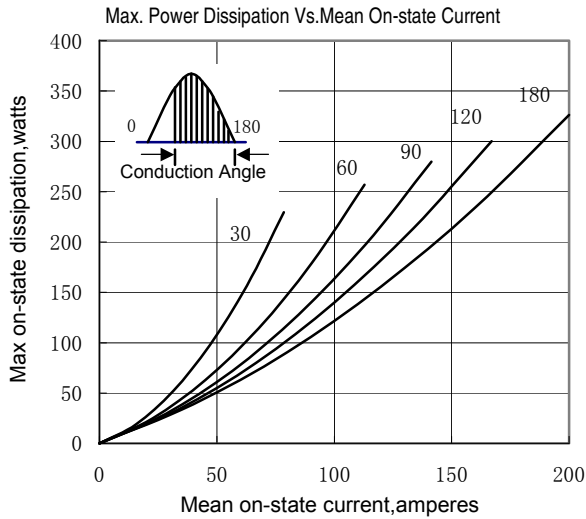

Fig.3

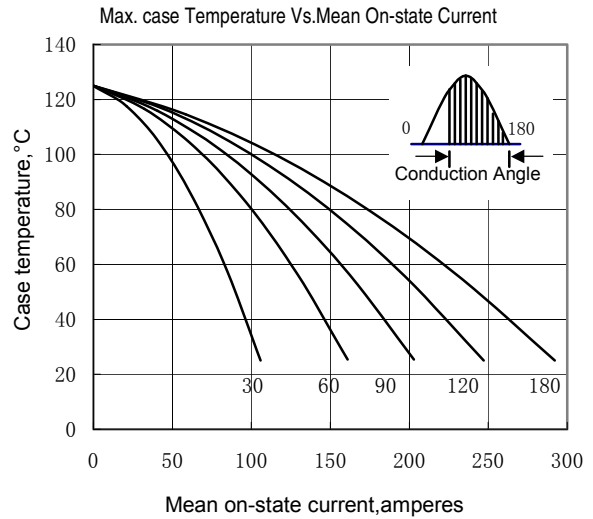

Fig.4

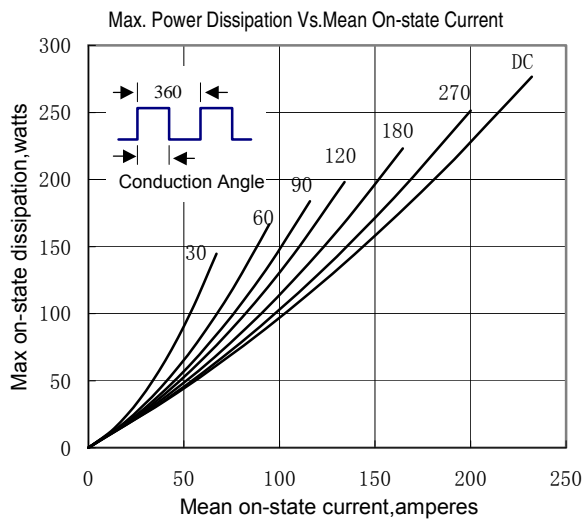

Fig.5

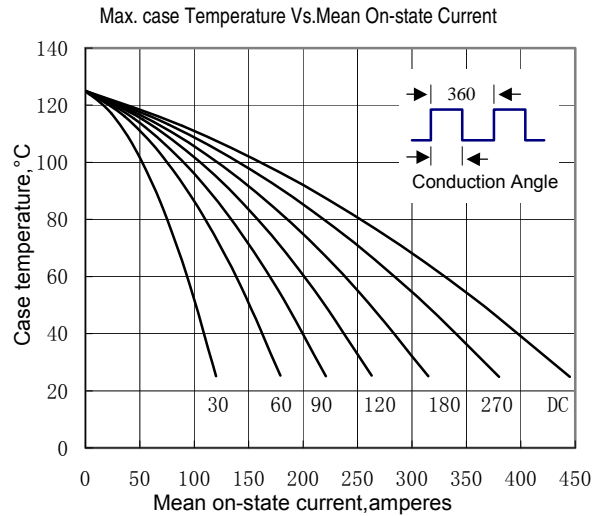

Fig.6

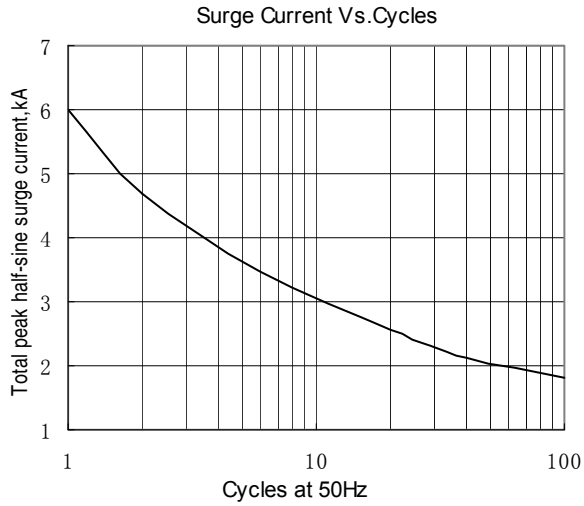

Fig.7

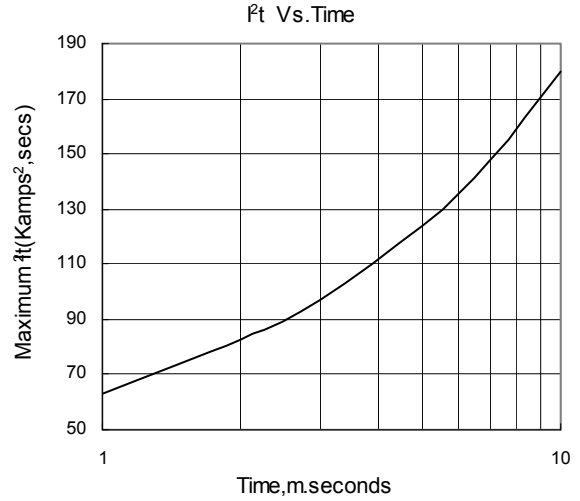

Fig.8

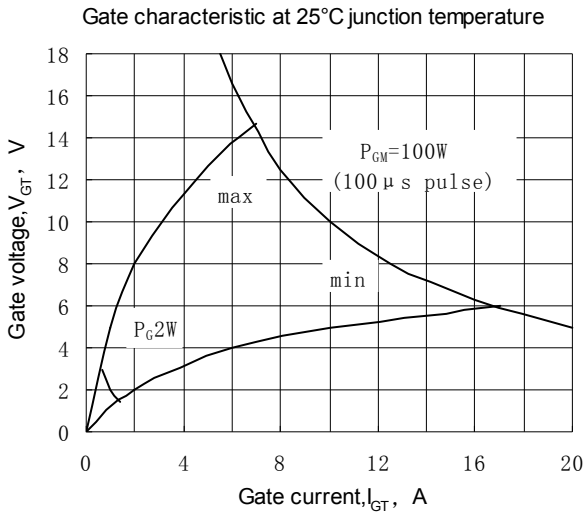

Fig.9

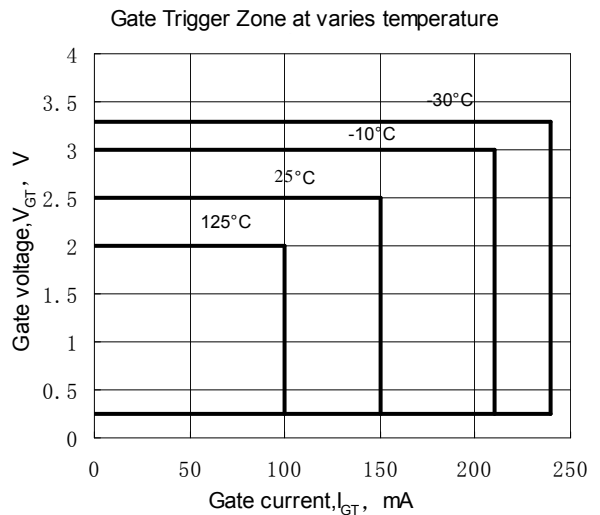
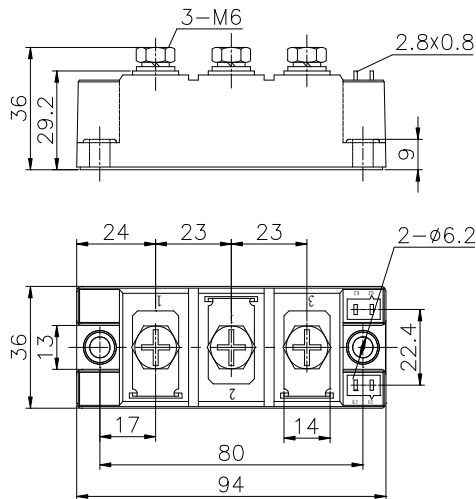

Fig.10

Outline:



214F3

