

CSP305A/600

Conduction-cooled capacitor

Technology Patented Worldwide

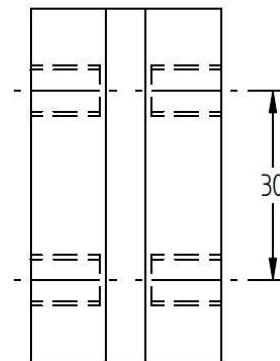
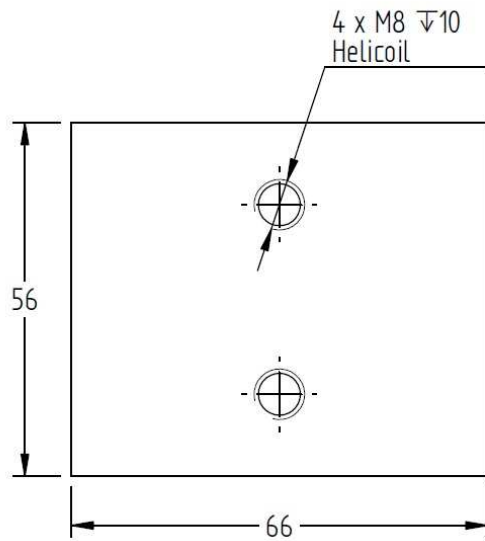

Specifications

Type		CSP305A/600							
Dimensions (L x W x H)	mm	66 x 56 x 30.2							
Weight	kg	0.5							
Capacitance ($\pm 10\%$)	μF	0.1 μF	0.2 μF	0.33 μF	0.66 μF	1 μF	1.33 μF	2.6 μF	5 μF
Sinusoidal Voltage	V _{rms}	1000			800	700	600	500	
Peak Voltage	V	1410			1130	990	850	710	
Max. Current	A _{rms}	600			750	900	950	1050	1200
Max. Power	kVA _r	600							
Freq Range @ Full Power	kHz	955-955	478-478	290-290	226-226	149-215	147-180	102-113	76-76
Stray Inductance	nH	< 3							

Celem Power Capacitors

Produced: 06-02-2014

CSP305A/600

Conduction-cooled capacitor

Technology Patented Worldwide

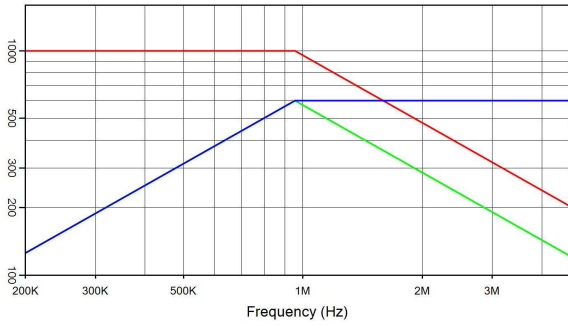

CSP305A/600 0.1 µF 1000 V_{rms} 600 A_{rms} 600 kVA_r
 I(A) — Q(kVA_r) — V_{rms}

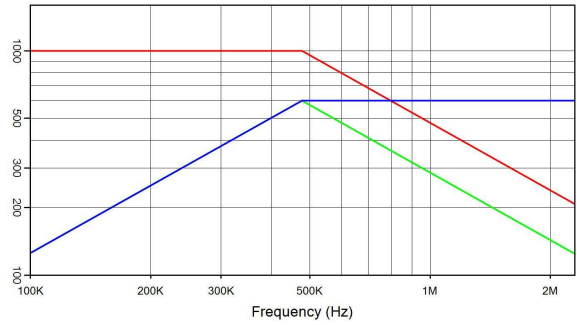

CSP305A/600 0.2 µF 1000 V_{rms} 600 A_{rms} 600 kVA_r
 I(A) — Q(kVA_r) — V_{rms}

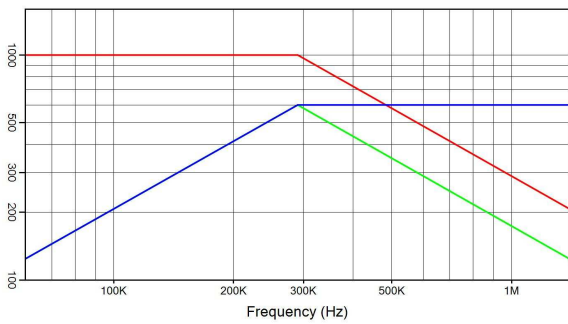

CSP305A/600 0.33 µF 1000 V_{rms} 600 A_{rms} 600 kVA_r
 I(A) — Q(kVA_r) — V_{rms}

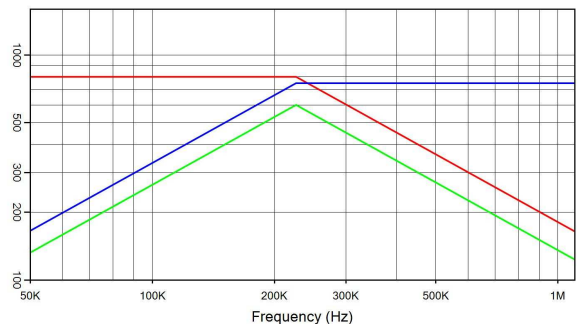

CSP305A/600 0.66 µF 800 V_{rms} 750 A_{rms} 600 kVA_r
 I(A) — Q(kVA_r) — V_{rms}

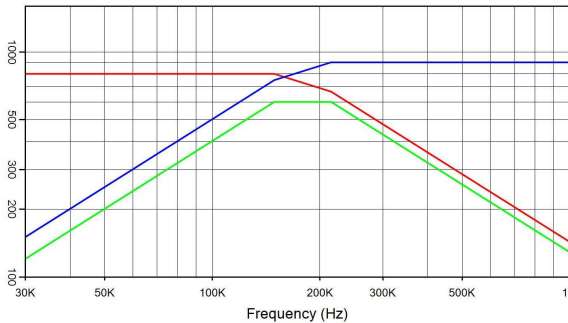

CSP305A/600 1 µF 800 V_{rms} 900 A_{rms} 600 kVA_r
 I(A) — Q(kVA_r) — V_{rms}

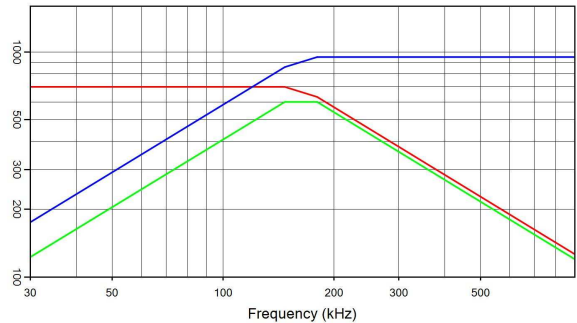

CSP305A/600 1.33 µF 700 V_{rms} 950 A_{rms} 600 kVA_r
 I(A) — Q(kVA_r) — V_{rms}

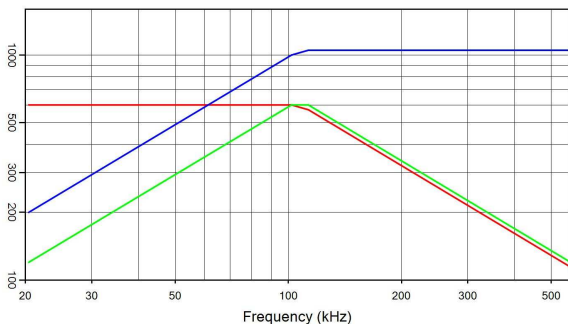

CSP305A/600 2.6 µF 600 V_{rms} 1050 A_{rms} 600 kVA_r
 I(A) — Q(kVA_r) — V_{rms}

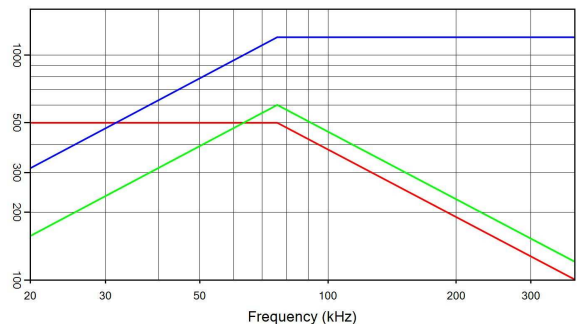

CSP305A/600 5 µF 500 V_{rms} 1200 A_{rms} 600 kVA_r
 I(A) — Q(kVA_r) — V_{rms}

Celem Power Capacitors

Produced: 06-02-2014