

CSP 180 / 300

Conduction-cooled capacitor

Technology Patented Worldwide

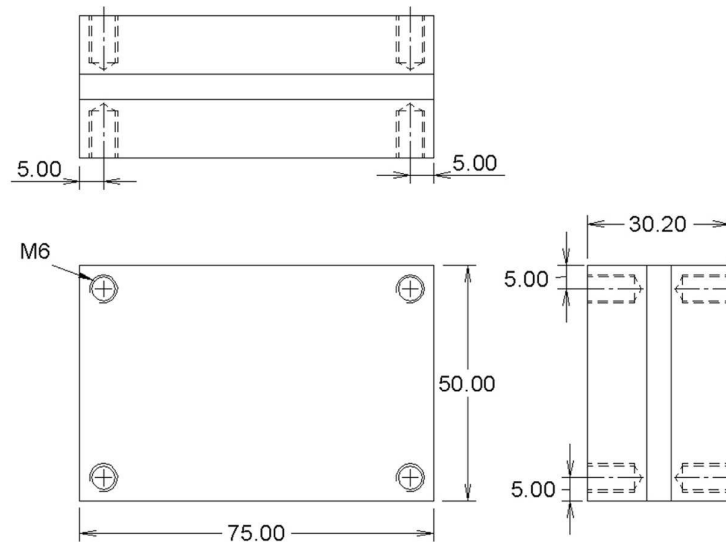

The new CSP 180/300 conduction-cooled capacitor is a 300kVAr version of the 180kVAr CSP 180. It can be mounted only between 2 parallel plates.

Specifications

TYPE		CSP 180 / 300							
Dimensions (L x W x H)	mm	75 x 50 x 30.2							
Weight	kg	0.5							
Capacitance ($\pm 10\%$)	μF	0.1	0.2	0.33	0.66	1	1.3	2.6	5
Sinusoidal Voltage	V_{rms}	1000		700		600		500	400
Peak Voltage	\hat{V}	1410		990		850		710	570
Max. Current	A_{rms}	350	400	500		650		800	
Max. Power	kVA _r	300							
Freq Range @ Full Power	kHz	477-650	239-424	295-402	148-201	133-224	102-172	73-86	60-68
Stray Inductance	nH	< 5							
Freq Limit	kHz	700							

CSP 180 / 300

Conduction-cooled capacitor

Technology Patented Worldwide

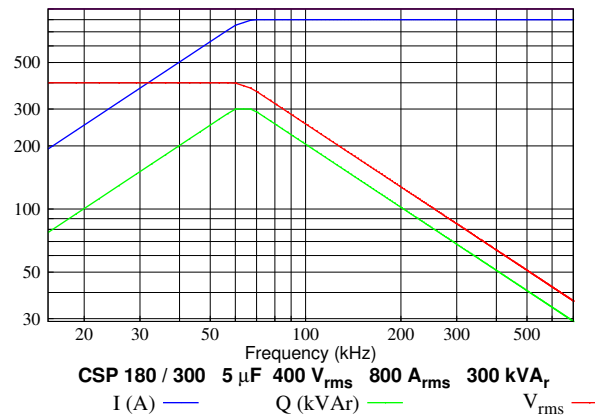
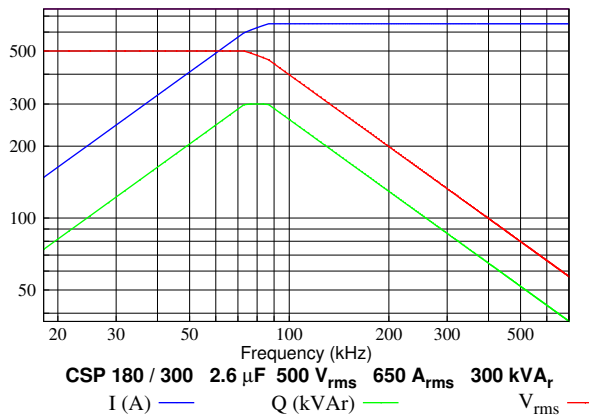
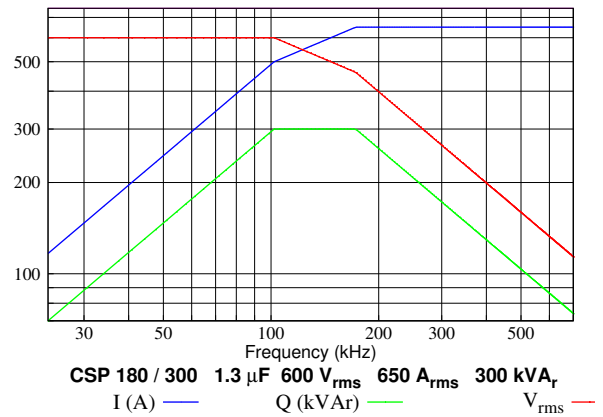
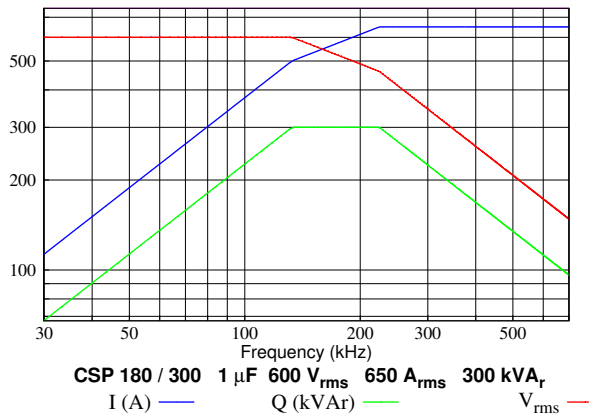
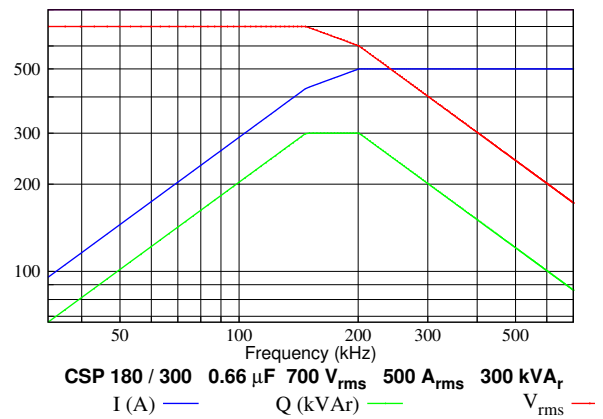
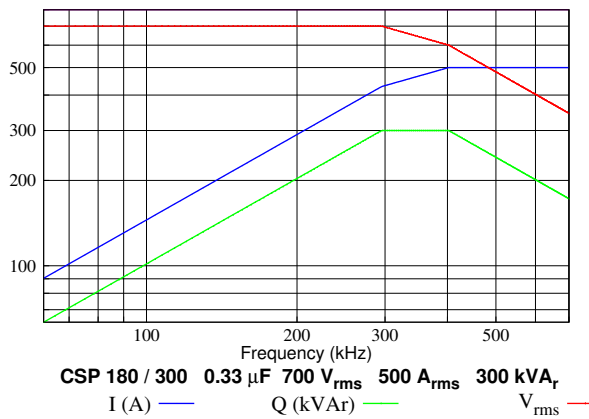
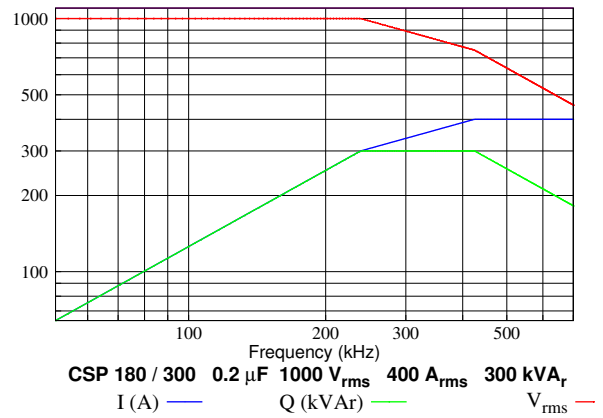
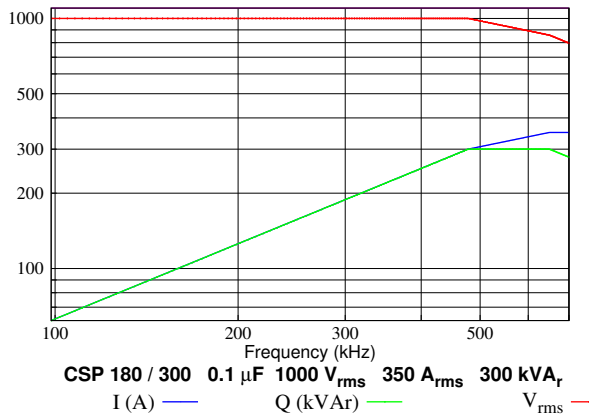

Celem Power Capacitors

Produced: August 3, 2009