

CPRI 400 New

Conduction-cooled capacitor

Technology Patented Worldwide

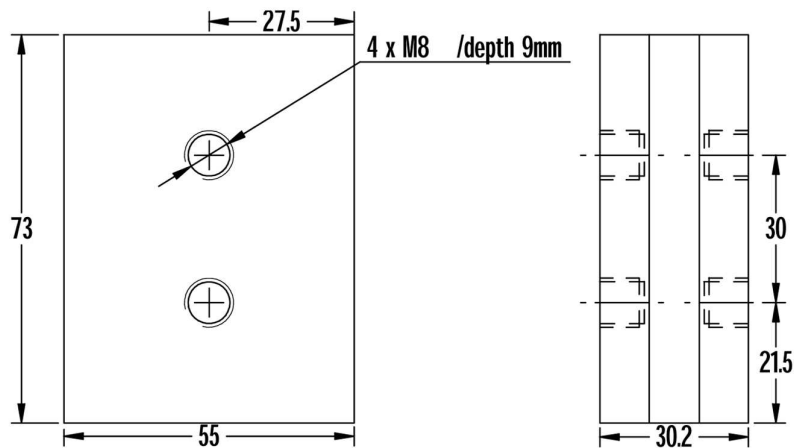

With up to 400kVAr, CPRI 400New conduction-cooled capacitor is widely used for high power, low volume configurations for capacitances under 2 μ F.

Specifications

TYPE		CPRI 400 New									
Dimensions (L x W x H)	mm	73 x 55 x 30.2									
Weight	kg	0.5									
Capacitance ($\pm 10\%$)	μ F	0.15	0.2	0.25	0.3	0.5	1	1.3	1.5	1.7	2
Sinusoidal Voltage	V_{rms}	1000				700		500			
Peak Voltage	\hat{V}	1410				990		710			
Max. Current	A_{rms}	450			600			750		800	
Max. Power	kVA _r	400						350			
Freq Range @ Full Power	kHz	424-537	318-403	255-322	212-477	260-286	130-224	171-197	149-171	131-171	111-146
Stray Inductance	nH	< 5									
Freq Limit	kHz	700									

CPRI 400 New

Conduction-cooled capacitor

Technology Patented Worldwide

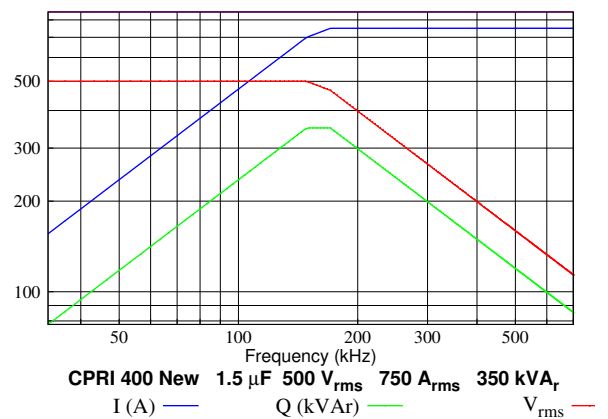
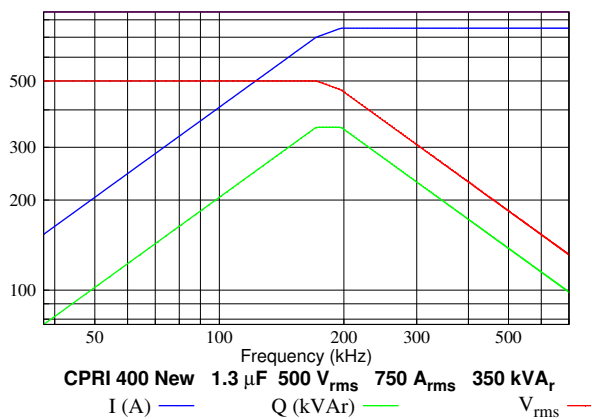
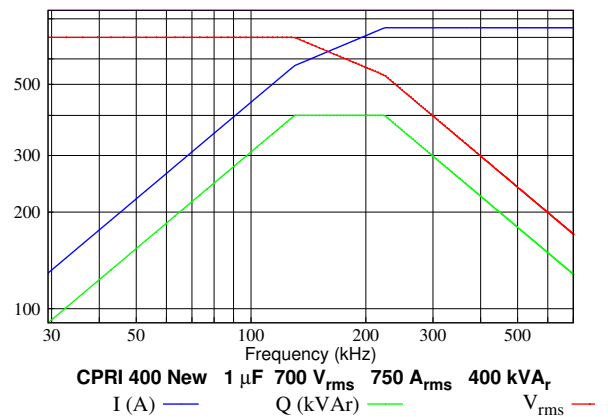
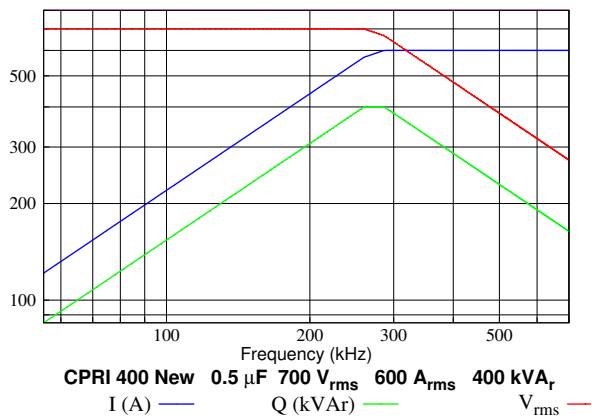
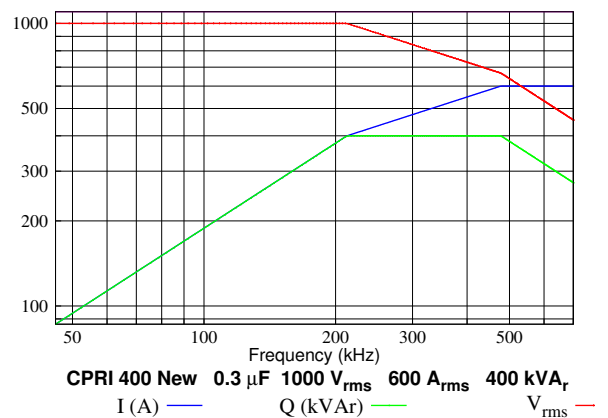
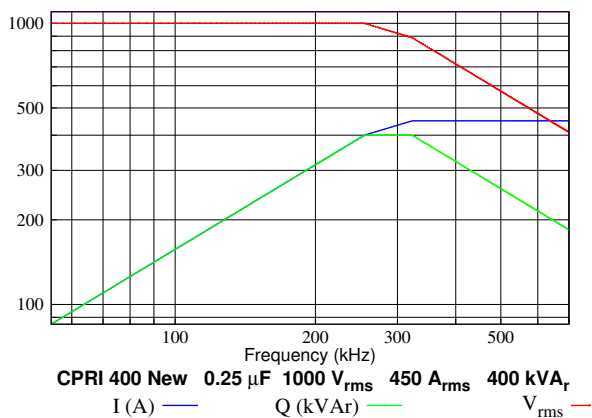
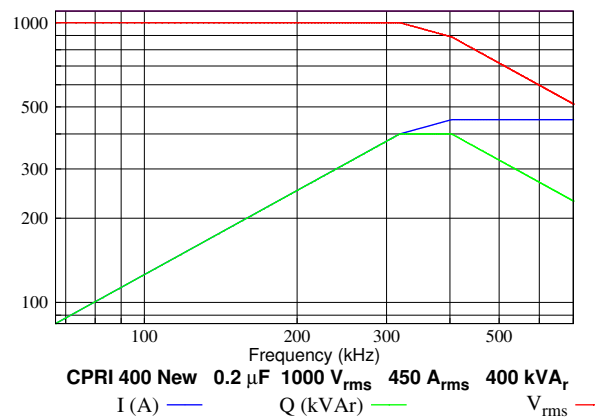
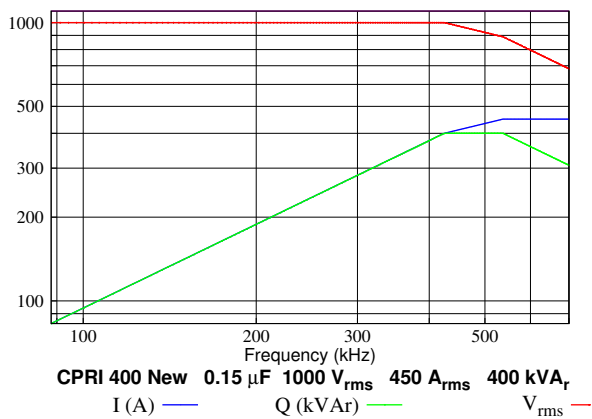

CPRI 400 New

Conduction-cooled capacitor

Technology Patented Worldwide

