

# High-Temperature Silicon Carbide (SiC) Half-Bridge Power Module

## N-Channel MOSFET Version

**1200 V / 225 A / 13.5 mΩ**

### FEATURES

- High temperature:  $T_{c(max)} = 225\text{ °C}$   
 $T_{J(max)} = 225\text{ °C}$
- AS9100:Rev. C-certified manufacturing, traceable throughout value chain
- Ultra-fast switching (<30 ns), low inductance
- Enables high system efficiency
- Low profile, small form factor

### APPLICATIONS

- High-efficiency converters / inverters
- Motor drives
- Aerospace: Military & Commercial
- Smart grid/grid-tie distributed generation
- Industrial and automotive traction drives

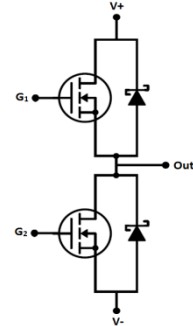

### DESCRIPTION

The APE HT-2102-A Silicon Carbide (SiC) half-bridge power module was designed specifically to address the growing demand for higher power densities, higher temperatures, and higher switching frequencies.

### COMPANION PARTS

Maximum performance may be obtained through use of the companion high-temperature gate driver, part number APE MTGD2-2011, designed especially for driving the Silicon Carbide module.

### Power Module Absolute Maximum Ratings ( $T_c = 25\text{ °C}$ unless otherwise specified)

Symbol	Parameter	Condition(s)	Value	Units
$V_{DSS}$	Drain-source voltage		1200	V
$V_{GSS}$	Gate-source voltage		-5 to 20	V
$I_D$	Continuous drain current	$T_c = 25\text{ °C}$	225	A
		$T_c = 100\text{ °C}$	175	
		$T_c = 200\text{ °C}$	80	
$I_{DM}$	Peak pulsed drain current	Pulse width $\leq 10\text{ }\mu\text{s}$ , duty cycle $\leq 2\%$	TBD	A
$P_D$	Maximum power dissipated		1600	W
$T_{C(max)}$	Maximum case temperature <sup>1</sup>		225	°C
$T_{J(min)}$	Minimum operating junction temperature		- 50	°C
$T_{J(max)}$	Maximum operating junction temperature		225	
$T_{stg}$	Storage temperature		- 50 to 225	°C
$V_{isol}$	Insulation test voltage	AC, 1 min.	TBD	V
		AC, 1 s.	TBD	

<sup>1</sup>The packaging materials have been qualified at this temperature.

Switch Position Electrical Characteristics ( $T_c = 25\text{ }^\circ\text{C}$ unless otherwise specified)						
Symbols	Parameter	Condition(s)	Values			Units
			Min.	Typical	Max.	
$V_{(BR)DSS}$	Drain-source breakdown voltage	$V_{GS} = 0\text{ V}, I_D = 1\text{ mA}$	1200	-	-	V
$V_{GS(th)}$	Gate-source threshold voltage	$V_{DS} = V_{GS}, I_D = 1\text{ mA}$	-	2.1	-	V
		$V_{DS} = V_{GS}, I_D = 1\text{ mA}, T_j = 205\text{ }^\circ\text{C}$	-	1.1	-	
$I_{DSS}$	Drain-source leakage current	$V_{GS} = -5\text{ V}, V_{DS} = 1200\text{ V}$	-	-	200	$\mu\text{A}$
		$V_{GS} = -5\text{ V}, V_{DS} = 1200\text{ V}, T_j = 205\text{ }^\circ\text{C}$	-	-	2000	
$I_{GSS}$	Gate-source leakage current	$V_{GS} = 20\text{ V}, V_{DS} = 0\text{ V}$	-	-	250	nA
$R_{DS(on)}$	Drain-source turn-on resistance	$V_{GS} = 20\text{ V}, I_D = 75\text{ A}$	-	13.5	-	m $\Omega$
		$V_{GS} = 20\text{ V}, I_D = 75\text{ A}, T_j = 225\text{ }^\circ\text{C}$	-	26.6	-	
$C_{iss}$	Input capacitance	$V_{GS} = 0\text{ V}$	-	11,490	-	pF
$C_{oss}$	Output capacitance	$V_{DS} = 800\text{ V}$	-	720	-	
$C_{rss}$	Reverse transfer capacitance	$f = 1\text{ MHz}$	-	78	-	
$t_{d(on)}$	Turn-on delay time	$V_{DD} = 600\text{ V}, V_{GS} = -4\text{ to }20\text{ V}$ $I_D = 120\text{ A}$ $R_{G(ext)} = 0\text{ }\Omega, R_L = 60\text{ }\Omega$	-	36	-	ns
$t_{rv}$	Rise time		-	20	-	
$t_{d(off)}$	Turn-off delay time		-	68	-	
$t_{fv}$	Fall time		-	25	-	

Switch Position Gate Charge Electrical Characteristics ( $T_c = 25\text{ }^\circ\text{C}$ unless otherwise specified)						
Symbols	Parameter	Condition(s)	Values			Units
			Min.	Typical	Max.	
$Q_{gs}$	Gate to source charge	$V_{DD} = 800\text{ V}, V_{GS} = -4\text{ to }20\text{ V}$ $I_D = 120\text{ A}$	-	143	-	nC
$Q_{gd}$	Gate to drain charge		-	260	-	
$Q_g$	Gate charge total		-	545	-	

Diode Position Electrical Characteristics ( $T_c = 25\text{ }^\circ\text{C}$ unless otherwise specified)						
Symbols	Parameter	Condition(s)	Values			Units
			Min.	Typical	Max.	
$V_{FM}$	Forward voltage	$I_F = 60\text{ A}$	-	1.65	-	V
		$I_F = 60\text{ A}, T_j = 200\text{ }^\circ\text{C}$	-	2.5	-	
$I_R$	Reverse current	$V_R = 1200\text{ V}$	-	TBD	-	$\mu\text{A}$
		$V_R = 1200\text{ V}, T_j = 200\text{ }^\circ\text{C}$	-	TBD	-	
$Q_C$	Capacitive charge	$V_R = 1200\text{ V}, I_F = 120\text{ A}, di/dt = 7500\text{ A}/\mu\text{s}$	-	780	-	nC

Thermal Characteristics ( $T_j = 25\text{ }^\circ\text{C}$ unless otherwise specified)						
Symbols	Parameter	Condition(s)	Values			Units
			Min.	Typical	Max.	
$R_{\theta(j-c)}$	FET thermal resistance junction-case			0.125		$^\circ\text{C}/\text{W}$

**Power Module Mechanical Characteristics**

Symbols	Parameter	Condition(s)	Values			Units
			Min.	Typical	Max.	
w	Weight			140		g
M <sub>s</sub>	Lead frame mounting torque	6-32 steel screw for lead frame, 10-32 steel screw for baseplate		40		in·lb

**TYPICAL PERFORMANCE CURVES**

 Fig. 1 - Typical Output Characteristics,  $T_j = 25^\circ\text{C}$ 

 Fig. 2 - Typical Output Characteristics,  $T_j = 205^\circ\text{C}$ 

Fig. 3 - Transconductance

 Fig. 4 - Typical On Resistance,  $V_{GS} = 20\text{ V}$ 

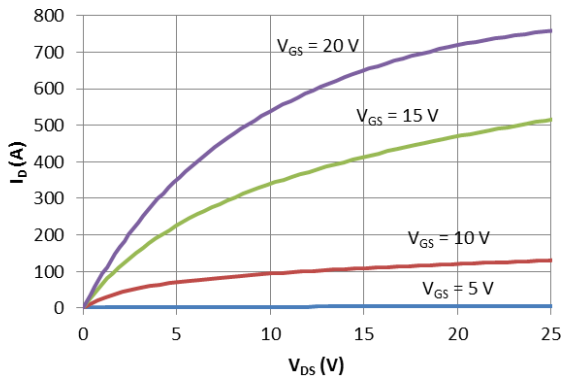
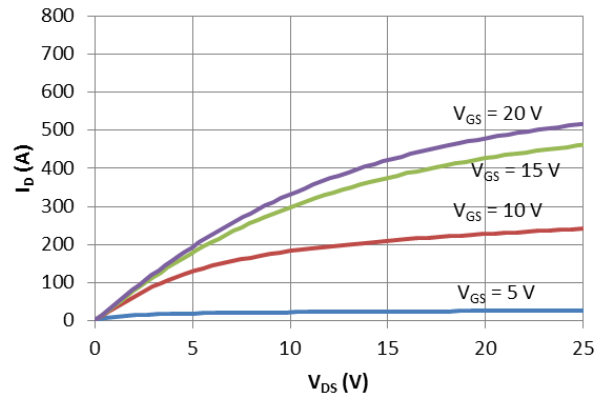
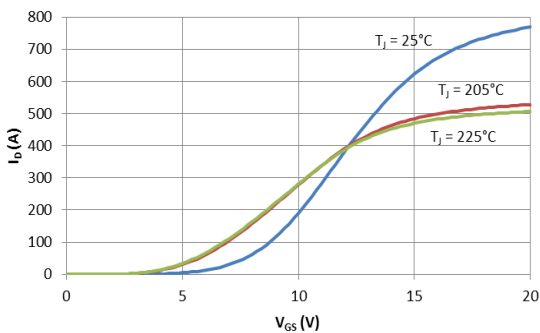
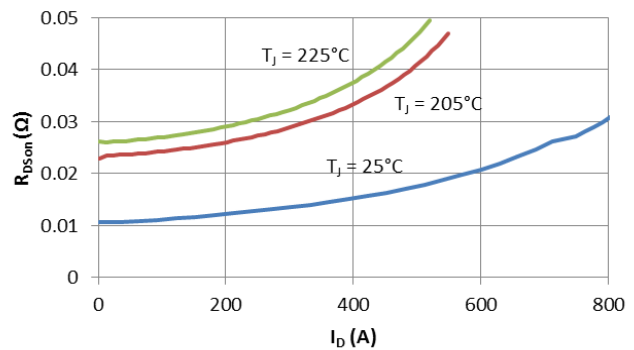
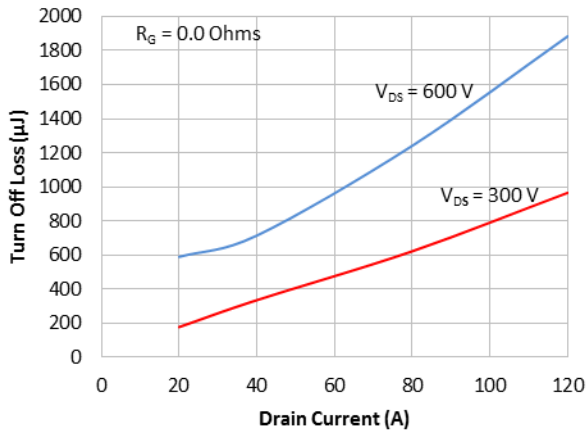



Fig. 5 – Turn off loss versus drain current

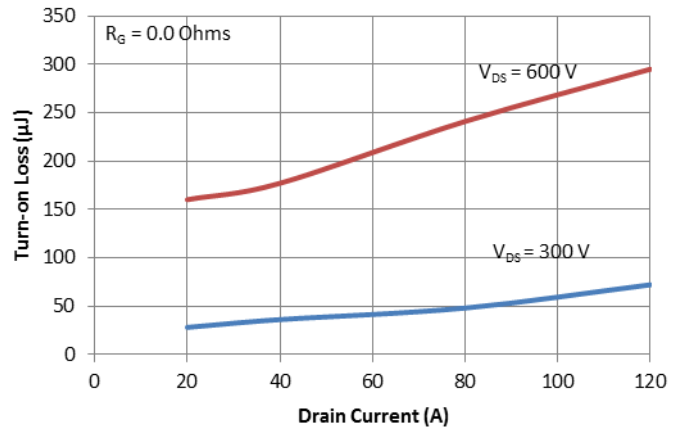

Fig. 6 – Turn on loss versus drain current

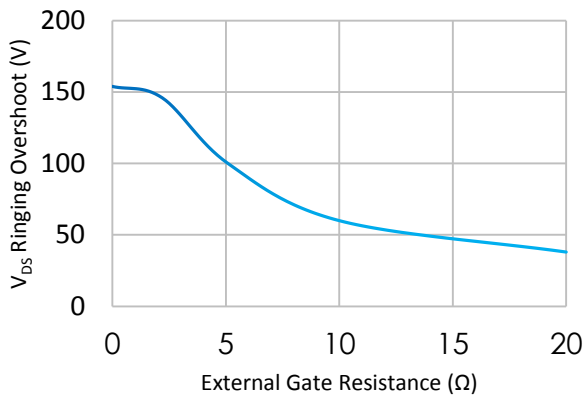

Fig. 7 – Ringing voltage overshoot versus external gate resistance

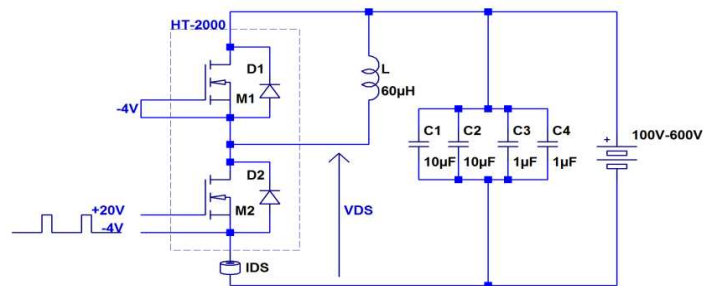
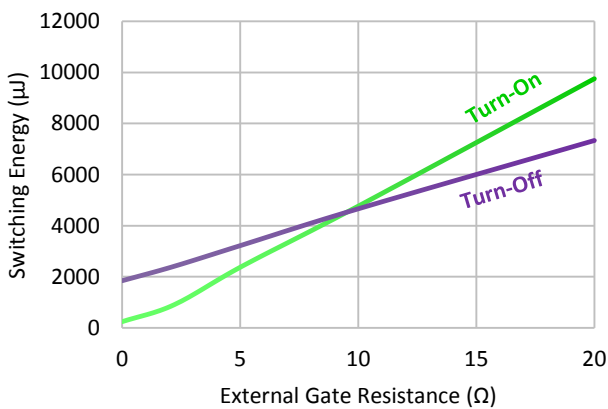

 Fig. 8 – Energy values obtained using companion gate driver ( $T_{amb} = 25\text{ }^{\circ}\text{C}$ ).

Fig. 9 – Switching energy versus external gate resistance

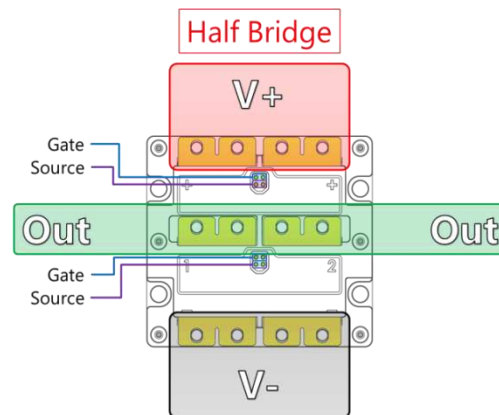

Fig 10 – Half Bridge Connection

**MOUNTING DIMENSIONS**

All dimensions are listed in inches

#10-32 bolts are recommended for mounting

A torque of 40 in·lb is recommended

CAD models are available upon request

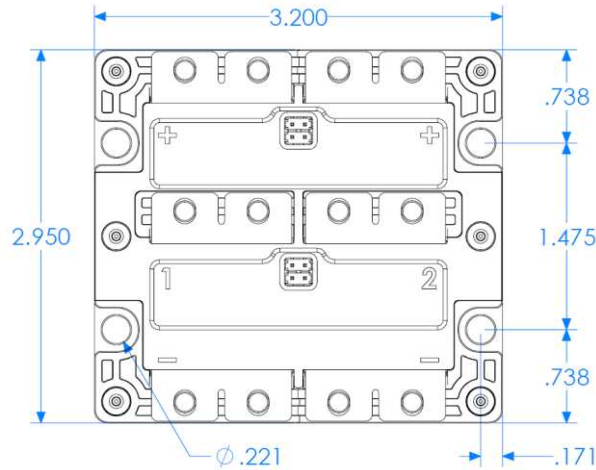

**POWER CONTACT DIMENSIONS**

All dimensions are listed in inches

#6-32 bolts required for the power contacts

A torque of 40 in·lb is recommended

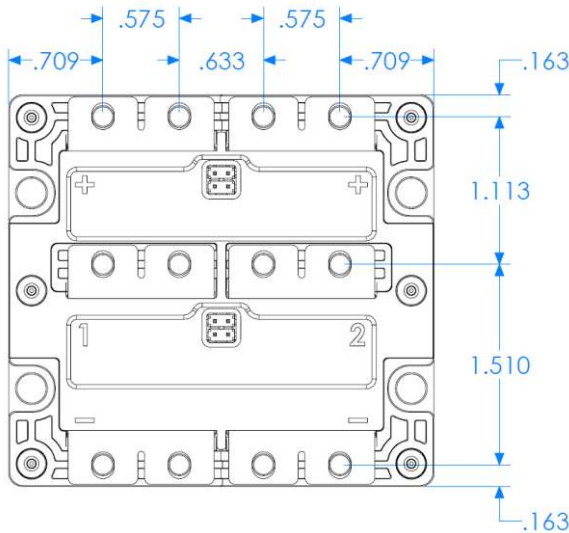
CAD models are available upon request

**GATE DRIVE CONNECTIONS**

All dimensions are listed in inches

CAD models are available upon request

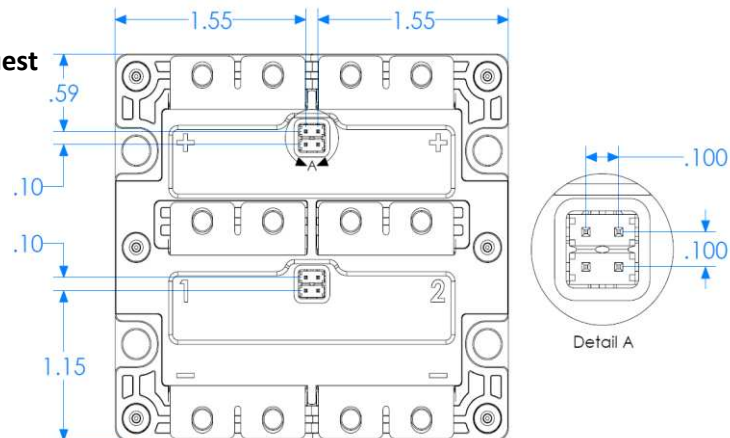



**PRELIMINARY**

**APE HT-2102-A**

**DISCLAIMER**

ALL PRODUCT, PRODUCT SPECIFICATIONS AND DATA ARE SUBJECT TO CHANGE WITHOUT NOTICE TO IMPROVE RELIABILITY, FUNCTION, DESIGN OR OTHERWISE.

Arkansas Power Electronics International, Inc., its affiliates, agents, and employees, and all persons acting on its or their behalf (collectively, "APEI"), disclaim any and all liability for any errors, inaccuracies or incompleteness contained in any datasheet or in any other disclosure relating to any product.

All product data sheets, product manuals and any other product related documentation, and all APEI products, courtesy samples and services are subject to APEI's Standard Terms and Conditions available online at <http://www.apei.net/termsandconditions.pdf>.

**ALL APEI PRODUCTS, PROTOTYPES AND ANY OTHER DEVICES MADE BY APEI SHALL BE TREATED AS ENGINEERING SAMPLES AND AS SUCH APEI DOES NOT ACCEPT ANY PRODUCT LIABILITY, CLAIMS OR DAMAGES OR FUTURE OBLIGATIONS TO SUPPLY. THE CONTENTS DISCLOSED IN ANY DATASHEET AND ALL OF APEI'S PRODUCTS, PROTOTYPES AND OTHER DEVICES SOLD OR PROVIDED BY APEI ARE "AS-IS" WITH NO WARRANTY OF ANY KIND, EITHER EXPRESS OR IMPLIED. APEI DOES NOT WARRANT THAT ITS ENGINEERING SAMPLES ARE FULLY VERIFIED, TESTED, OR WILL OPERATE IN ACCORDANCE WITH ANY DATA SHEET SPECIFICATIONS. APEI DISCLAIMS ANY OBLIGATIONS FOR TECHNICAL SUPPORT AND BUG FIXES. APEI SHALL NOT BE LIABLE FOR ANY DAMAGES, INCLUDING WITHOUT LIMITATION DIRECT, INDIRECT, INCIDENTAL, SPECIAL, RELIANCE, PUNITIVE, STATUTORY OR CONSEQUENTIAL DAMAGES ARISING FROM OR IN CONNECTION WITH THE CONTENTS OF ANY PRODUCT DATASHEET OR THE USE, INSTALLATION, OR IMPLEMENTATION OF ENGINEERING SAMPLES IN ANY MANNER WHATSOEVER, EVEN IF SELLER HAS BEEN ADVISED OF THE POSSIBILITY THEREOF. APEI MAKES NO REPRESENTATION THAT ITS ENGINEERING SAMPLES PROVIDE ANY PARTICULAR FUNCTIONALITY, OR THAT ITS ENGINEERING SAMPLES WILL MEET THE REQUIREMENTS OF A PARTICULAR USER APPLICATION. APEI DOES NOT WARRANT THAT ITS ENGINEERING SAMPLES ARE ERROR-FREE, NOR DOES APEI MAKE ANY OTHER REPRESENTATIONS OR WARRANTIES, WHETHER EXPRESS OR IMPLIED, STATUTORY OR OTHERWISE, INCLUDING WITHOUT LIMITATION, IMPLIED WARRANTIES OF MERCHANTABILITY, FITNESS FOR A PARTICULAR PURPOSE, OR NON-INFRINGEMENT.**

**APEI'S PRODUCTS AND PROTOTYPES ARE ENGINEERING SAMPLES AND ARE NOT DESIGNED OR INTENDED TO BE FAIL-SAFE, FAULT TOLERANT OR FOR USE IN ANY APPLICATION THAT COULD LEAD TO DEATH, PERSONAL INJURY OR SEVERE PROPERTY OR ENVIRONMENTAL DAMAGE (INDIVIDUALLY AND COLLECTIVELY, "CRITICAL APPLICATIONS"), SUCH AS LIFE-SUPPORT OR SAFETY DEVICES OR SYSTEMS, CLASS III MEDICAL DEVICES, NUCLEAR FACILITIES, APPLICATIONS THAT AFFECT CONTROL OF A VEHICLE OR AIRCRAFT, APPLICATIONS RELATED TO THE DEPLOYMENT OF AIRBAGS, OR ANY OTHER CRITICAL APPLICATIONS. APEI SHALL NOT BE LIABLE FOR ANY DAMAGES, INCLUDING WITHOUT LIMITATION DIRECT, INDIRECT, INCIDENTAL, SPECIAL, RELIANCE, PUNITIVE OR CONSEQUENTIAL DAMAGES IN ANY MANNER WHATSOEVER, ARISING FROM OR IN CONNECTION WITH THE USE OF ITS PRODUCTS, SAMPLES OR PROTOTYPES IN CRITICAL APPLICATIONS, EVEN IF APEI HAS BEEN ADVISED OF THE POSSIBILITY THEREOF.**

No license, express or implied, by estoppel or otherwise, to any intellectual property rights is granted by this document or by any conduct of APEI.

**ORDERING INSTRUCTIONS**

An order for one or more parts can be initiated by issuing a purchase order to APEI, Inc. Please e-mail or fax your purchase order to [sales@apei.net](mailto:sales@apei.net) or +1.866.515.6604, respectively.

APEI, Inc.  
535 W. Research Center Blvd.  
Fayetteville, AR 72701  
Phone: 479.443.5759 / Fax: 866.515.6604  
[www.apei.net](http://www.apei.net)  
Copyright © 2013 APEI, Inc.  
All rights reserved.

