

DATA SHEET



TEA6823T; TEA6825T In Car Entertainment (ICE) car radio

Preliminary specification
File under Integrated Circuits, IC01

1998 Mar 24

In Car Entertainment (ICE) car radio**TEA6823T; TEA6825T****FEATURES****General**

- FM mixer for conversion from FM-IF₁ = 72.2 MHz to FM-IF₂ = 10.7 MHz
- AM mixer for conversion from AM-IF₁ = 10.7 MHz to AM-IF₂ = 450 kHz
- FM-IF gain stage
- Crystal oscillator providing mixer frequencies and references for IF-count and stereo decoder
- FM quadrature demodulator with automatic centre frequency adjustment and THD compensation
- Level, multi-path and noise detectors
- Soft mute
- Stereo noise cancelling and variable de-emphasis
- PLL stereo decoder
- Noise blanker
- AM IF-amplifier and demodulator
- I²C-bus transceiver with interface to enable direct data transfer to radio front-end
- IF-count for AM and FM
- Reference frequency generation for PLL synthesizer.

**Stereo decoder**

- Adjustment-free PLL VCO
- Pilot depending mono/stereo switching
- Analog control of mono/stereo blend
- Adjacent channel noise suppression (114 kHz)
- Pilot cancelled
- Analog control of de-emphasis
- Integrated low-pass filters for 190 kHz adjacent channel interferences and signal delay for interference absorption circuit.

GENERAL DESCRIPTION

The TEA6823T together with the TEA6811T and the TEA6825T together with the TEA6810T form an AM/FM electronic tuned car radio in a double conversion receiver concept.

ORDERING INFORMATION

TYPE NUMBER	PACKAGE		
	NAME	DESCRIPTION	VERSION
TEA6823T	VSO56	plastic very small outline package; 56 leads	SOT190-1
TEA6825T	VSO56	plastic very small outline package; 56 leads; face down	SOT190-2

In Car Entertainment (ICE) car radio

TEA6823T; TEA6825T

QUICK REFERENCE DATA

SYMBOL	PARAMETER	CONDITIONS	MIN.	TYP.	MAX.	UNIT
V _{DDA1}	analog supply voltage 1 (+5 V; pin 5)	note 1	4.5	5.0	5.5	V
		operating range	4.75	5.0	5.25	V
I _{DDA1}	analog supply current 1 (pin 5)	FM mode	17	21	25	mA
		AM mode	14	17	21	mA
I ₁₉ + I ₂₀	total FM mixer output current		4.8	6.0	7.2	mA
I ₂₂ + I ₂₃	total AM mixer output current		10	12	14	mA
V _{DDA2}	analog supply voltage 2 (pin 28)	note 1	7.0	8.5	10	V
		operating range	8.1	8.5	8.9	V
I _{DDA2}	analog supply current 2 (pin 28)	FM mode	2.4	3.0	3.6	mA
V _{DDA3}	analog supply voltage 3 (+8.5 V; pin 56)	note 1	7.0	8.5	10	V
		operating range	8.1	8.5	8.9	V
I _{DDA3}	analog supply current 3 (pin 56)	FM mode	19	24	28	mA
		AM mode	9.5	12	15	mA
V _{DDD}	digital supply voltage 1 (+5 V; pin 52)	note 1	4.5	5.0	5.5	V
		operating range	4.75	5.0	5.25	V
I _{DDD}	digital supply current (pin 52)	note 1	8	10	12	mA
$\frac{S + N}{N}$	signal plus noise-to-noise ratio	FM mode; $\Delta f = 22.5$ kHz at pins 43 and 47	66	75	–	dB
		AM mode; m = 0.3	54	60	–	dB
THD	total harmonic distortion	FM mode; $\Delta f = 75$ kHz	–	0.1	0.35	%
		AM mode	–	1.5	3	%
α_{cs}	channel separation (adjusted)		40	–	–	dB
T _{amb}	operating ambient temperature		–40	–	+85	°C

Note

1. IC is operating; specified parameters may deviate from limits which are valid for operating range.

In Car Entertainment (ICE) car radio

TEA6823T; TEA6825T

BLOCK DIAGRAM

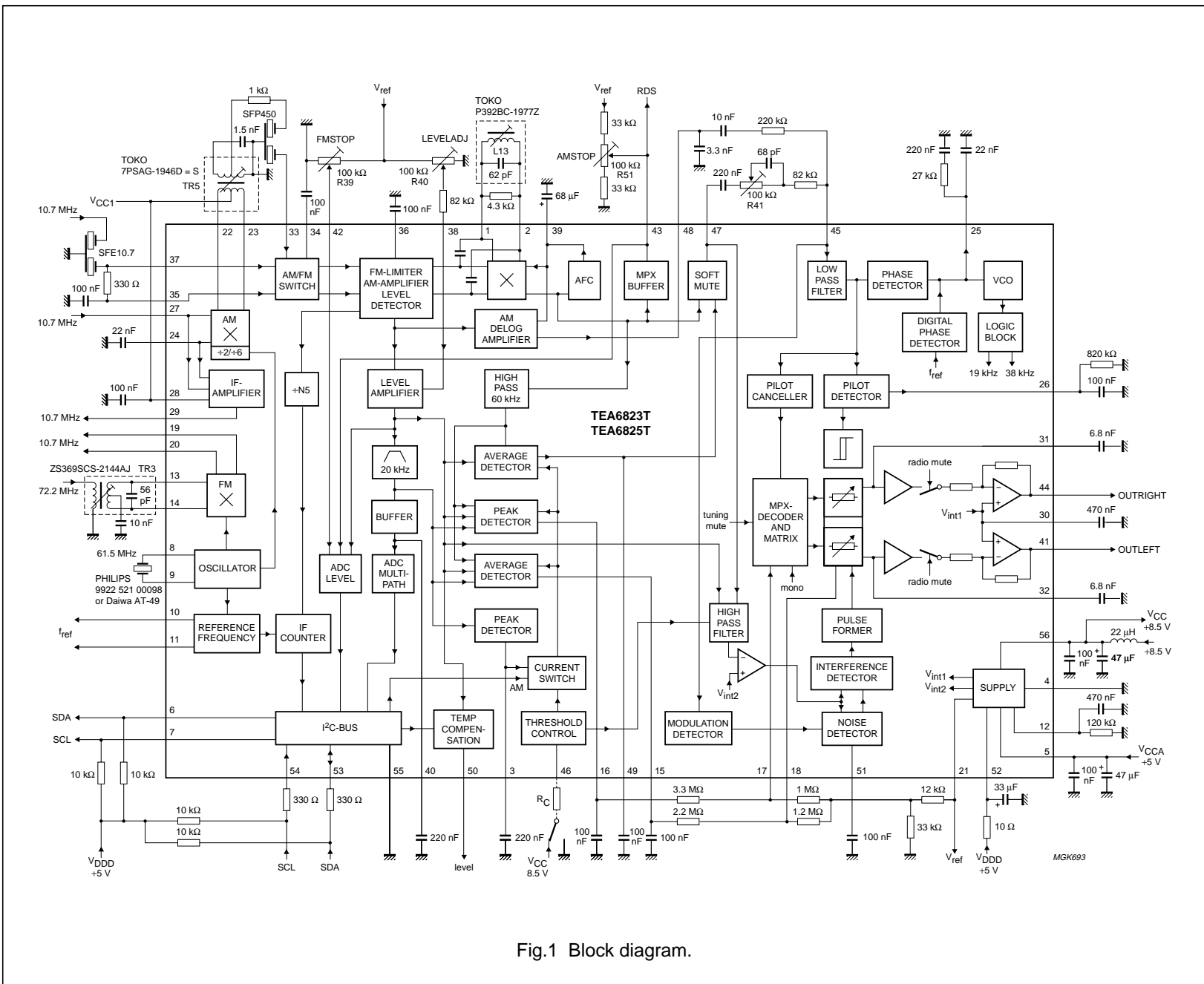

Fig.1 Block diagram.

In Car Entertainment (ICE) car radio

TEA6823T; TEA6825T

PINNING

SYMBOL	PIN	DESCRIPTION
QDET1	1	demodulator tank 1
QDET2	2	demodulator tank 2
TSWITCH	3	time switch input
AGND	4	analog ground
V _{DDA1}	5	analog supply voltage 1 (+5 V)
HFBUS1	6	HF bus 1 output; pull-up to +5 V
HFBUS2	7	HF bus 2 output; pull-up to +5 V
XTAL1	8	crystal oscillator 1
XTAL2	9	crystal oscillator 2
f _{ref(p)}	10	PLL reference frequency output (p)
f _{ref(n)}	11	PLL reference frequency output (n)
I _{ref}	12	reference current
FMIF1IN1	13	72 MHz FM-IF input 1
FMIF1IN2	14	72 MHz FM-IF input 2
TSDR	15	time constant for SDR
TSDS	16	time constant for SDS
V _{SDS}	17	SDS control voltage input
V _{SDR}	18	SDR control voltage input
FMIF2OUT1	19	FM mixer output 1
FMIF2OUT2	20	FM mixer output 2
V _{ref}	21	reference voltage output
AMIF2OUT1	22	AM mixer output 1
AMIF2OUT2	23	AM mixer output 2
FMAMDEC	24	FM/AM 10.7 MHz decoupling
PHASEDET	25	phase detector output
PILDET	26	pilot detector output
FMAM10.7	27	FM/AM 10.7 MHz input
V _{DDA2}	28	analog supply voltage 2

SYMBOL	PIN	DESCRIPTION
FMIFAMP OUT	29	FM-IF amplifier output
AFGND	30	AF ground
DEEMPHR	31	de-emphasis capacitor right
DEEMPHL	32	de-emphasis capacitor left
AMIF2IN1	33	AM-IF ₂ input 1
AMIF2IN2	34	AM-IF ₂ input 2
FMIN2	35	FM limiter input
DCFEED	36	DC feed FM limiter
FMIN1	37	FM limiter input
LEVELADJ	38	level adjustment input
C _{AFC}	39	AFC capacitor
MPBUF	40	multi-path buffer time constant
OUTLEFT	41	AF output left
FMSTOP	42	FMSTOP adjustment input
RDS/AMSTOP	43	MPX for RDS/AMSTOP adjustment input
OUTRIGHT	44	AF output right
MPXIN	45	stereo decoder MPX input
THRES	46	threshold
MPXOUT	47	FM demodulator MPX output
AMAFOUT	48	AM demodulator AF output
V _{mute/AML}	49	mute voltage/AM level
LEVELUNWEIG	50	unweighted level output
IAC _{CONTR}	51	IAC control voltage
V _{DDD}	52	digital supply voltage
SDA	53	serial data input/output; pull-up to +5 V
SCL	54	serial clock input; pull-up to +5 V
DGND	55	digital ground
V _{DDA3}	56	analog supply voltage 3 (+8.5 V)

In Car Entertainment (ICE) car radio

TEA6823T; TEA6825T

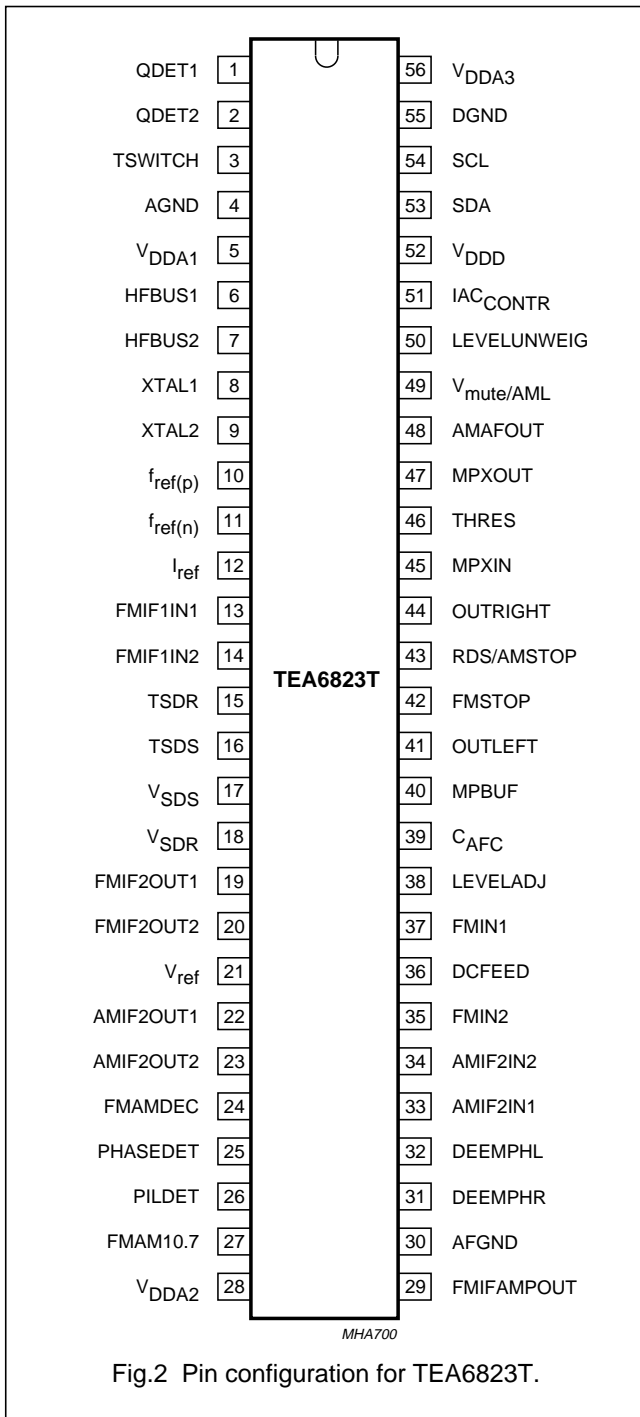

Fig.2 Pin configuration for TEA6823T.

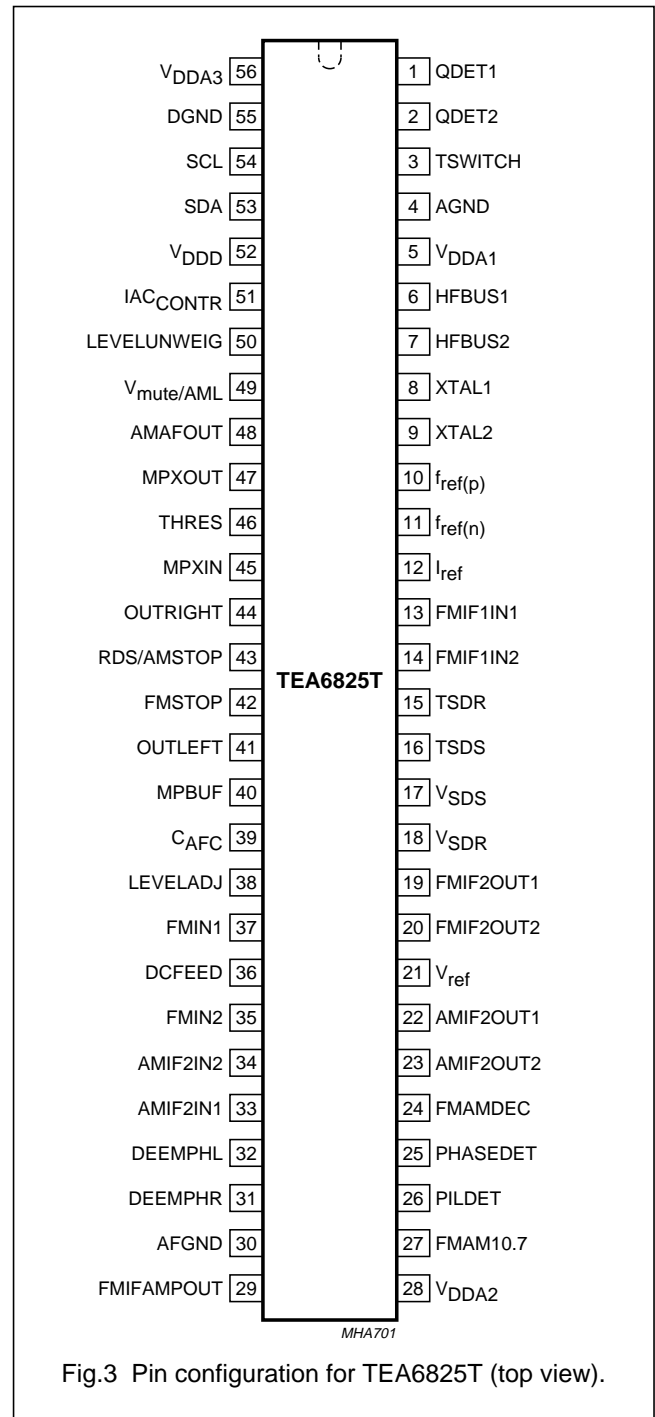

Fig.3 Pin configuration for TEA6825T (top view).

FUNCTIONAL DESCRIPTION

Stereo decoder

By changing the value of the input resistor at pin 12 the MPX input can be adapted to the level of the FM demodulator output (see Fig.16).

A 3rd order low-pass filter ($f_g = 90$ kHz) at the MPX input provides an extra 190 kHz ACI suppression.

An interference gate is connected at the MPX demodulator outputs. For AM the VCO is switched off.

In Car Entertainment (ICE) car radio

TEA6823T; TEA6825T

LIMITING VALUES

In accordance with the Absolute Maximum Rating System (IEC 134).

SYMBOL	PARAMETER	CONDITIONS	MIN.	MAX.	UNIT
V _{DDA1}	analog supply voltage 1 (pin 5)		-0.3	+6.5	V
V _{DDA2}	analog supply voltage 2 (pin 28)		-0.3	+12	V
V _{DDA3}	analog supply voltage 3 (pin 56)		-0.3	+12	V
V _{DDD}	digital supply voltage (pin 52)		-0.3	+6.5	V
T _{stg}	storage temperature		-55	+150	°C
T _{amb}	operating ambient temperature		-40	+85	°C
V _{es}	electrostatic handling	note 1			
	pins 8 and 9		-100	+100	V
	all other pins		-300	+300	V

Note

- Charge device model class B: equivalent to discharging a 200 pF capacitor via a 0 Ω series resistor.

CHARACTERISTICS

V₅₆₋₄ = V₂₈₋₄ = 8.5 V; V₅₋₄ = V₅₂₋₅₅ = 5 V; T_{amb} = 25 °C; f_{mod} = 1 kHz; deviation = 22.5 kHz; R_g = 50 Ω; V₃₇₋₃₅ = 10 mV; with de-emphasis = 50 μs; coil quality = 15; unless otherwise specified.

SYMBOL	PARAMETER	CONDITIONS	MIN.	TYP.	MAX.	UNIT
Currents						
I _{DDA1}	analog supply current 1 (pin 5)	FM mode	17	21	25	mA
		AM mode	14	17	21	mA
I _{DDA2}	analog supply current 2 (pin 28)	FM mode	2.4	3.0	3.6	mA
I _{DDA3}	analog supply current 3 (pin 56)	FM mode	19	24	28	mA
		AM mode	9.5	12	15	mA
I _{DDD}	digital supply current (pin 52)		8	10	12	mA
I ₁₉ + I ₂₀	total FM mixer output current		4.8	6.0	7.2	mA
I ₂₂ + I ₂₃	total AM mixer output current	AM mode	10	12	14	mA
FM-IF path; see Fig.4						
V _{19-20 max(p-p)}	maximum output voltage (peak-to-peak value)		12.0	14.0	–	V
I ₁₉ ; I ₂₀	mixer bias current		2.4	3.0	3.6	mA
	mixer leakage current	in AM position	–	–	2	μA
I _{19IF2} /V _{13-14IF1}	conversion gain		1.65	1.9	2.2	mS
R _i	input resistance (pins 13 to 14)		5	7	–	kΩ
C _i	input capacitance (pins 13 to 14)		–	3	4.5	pF
R _{opt}	optimum generator resistance		–	1.2	–	kΩ
R _o	output resistance (pins 19 to 20)		15	20	–	kΩ
C _o	output capacitance (pins 19 to 4 and pins 20 to 4)		–	12	14	pF
IP3	third order intermodulation		114	124	–	dBμV

In Car Entertainment (ICE) car radio

TEA6823T; TEA6825T

SYMBOL	PARAMETER	CONDITIONS	MIN.	TYP.	MAX.	UNIT
Oscillator						
f_{osc}	oscillator frequency		–	61.5	–	MHz
Δf_{osc}	oscillator frequency spread		–	–	250	Hz
$\Delta f_{osc}/\Delta T$	temperature dependence of oscillator frequency	crystal type Philips 9922 521 00098	–	30×10^{-6}	–	K ⁻¹
R_1	crystal motional resistance		–	–	70	Ω
C_0	crystal shunt capacitance		–	–	5	pF
FM-IF₂ amplifier						
$V_{27-24 \max(rms)}$	maximum input voltage for 1 dB compression point (RMS value)		80	110	–	mV
$V_{29-4 \max(rms)}$	maximum output voltage (RMS value)		220	320	–	mV
V_{29-4}/V_{27-24}	amplifier gain	$R_L = 330 \Omega$; see Fig.5	9	12	15	dB
$\Delta V_{29-4}/V_{27-24}$	gain temperature dependence	$-25 \text{ }^\circ\text{C} < T_{amb} < +85 \text{ }^\circ\text{C}$	–	0.1	–	dB/K
R_i	input resistance (pins 27 to 24)		300	330	360	Ω
C_i	input capacitance (pins 27 to 4)		–	–	5	pF
R_o	output resistance (pin 29)		300	330	360	Ω
C_o	output capacitance (pins 29 to 4)		–	–	5	pF
FM-IF₂ limiter						
$V_{o \ 1-2(p-p)}$	limiter output voltage (peak-to-peak value)		500	700	–	mV
V_{1-2}/V_{37-35}	limiter gain	see Fig.6	–	80	–	dB
C_i	input capacitance (pins 37 to 4)		–	–	5	pF
R_o	output resistance (pins 1 to 2)		–	–	1.0	k Ω
C_o	output capacitance (pins 1 to 2)		10	15	20	pF

In Car Entertainment (ICE) car radio

TEA6823T; TEA6825T

SYMBOL	PARAMETER	CONDITIONS	MIN.	TYP.	MAX.	UNIT
FM demodulator						
$V_{47-4(rms)}$	MPX output voltage (RMS value)		160	200	240	mV
$V_{43-4(rms)}$	MPX output voltage for RDS (RMS value)		160	200	240	mV
$V_{37-35(rms)}$	start of limiting voltage (RMS value)	$\alpha_{AF} = -3$ dB	–	25	40	μ V
$V_{37-35(rms)}$	input voltage for signal plus noise-to-noise ratio (RMS value)	see Fig.7 for pin 47 (MPXOUT) and Fig.8 for pin 43 (RDS/AMSTOP) $\frac{S+N}{N} = 26$ dB $\frac{S+N}{N} = 46$ dB	–	30	45	μ V
ΔV_{43DC}	residual DC-offset voltage	$\Delta L_{demod} = \text{typical value}$	–	100	1000	mV
		$10 \mu\text{V} < V_{37-35} < 80 \mu\text{V}$ $80 \mu\text{V} < V_{37-35} < 800 \text{mV}$	–	10	30	mV
V_{43FM}/V_{43AM}	AM suppression	$\Delta f = 22.5$ kHz; $f_{modAM} = 1$ kHz; $m_{AM} = 30\%$; $V_{37-35} = 3$ to 300 mV	50	60	–	dB
V_{47FM}/V_{47AM}	AM suppression	$V_{37-35} = 1$ to 300 mV	50	60	–	dB
$\Delta V_{43-44AFCdis} / \Delta V_{43-44AFCactive}$	demodulator frequency control voltage (AFC) efficiency	at 100 kHz detune from exact tuning	28	32	–	dB
R_o	output resistance (pin 47)		–	–	3	k Ω
	output resistance (pin 43)		–	–	1.5	k Ω
	AF bandwidth (pin 43)		200	–	–	kHz
$\frac{S+N}{N}$	signal plus noise-to-noise ratio		66	75	–	dB
THD	total harmonic distortion	detuning ≤ 50 kHz; $\Delta f = 75$ kHz; $f_{mod} = 1$ kHz without de-emphasis; $L_{demod} = \text{typical value}$ pin 43; $V_{37-35} = 300 \mu\text{V}$ to 800 mV	–	0.1	0.35	%
		pin 47; $V_{37-35} = 1$ to 800 mV	–	0.1	0.35	%

In Car Entertainment (ICE) car radio

TEA6823T; TEA6825T

SYMBOL	PARAMETER	CONDITIONS	MIN.	TYP.	MAX.	UNIT
Unweighted voltage level						
V_{50-4}	unweighted voltage level	see Fig.9; $V_{38} = 2.52 \text{ V}$ $V_{37-35} \leq 2.5 \mu\text{V}$ $V_{37-35} = 1.0 \text{ mV}$	1.6 2.7	2.2 3.4	3.0 4.7	V V
$\Delta V_{50-4}/\Delta V_{37-35}$	slope of unweighted voltage level	$100 \mu\text{V (RMS)} \leq V_{37-35} < 300 \text{ mV}$ temperature compensation off temperature compensation on	0.75 0.6	0.9 0.75	1.05 0.9	V/20 dB V/20 dB
$\Delta V_{50-4}/\text{VK}$	temperature dependence	$V_{37-35} = 1 \text{ mV}$ temperature compensation off temperature compensation on	– –	5.0 2.0	– –	mV/VK mV/VK
$I_{50(\text{max})\text{source}}$	maximum output source current		0.3	–	–	mA
$I_{50(\text{max})\text{sink}}$	maximum output sink current		–50	–	–	μA
R_{o50}	output resistance		–	–	300	Ω
ADJUSTMENT OF UNWEIGHTED VOLTAGE LEVEL AND $V_{\text{mute/AML}}$; note 1						
ΔV_{50}	adjusting range voltage	$V_{37-35} = 10 \text{ mV (RMS)}$	–1.8	–	+1.8	V
V_{38-4}	internal bias voltage		–	2.6	–	V
$\Delta V_{50-4}/\Delta V_{38-4}$	adjusting gain		–	–0.9	–	–
R_{i38}	input resistance		–	80	–	k Ω
MUTING DEPENDENCE ON ADJUST OF LEVEL UNWEIGHTED VOLTAGE; note 2						
V_{43}/V_{47}	start of mute	$V_{49}/V_{21} = 0.625$	1	3	7	dB
$\frac{\Delta V_{43}/V_{47}}{\Delta V_{49}}$	mute slope	$V_{43}/V_{47} = -6 \text{ dB}$	–	25	–	dB/V
Soft mute, time constant control, mono/stereo blend and high-cut control; see Fig.22						
MUTE VOLTAGE; note 3						
V_{49-4}	mute voltage	$V_{38} = 2.52 \text{ V}$ $V_{37-35} < 2.5 \mu\text{V}$ $V_{37-35} = 1.0 \text{ mV}$	1.8 2.7	2.2 3.4	3.2 4.7	V V
$\Delta V_{49-4}/\Delta V_{37-35}$	slope of mute voltage	$100 \mu\text{V (RMS)} \leq V_{37-35} < 300 \text{ mV}$	0.75	0.9	1.05	V/20 dB
$\Delta V_{49-4}/\text{VK}$	temperature dependency	$V_{37-35} = 1 \text{ mV}$	–	5.0	–	mV/VK

In Car Entertainment (ICE) car radio

TEA6823T; TEA6825T

SYMBOL	PARAMETER	CONDITIONS	MIN.	TYP.	MAX.	UNIT
ATTACK AND DECAY TIME FOR MUTE VOLTAGE						
I_{ch}	charge current	pin 3 connected to GND	–	3.5	–	μA
		pin 3 connected to pin 5	–	150	–	μA
I_{dch}	discharge current	pin 3 connected to GND	–	–4.0	–	μA
		pin 3 connected to pin 5	–	–170	–	μA
Δf	muting activated by 60 kHz FM interference	$V_{49} < 3 \text{ V}$; $V_{37-35} = 3 \text{ mV}$; $f_{mod} = 60 \text{ kHz}$ pin 3 connected to GND; $V_{43}/V_{47} = 9 \text{ dB}$	–	40	–	kHz
		pin 3 connected to pin 5; $V_{43}/V_{47} = 6 \text{ dB}$	–	40	–	kHz
V_{43}/V_{47}	maximum mute depth by 60 kHz FM interference	pin 3 connected to GND	–	15	–	dB
		pin 3 connected to pin 5	–	10	–	dB
TIME CONSTANT FOR MONO/STEREO BLEND VOLTAGE; note 4						
I_{ch}	charge current	$V_{37-35} = 3 \text{ mV}$; pin 3 connected to GND	–	0.6	–	μA
		$V_{37-35} = 3 \text{ mV}$; pin 3 connected to pin 5	–	23	–	μA
I_{dch}	discharge current	$V_{37-35} = 3 \text{ mV}$; pin 3 connected to GND	–	–17	–	μA
		$V_{37-35} = 3 \text{ mV}$; pin 3 connected to pin 5	–	–750	–	μA
m	mono/stereo blend activated by 20 kHz AM interference	$V_{16} < 2 \text{ V}$; $V_{37-35} = 3 \text{ mV}$; $R_{L16} > 50 \text{ M}\Omega$; $f_{mod} = 20 \text{ kHz}$; data byte 2 bit 5 = 0				
		pin 3 connected to GND	–	45	–	%
		pin 3 connected to pin 5	–	45	–	%
		data byte 2 bit 5 = 1				
Δf	mono/stereo blend activated by 60 kHz FM interference	pin 3 connected to GND	–	55	–	%
		pin 3 connected to pin 5	–	55	–	%
Δf	mono/stereo blend activated by 60 kHz FM interference	$V_{16} < 2 \text{ V}$; $V_{37-35} = 3 \text{ mV}$; $R_{L16} > 50 \text{ M}\Omega$; $f_{mod} = 60 \text{ kHz}$ pin 3 connected to GND	–	50	–	kHz
		pin 3 connected to pin 5	–	50	–	kHz

In Car Entertainment (ICE) car radio

TEA6823T; TEA6825T

SYMBOL	PARAMETER	CONDITIONS	MIN.	TYP.	MAX.	UNIT
TIME CONSTANT FOR HIGH-CUT CONTROL VOLTAGE SDR; note 5						
I_{ch}	charge current	$V_{37-35} = 3 \text{ mV}$; pin 3 connected to GND	–	0.6	–	μA
		$V_{37-35} = 3 \text{ mV}$; pin 3 connected to pin 5	–	41	–	μA
I_{dch}	discharge current	$V_{37-35} = 3 \text{ mV}$; pin 3 connected to GND	–	–0.7	–	μA
		$V_{37-35} = 3 \text{ mV}$; pin 3 connected to pin 5	–	–44	–	μA
m	high-cut control activated by 20 kHz AM interference	$V_{15} < 2 \text{ V}$; $V_{37-35} = 3 \text{ mV}$; $R_{L15} > 50 \text{ M}\Omega$; $f_{mod} = 20 \text{ kHz}$ pin 3 connected to GND	–	45	–	%
		pin 3 connected to pin 5	–	45	–	%
Δf	high-cut control activated by 60 kHz FM interference	$V_{15} < 2 \text{ V}$; $V_{37-35} = 3 \text{ mV}$; $R_{L15} > 50 \text{ M}\Omega$; $f_{mod} = 60 \text{ kHz}$ pin 3 connected to GND	–	50	–	kHz
		pin 3 connected to pin 5	–	50	–	kHz
MULTI-PATH DETECTOR						
f_{MP}	multi-path detector band-pass centre frequency		–	20	–	kHz
B_{MP}	band-pass bandwidth		7.0	–	–	kHz
Reference voltage						
V_{21-4}	output voltage	$I_{21} = -1 \text{ mA}$	4.5	5.1	5.7	V
ΔV_{21-4}	temperature dependence		–	3.3	–	mV/VK
I_{21}	output current		–	–	1	mA
AM-IF path; see Fig.14 and notes 6 and 7						
$V_{22-23 \text{ max(p-p)}}$	maximum output voltage (peak-to-peak value)		12	15	–	V
I_{22}, I_{23}	mixer bias current		5.0	6.0	7.0	mA
	mixer leakage current	in FM position	–	–	2	μA
$I_{22}I_{F2}/V_{27-24}I_{F1}$	conversion transconductance		2.2	2.7	3.4	mS
R_{27-24}	input resistance		300	330	360	Ω
C_{27-24}	input capacitance		–	5	8	pF
R_{22-23}	output resistance		10.0	20.0	–	k Ω
C_{22-23}	output capacitance		–	5	10	pF
IP3	third order intermodulation		–	137	–	dB μV

In Car Entertainment (ICE) car radio

TEA6823T; TEA6825T

SYMBOL	PARAMETER	CONDITIONS	MIN.	TYP.	MAX.	UNIT
AM DETECTOR; notes 8 and 9						
$V_{48-4(rms)}$	AF output level (RMS value)	$R_{L48} > 500 \text{ k}\Omega$; $100 \mu\text{V} \leq V_{33-34} \leq 300 \text{ mV}$	190	240	290	mV
$V_{33-34(rms)}$	sensitivity voltage (RMS value)	$\frac{S+N}{N} = 26 \text{ dB}$	–	50	75	μV
		$\frac{S+N}{N} = 46 \text{ dB}$	–	200	400	μV
	AM-IF ₂ minimum input voltage (RMS value)	THD $\leq 5\%$; $m = 0.8$	–	–	100	μV
	AM-IF ₂ maximum input voltage (RMS value)	THD $\leq 5\%$; $m = 0.8$	800	–	–	mV
R_{33-34}	IF ₂ input resistance		1.8	2.0	2.2	k Ω
C_{24-23}	IF ₂ input capacitance		–	10	15	pF
R_{048}	output resistance		27	33	39	k Ω
C_{048}	output capacitance		–	–	10	pF
$\frac{S+N}{N}$	signal plus noise-to-noise ratio		54	60	–	dB
THD	total harmonic distortion	$m = 0.8$; $300 \mu\text{V} \leq V_{33-34} \leq 200 \text{ mV}$	–	1.5	3.0	%

Notes to the characteristics

- For typical adjusting range see Figs 10 and 13.
- For typical curve see Fig.11.
- The static mute voltage follows the unweighted voltage level as function of FM-IF₂ voltage and level adjustment voltage V_{38-4} . It additionally depends on multi-path level, noise (adjacent channel interferences) and the position of TSWITCH (pin 3). For typical curve for mute voltage dependence see Fig.12.
- The mono/stereo blend voltage is generated as a function of FM-IF₂ voltage, multi-path level, noise and position of TSWITCH.
- The high-cut control voltage is generated as a function of FM-IF₂ voltage, multi-path level, noise and position of TSWITCH.
- $f_{IF1} = 10.7 \text{ MHz}$; $f_{IF2} = 450 \text{ kHz}$ for AM mixer.
- The AM oscillator signal is generated by division of the 61.5 MHz crystal oscillator. Two divider ratios programmable by the I²C-bus: divide by 6 (AM-IF₁ = 10.7 MHz); divide by 2 (AM-IF₁ = 30 MHz).
- For typical AM level curve see Fig.15.
- For AM detector; $f_{AMIF2} = 450 \text{ kHz}$; $f_{mod} = 400 \text{ Hz}$; $m = 30\%$.

In Car Entertainment (ICE) car radio

TEA6823T; TEA6825T

STEREO DECODER CHARACTERISTICS

Input signal ($\Delta f = 75$ kHz) $V_{MPX(p-p)} = 1.7$ V; $f_{mod} = 1$ kHz; de-emphasis time constant $t = 50$ μ s; nominal input resistor (pin 45) $R_i = 168$ k Ω ; $T_{amb} = 25$ $^{\circ}$ C; unless otherwise specified.

SYMBOL	PARAMETER	CONDITIONS	MIN.	TYP.	MAX.	UNIT
$V_{44-4(rms)}$; $V_{41-4(rms)}$	AF output voltage (RMS value)		800	900	1000	mV
V_{44-4} ; V_{41-4}	DC output voltage		3.1	3.6	4.1	V
$I_{44(max)}$; $I_{41(max)}$	maximum output current		150	–	–	μ A
V_{44-4}/V_{41-4}	difference of output voltage		–1	–	+1	dB
$R_{o(44)}$; $R_{o(41)}$	output resistance		–	–	600	Ω
R_{Lmin}	minimum load resistor		12	–	–	k Ω
α_{cs}	channel separation (adjusted)		40	–	–	dB
$\frac{S+N}{N}$	signal plus noise-to-noise ratio	$f = 20$ Hz to 15 kHz	74	80	–	dB
THD	total harmonic distortion		–	0.1	0.3	%
	MPX input overdrive margin	THD = 1%	4	–	–	dB
Carrier and harmonic suppression at the output; note 1						
α_{19}	pilot signal	$f = 19$ kHz	–	50	–	dB
α_{38}	subcarrier	$f = 38$ kHz	–	50	–	dB
α_{57}		$f = 57$ kHz	–	50	–	dB
α_{76}		$f = 76$ kHz	–	60	–	dB
α_2		intermodulation	$f_{mod} = 10$ kHz; $f_{spur} = 1$ kHz	–	60	–
α_3	$f_{mod} = 13$ kHz; $f_{spur} = 1$ kHz		–	58	–	dB
α_{57}	traffic radio (ARI)	$f = 57$ kHz	–	70	–	dB
α_{67}	subsidiary communications authorization	$f = 67$ kHz	70	–	–	dB
α_{114}	adjacent channel frequency	$f = 114$ kHz	–	80	–	dB
α_{190}		$f = 190$ kHz	–	70	–	dB
RR	ripple rejection at output	$f_r = 100$ Hz; $V_r = 100$ mV (eff.)	–	30	–	dB
Mono/stereo control						
$V_{i(pil)}$	pilot threshold voltage	stereo on	–	24	30	mV
		mono on	8	20	–	mV
$\Delta V_{i(pil)}$	switch hysteresis $V_{i on}/V_{i off}$		–	2	–	dB
External mono/stereo control; note 2						
$V_{17} - 0.75V_{21}$	control voltage channel separation	see Fig.17				
		$V_{43}/V_{47} = 6$ dB	–	–110	–	mV
		$V_{43}/V_{47} = 16$ dB	–	–40	–	mV

In Car Entertainment (ICE) car radio

TEA6823T; TEA6825T

SYMBOL	PARAMETER	CONDITIONS	MIN.	TYP.	MAX.	UNIT
Muting functions (mute via I²C-bus)						
$\Delta V_{44}, \Delta V_{41}$	DC offset voltage	tune mute	-50	-	+50	mV
		radio mute (in combination with tune mute)	-400	-	+400	mV
α_{mute}	tune mute		60	-	-	dB
	radio mute (in combination with tune mute)		80	-	-	dB
High-cut control; see Fig.18						
$V_{18} - 0.75V_{21}$	control voltage	note 3				
		$t_{\text{de-emph}} = 50 \mu\text{s}$	0	-	-	mV
		$t_{\text{de-emph}} = 80 \mu\text{s}$	-300	-	-	mV
$t_{\text{de-emph}}$	control range of de-emphasis		50	-	80	μs
Voltage controlled oscillator; note 4						
f_{osc}	oscillator frequency		225	228	231	kHz
Noise blanker						
INTERFERENCE DETECTION FULLY INTERNAL FROM LEVEL DETECTOR						
t_{sup}	interference suppression time		40	50	-	μs
TRIGGER THRESHOLD CONTROL						
I_{ch}	charge current (into +4 V)		-	45	-	μA
I_{dch}	discharge current (from +8.5 V)		-	-900	-	μA
TRIGGER SENSITIVITY MEASUREMENT WITH PULSED MODULATION OF FM-IF ₂ ; see Figs 19 and 20						
$V_{37-35(p)}$	trigger sensitivity for test signal 1 (peak value)	$V_{38} = 2.52 \text{ V}$; note 5	-	-	0.5	mV
		$V_{38} = 2.52 \text{ V}$; note 6	100	-	-	mV
	trigger sensitivity for test signal 2 (peak value)	$V_{38} = 2.52 \text{ V}$; note 6	5.0	-	-	mV
		$V_{38} = 2.52 \text{ V}$; note 6	100	-	-	mV
V_{51}	trigger threshold variation with frequency modulation of FM-IF ₂ and $f_{\text{mod}} = 15 \text{ kHz}$ (pin 51)	$V_{37-35} = 100 \text{ mV}$; $\Delta f = 0 \text{ kHz}$	-	6.4	-	V
ΔV_{51}		$V_{37-35} = 100 \text{ mV}$; $\Delta f = 40 \text{ kHz}$	-	250	-	mV
$V_{37\text{th}}/V_{37(3\text{dB})}$	shift of threshold for triggering from MPX signal	$I_{46} = 0$	14	20	26	dB
$\Delta V_{37\text{th}}/\Delta I_{46}$	shift of threshold as function of I_{46}		-0.32	-0.25	-0.16	dB/ μA
V_{46}	bias voltage (pin 46)	$I_{46} < 0$	4.0	4.3	4.7	V
		$I_{46} > 0$	5.3	5.7	6.1	V
I_{offset}	gate input offset current at pins 31 and 32 during suppression pulse duration		-	20	50	nA

In Car Entertainment (ICE) car radio

TEA6823T; TEA6825T

Notes to the stereo decoder characteristics

1. The following equations give the values for the carrier and harmonic suppression at the output:

$$\alpha_{27} = \frac{V_0(\text{signal}) (\text{at } 1 \text{ kHz})}{V_0(\text{spurious}) (\text{at } 1 \text{ kHz})} f_s = (2 \times 10 \text{ kHz}) - 19 \text{ kHz}$$

$$\alpha_{33} = \frac{V_0(\text{signal}) (\text{at } 1 \text{ kHz})}{V_0(\text{spurious}) (\text{at } 1 \text{ kHz})} f_s = (3 \times 13 \text{ kHz}) - 38 \text{ kHz}$$

$$\alpha_{57} (\text{ARI}) = \frac{V_0(\text{signal}) (\text{at } 1 \text{ kHz})}{V_0(\text{spurious}) (\text{at } 1 \text{ kHz} \pm 23 \text{ Hz})}$$

$$\alpha_{67} = \frac{V_0(\text{signal}) (\text{at } 1 \text{ kHz})}{V_0(\text{spurious}) (\text{at } 9 \text{ kHz})} f_s = (2 \times 38 \text{ kHz}) - 67 \text{ kHz}$$

$$\alpha_{114} = \frac{V_0(\text{signal}) (\text{at } 1 \text{ kHz})}{V_0(\text{spurious}) (\text{at } 4 \text{ kHz})} f_s = 110 \text{ kHz} - (3 \times 38 \text{ kHz})$$

$$\alpha_{190} = \frac{V_0(\text{signal}) (\text{at } 1 \text{ kHz})}{V_0(\text{spurious}) (\text{at } 4 \text{ kHz})} f_s = 186 \text{ kHz} - (5 \times 38 \text{ kHz})$$

2. The stereo decoder can be set to mono via the I²C-bus. Pilot presence indication via the I²C-bus.
3. The nominal de-emphasis value can be changed to 75 μ s with C₃₁; C₃₂ = 10 nF.
4. The VCO is adjusted by means of a digital auxiliary PLL.
5. Noise blanker does not trigger.
6. Noise blanker triggers.

In Car Entertainment (ICE) car radio

TEA6823T; TEA6825T

CHARACTERISTICS FOR ANALOG-TO-DIGITAL CONVERTERS (ADCs) FOR LEVEL AND MULTI-PATH VOLTAGES

SYMBOL	PARAMETER	CONDITIONS	MIN.	TYP.	MAX.	UNIT
ADC for FM level information; note 1						
ΔV_{37-35}	analog-to-digital conversion					
	step size		2	4	8	dB/step
	level range		43	56	69	dB
FM STOP						
ΔV_{stop}	variation of stop level as function of V_{42-4}		–	16	–	dB/V
ADC for AM level information; note 2						
ΔV_{33-34}	analog-to-digital conversion step size		2	4	8	dB/step
ΔV_{33-34}	analog-to-digital conversion level range		43	56	69	dB
AM STOP						
ΔV_{stop}	variation of stop level as function of V_{43-4}		–	16	–	dB/V
ADC for multi-path information; note 3						
m	multi-path conversion	step 0	–	–	5	%
		step 1	–	15	–	%
		step 2	–	22	–	%
		step 3	–	28	–	%
		step 4	–	34	–	%
		step 5	–	40	–	%
		step 6	–	46	–	%
		step 7	–	52	60	%

Notes

1. The FM level information V_{50-3} is analog-to-digital converted with 4 bits.
2. The AM level information V_{49-4} is analog-to-digital converted with 4 bits.
3. The multi-path information V_{40-4} is analog-to-digital converted with 3 bits covering an IF_2 amplitude modulation range $m \leq 0.6$; $f_{\text{mod}} = 20$ kHz.

In Car Entertainment (ICE) car radio

TEA6823T; TEA6825T

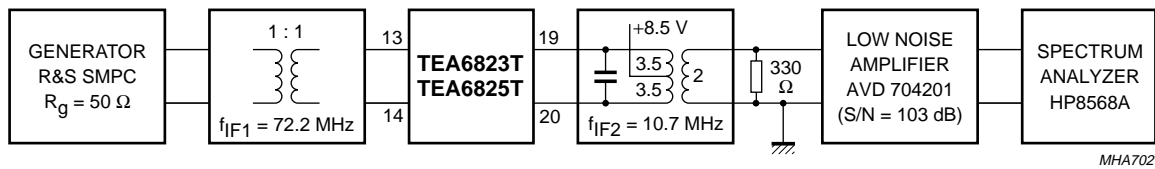

MHA702

Fig.4 Test circuit FM mixer.

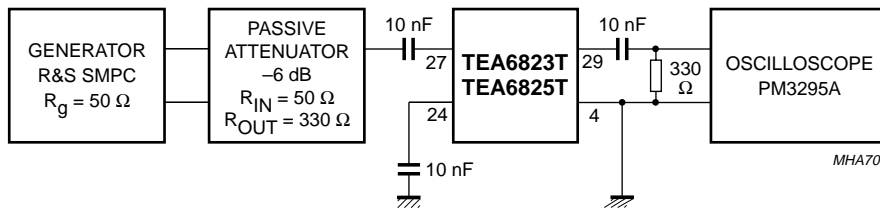

MHA703

Fig.5 Test circuit IF-amplifier.

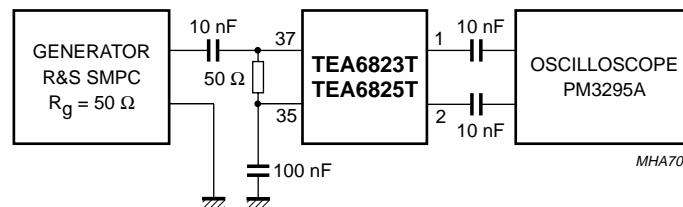

MHA704

Fig.6 Test circuit limiter gain.

In Car Entertainment (ICE) car radio

TEA6823T; TEA6825T

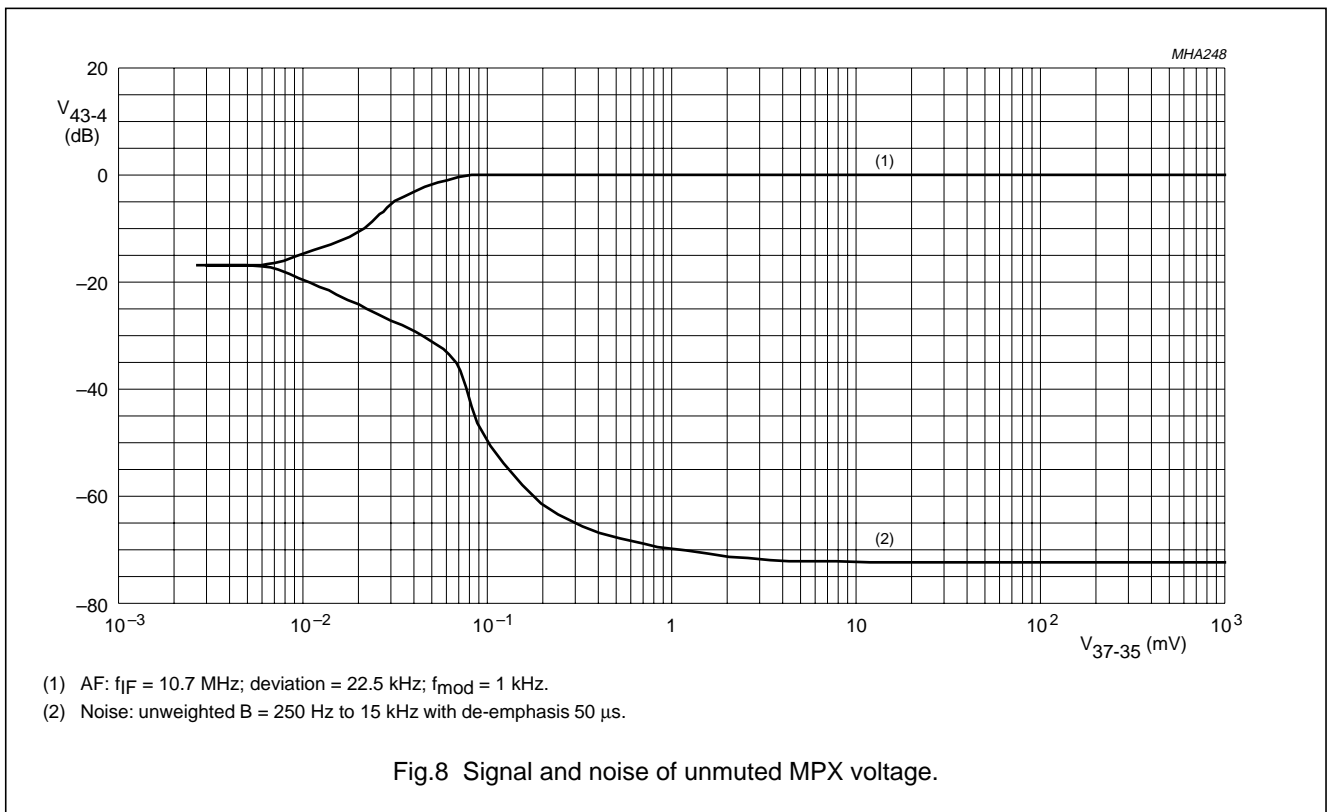
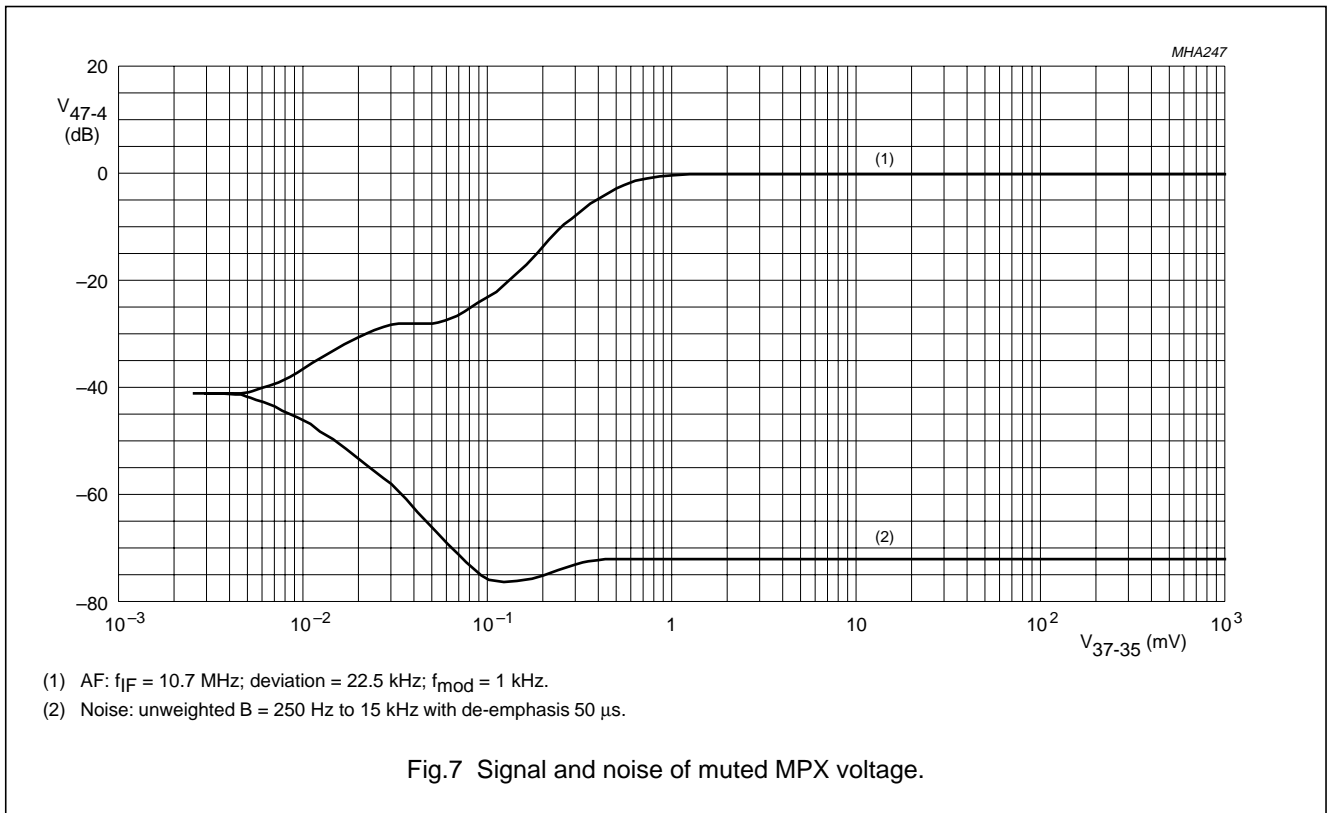

In Car Entertainment (ICE) car radio

TEA6823T; TEA6825T

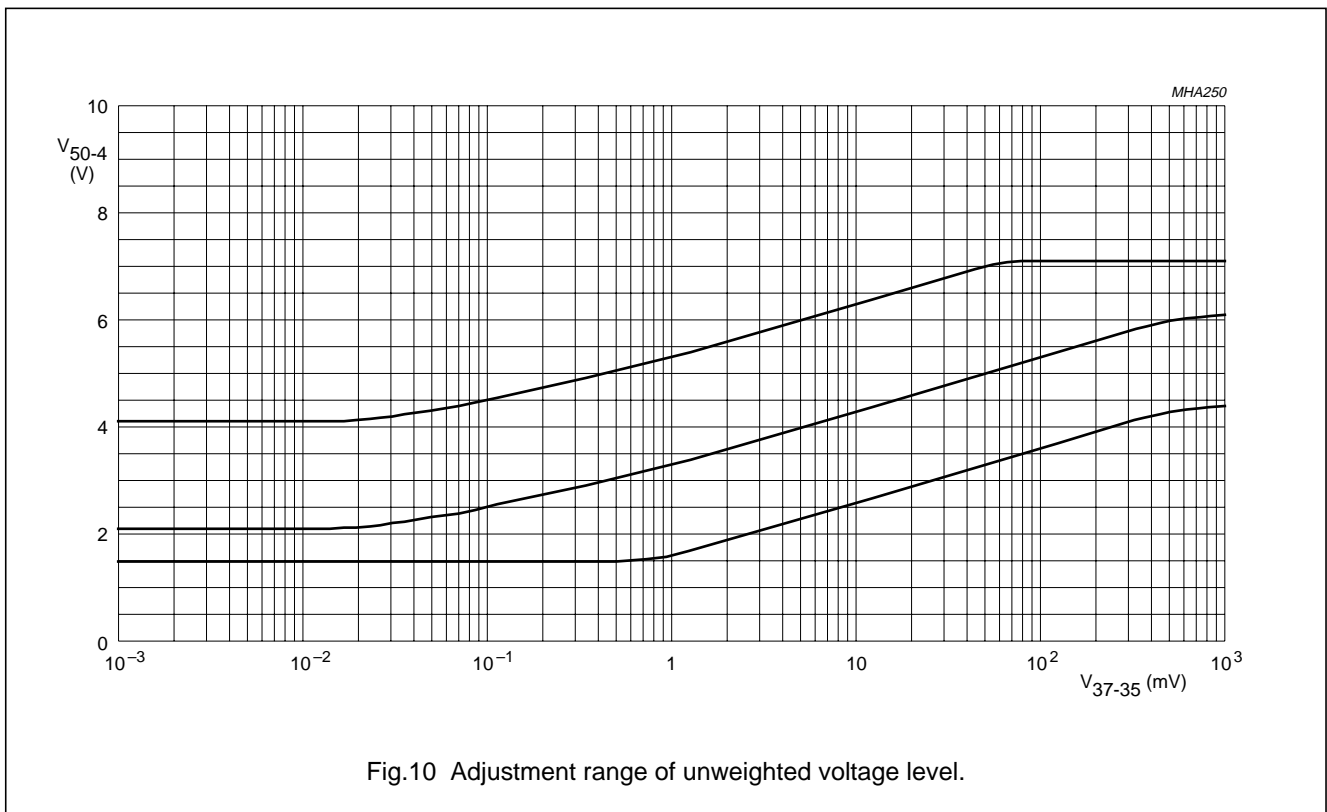
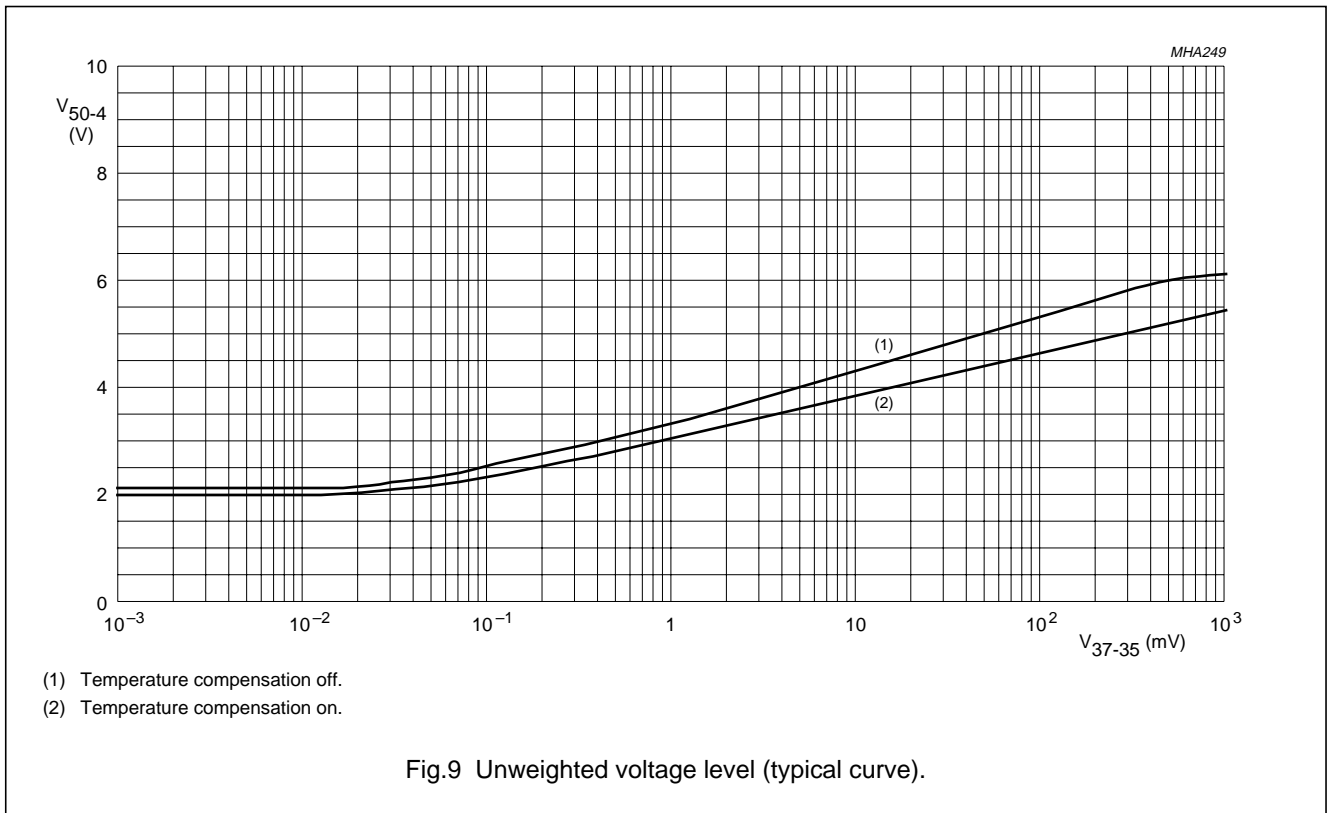

In Car Entertainment (ICE) car radio

TEA6823T; TEA6825T

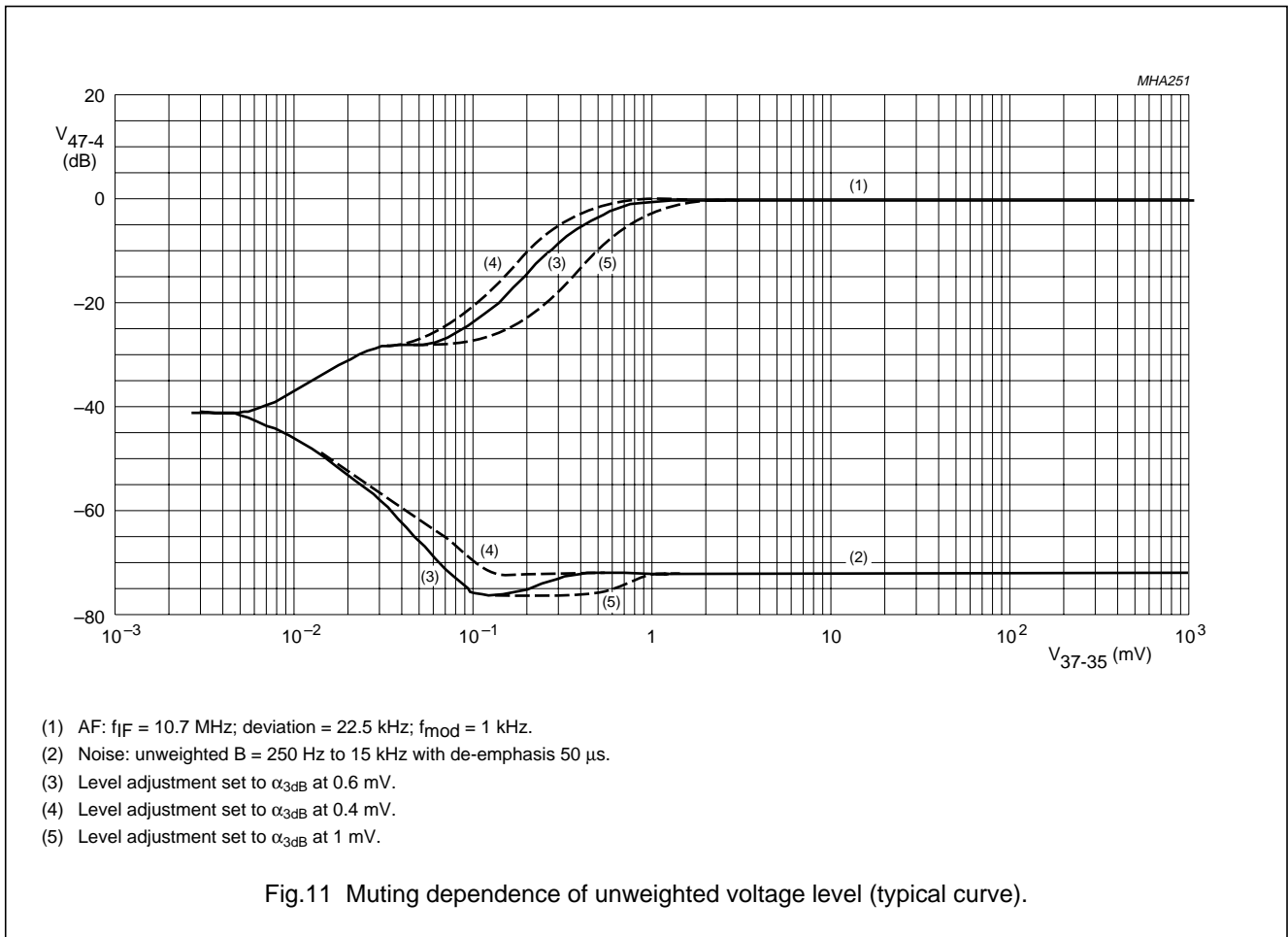

In Car Entertainment (ICE) car radio

TEA6823T; TEA6825T

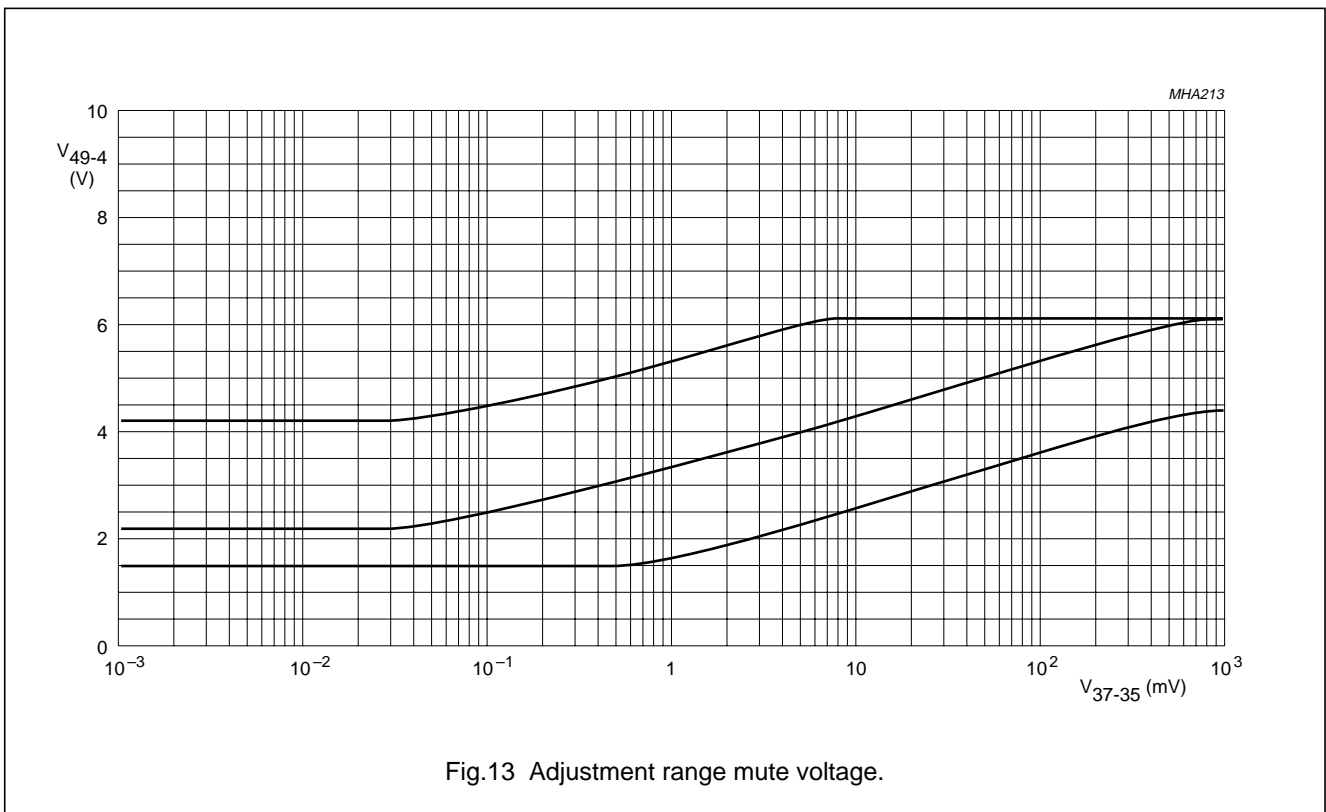
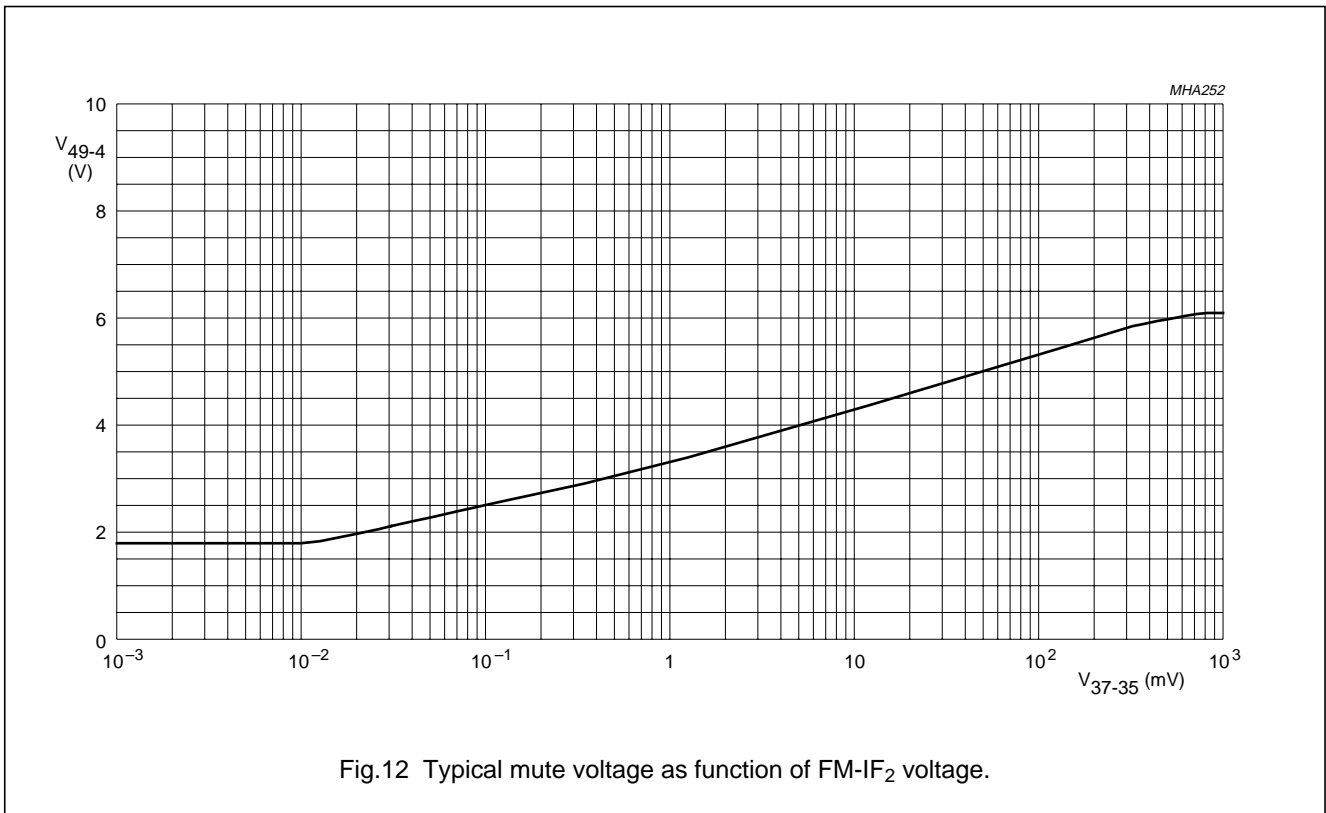

In Car Entertainment (ICE) car radio

TEA6823T; TEA6825T

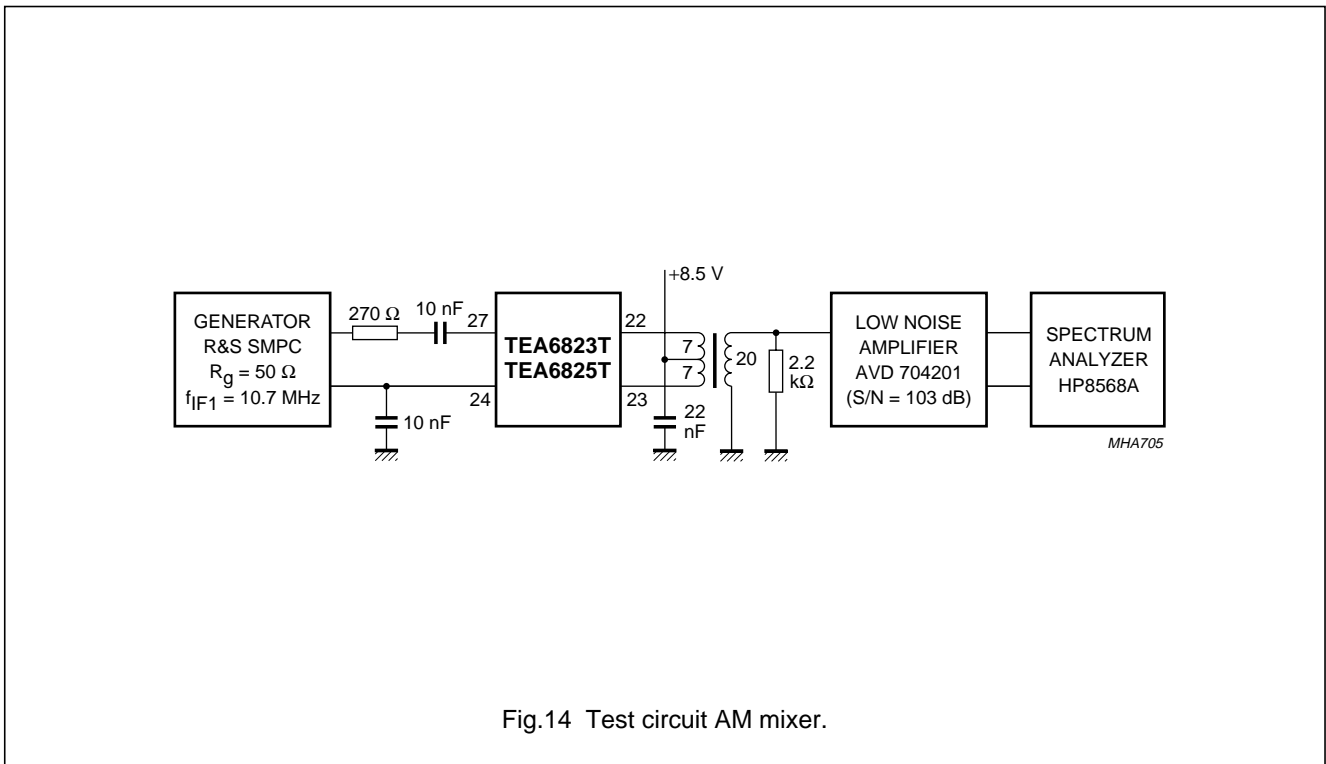

Fig.14 Test circuit AM mixer.

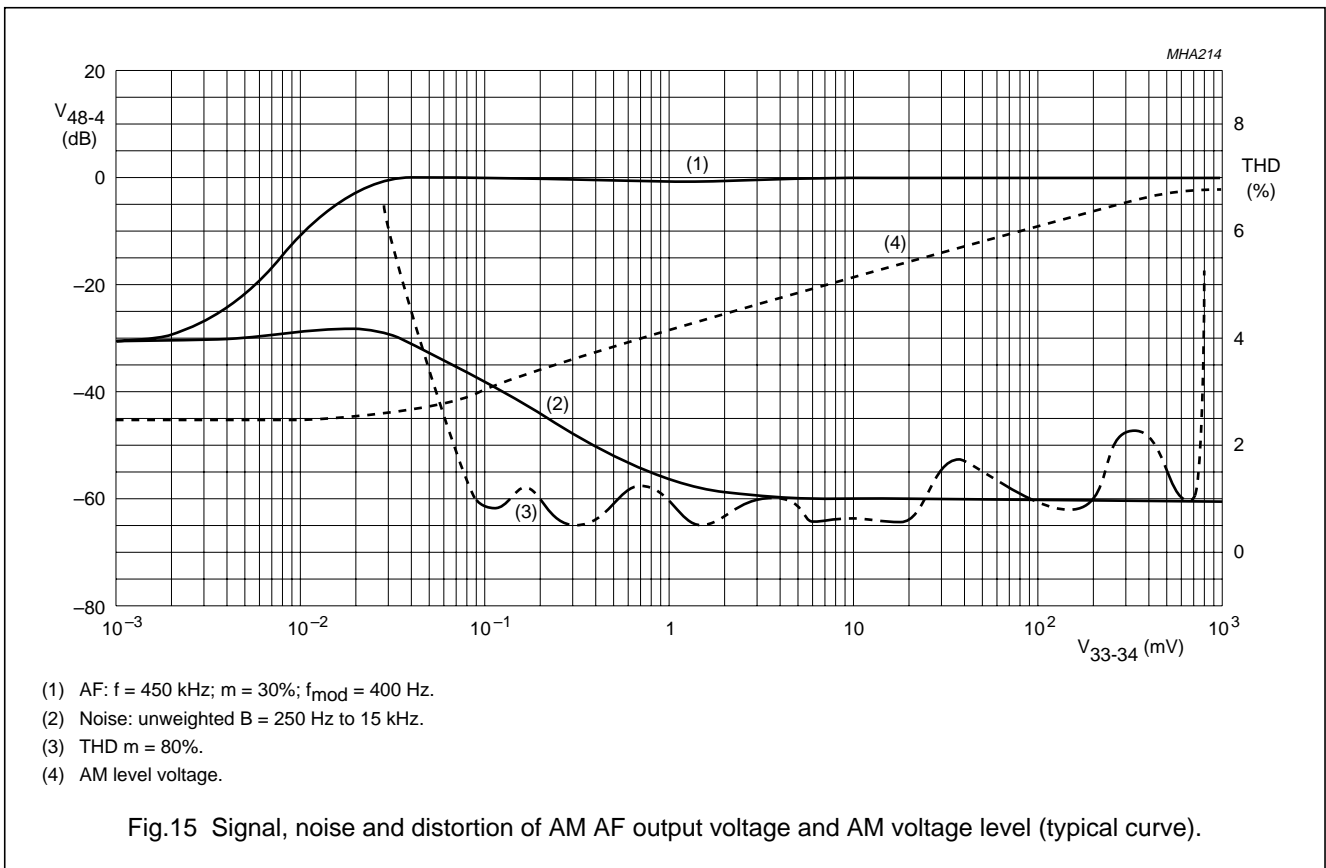
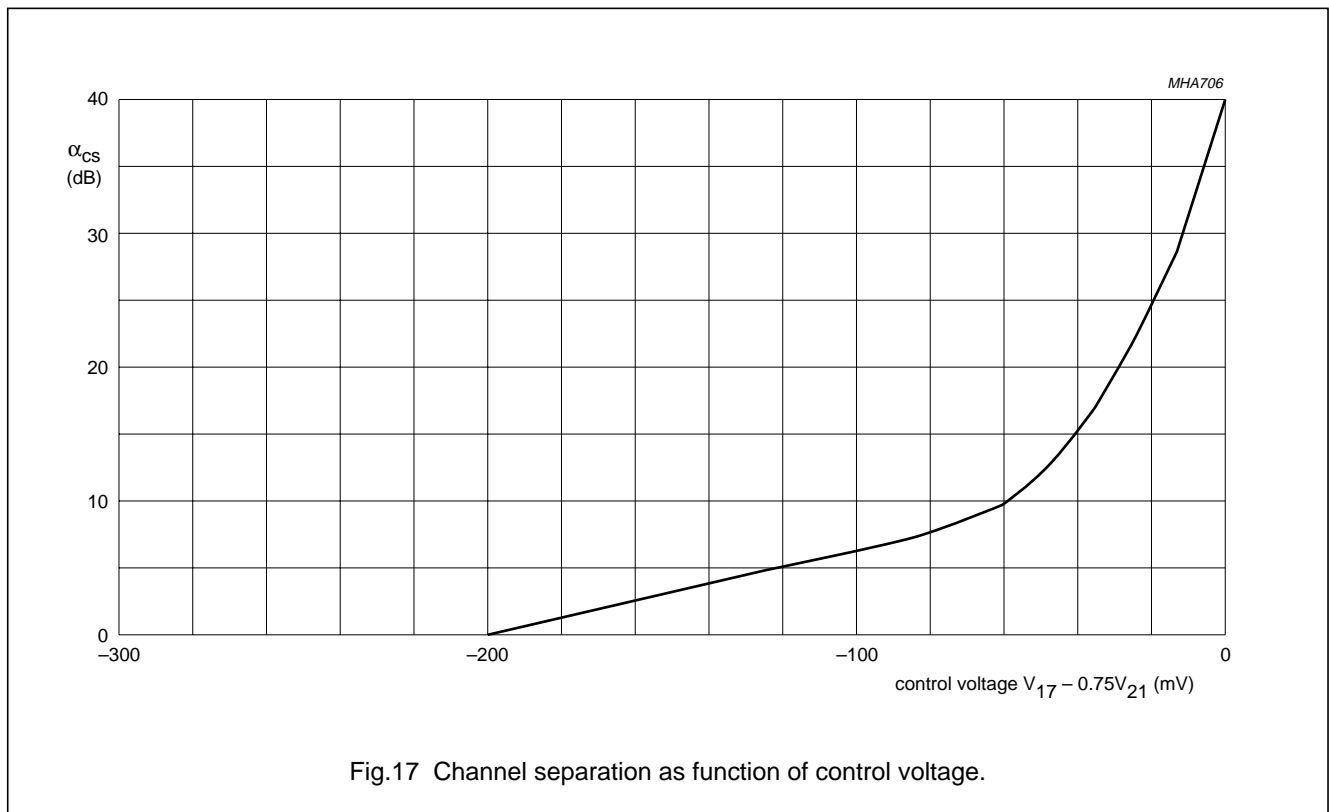
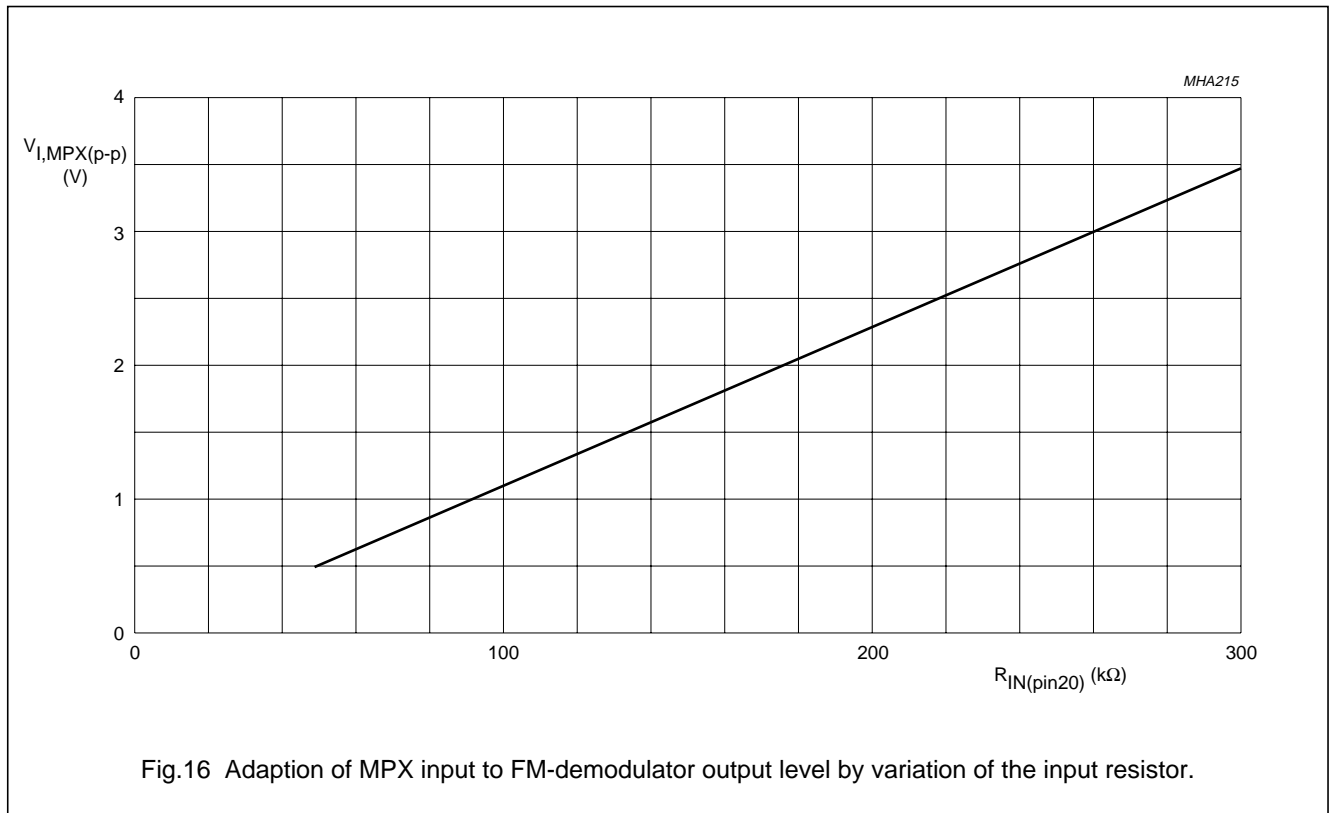

Fig.15 Signal, noise and distortion of AM AF output voltage and AM voltage level (typical curve).

In Car Entertainment (ICE) car radio

TEA6823T; TEA6825T



In Car Entertainment (ICE) car radio

TEA6823T; TEA6825T

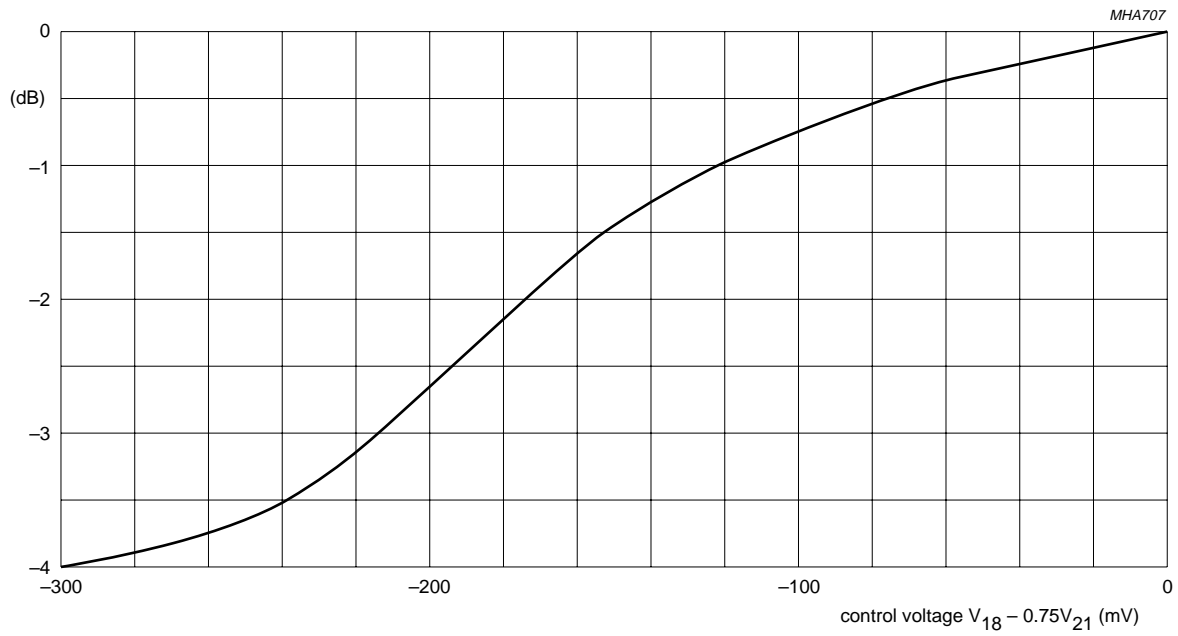
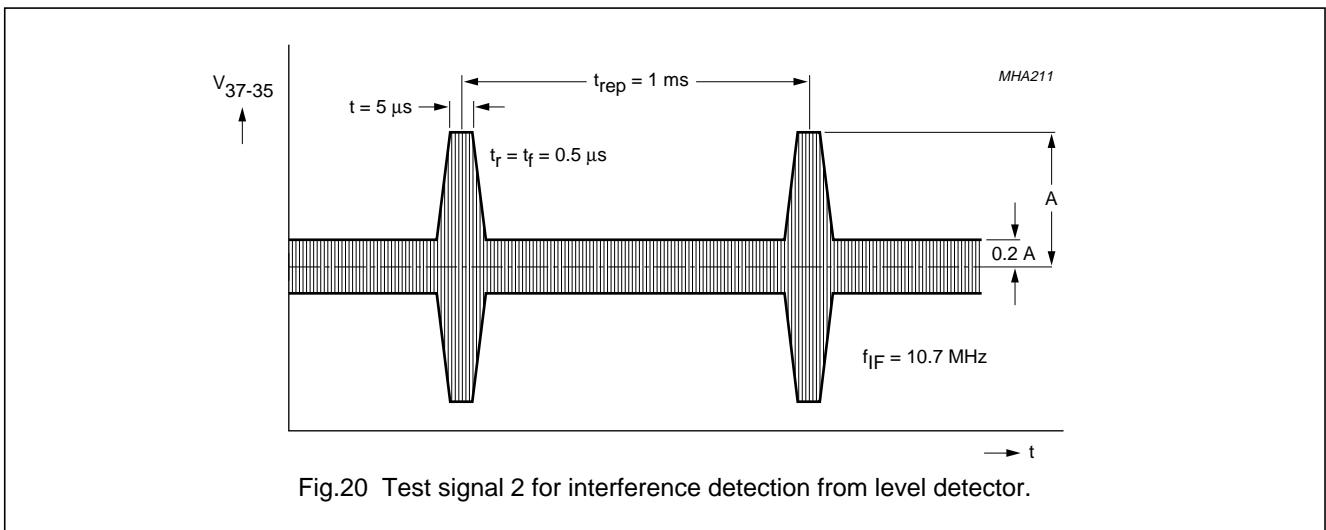
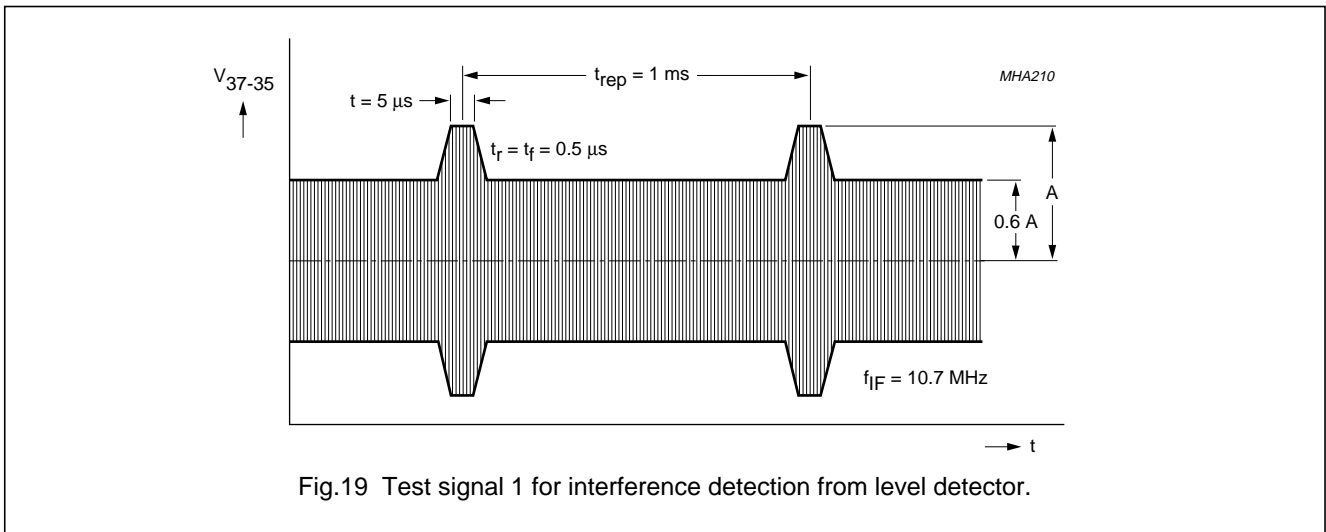

Fig.18 High-cut with $f_{mod} = 10$ kHz as function of control voltage.

In Car Entertainment (ICE) car radio

TEA6823T; TEA6825T



In Car Entertainment (ICE) car radio

TEA6823T; TEA6825T

I²C-BUS AND I²C-BUS CONTROLLED FUNCTIONS**I²C-bus specification**

The standard I²C-bus specification is expanded by the following definitions.

Structure of the I²C-bus logic: slave transceiver with auto increment and expansion to switch a direct transfer of all transmissions to an output for the radio front-end IC (TEA6810T respectively TEA6811T).

Subaddresses are not used.

DATA TRANSFER FOR THE TEA6823T AND THE TEA6825T

Data sequence:

- Address
- Byte 1
- Byte 2.

The data transfer may be in this order only. The transfer direction of the data bytes is defined by the LSB of the address.

The data becomes valid at the output of the internal latches with the acknowledge of each byte. A STOP condition after any byte can shorten transmission times.

When writing to the transceiver by using the STOP condition before completion of the whole transfer:

- The remaining bytes will contain the old information
- If the transfer of a byte was not completed, this byte is lost and the previous information is available.

DATA TRANSFER TO AN OUTPUT OF THE FRONT-END IC

A data bit in the transceiver of the TEA6823T or TEA6825T enables or disables a direct transfer of all transmissions to an interface stage for the front-end IC.

For a transmission to the front-end IC the address and the data format of the front-end IC has to be used.

Remark: the pull-up resistors for the front-end interface (pins 6 and 7) should not be connected to the 5 V supply voltage of the front-end IC, otherwise a bus pull-down (pin 53) can occur during switching off the front-end supply when the interface stage is enabled.

DATA TRANSFER TO THE IF IC

Data transfer to the IF IC (TEA6823T or TEA6825T) is independent of the state of interface stage for the front-end IC.

Table 1 Structure of the I²C-bus

DESCRIPTION	SPECIFICATION
Bus address of the TEA6823T and the TEA6825T	1100001X
Subaddress	not used
Hardware (pin) programmable address bits	not available
Default settings by power-on reset	data byte 1 bits 4 to 7 are set to logic 0; all other bits are random

Table 2 Data to be received by the IC for data byte 1

BIT	DESCRIPTION	RESULT
0	switch for mono	bit 0 = 1
	switch for stereo	bit 0 = 0
1	LSB reference frequency for synthesizer	
2	reference frequency for synthesizer	
3	MSB reference frequency for synthesizer	
4	tuning mute off	bit 4 = 1
	tuning mute on	bit 4 = 0
5	SDS/SDR hold off	bit 5 = 1
	SDS/SDR hold on	bit 5 = 0
6	radio mute off	bit 6 = 1
	radio mute on	bit 6 = 0
7	I ² C-bus to front-end ENABLED	bit 7 = 1
	I ² C-bus to front-end DISABLED	bit 7 = 0

Table 3 Reference frequency setting in data byte 1; see Table 1

BIT 3	BIT 2	BIT 1	FREQUENCY SETTING
0	0	0	3 kHz
0	0	1	5 kHz
0	1	0	10 kHz
0	1	1	15 kHz
1	0	0	25 kHz
1	0	1	50 kHz
1	1	0	not defined
1	1	1	not defined

In Car Entertainment (ICE) car radio

TEA6823T; TEA6825T

Table 4 Data to be received by the IC for data byte 2

BIT	DESCRIPTION	RESULT
0	AM/FM; AM mode	bit 0 = 0
	AM/FM; FM mode	bit 0 = 1
1	divider for AM mixer; divide by 2	bit 1 = 0
	divider for AM mixer; divide by 6	bit 1 = 1
2	measure time IF-count; 40 ms	bit 2 = 0
	measure time IF-count; 4 ms	bit 2 = 1
3	SDR off	bit 3 = 0
	SDR on	bit 3 = 1
4	IF-prescaler division rate; divide by 200	bit 4 = 0
	IF-prescaler division rate; divide by 25	bit 4 = 1
5	sensitivity unchanged	bit 5 = 0
	multi-path sensitivity switch; less sensitivity by an offset of $\Delta m = 10\%$	bit 5 = 1
6	temperature compensation of unweighted voltage level; temperature coefficient as specified in Chapter "Characteristics"	
	temperature compensation off	bit 6 = 0
	temperature compensation on	bit 6 = 1
7	noise blanker deactivated by high modulation	bit 7 = 0
	noise blanker not deactivated	bit 7 = 1

Table 5 Data to be transmitted by the IC for data byte 1;
note 1

BIT	DESCRIPTION
0	bit 1 level information
1	bit 2 level information
2	MSB (bit 3) level information
3	LSB multi-path information
4	multi-path information
5	MSB multi-path information
6	stereo pilot presence; bit 6 = 1
7	LSB (bit 0) level information

Note

1. The analog-to-digital conversion for multi-path and level will be done during a transmission of any address to the I²C-bus.

Table 6 Data to be transmitted by the IC for data byte 2

BIT	DESCRIPTION
0	LSB of the IF-counter
1	IF-counter
2	IF-counter
3	IF-counter
4	IF-counter
5	IF-counter
6	IF-counter
7	MSB of the IF-counter

REFERENCED FREQUENCY GENERATION

Table 7 Division ratios

DIVISION RATIO	REFERENCE FREQUENCY (kHz) ⁽¹⁾
20500	3
12300	5
6150	10
4100	15
2460	25
1230	50

Note

1. All specified frequencies are valid for a crystal oscillator frequency of 61.5 MHz.

In Car Entertainment (ICE) car radio

TEA6823T; TEA6825T

Table 8 Output signal of reference frequency divider

SYMBOL	PARAMETER	MIN.	TYP.	MAX.	UNIT
$V_{10-11(p-p)}$	differential output voltage (peak-to-peak value)	0.3	0.4	0.5	V
$V_{10-4(p-p)}$; $V_{11-4(p-p)}$	single-ended output voltage (peak-to-peak value)	0.15	0.2	0.3	V
C_{10-4} ; C_{11-4}	output capacitance	–	–	4	pF
R_{10-52} ; R_{11-52}	output resistance	800	1000	1200	Ω

IF-COUNTER

Table 9 IF-counter sensitivity

SYMBOL	PARAMETER	CONDITIONS	MIN.	UNIT
V_{33-34}	IF-counter sensitivity	AM mode; $m = 0$	200	μV
V_{37-35}	IF-counter sensitivity	FM mode	200	μV

AM counting windows are 4 or 40 ms. FM counting windows are 4 or 40 ms. AM counting resolution is 250 or 25 Hz. FM counting resolution is 5 kHz, 625 Hz, 50 kHz or 6.25 kHz. AM-IF-prescaler is divisible by 1. FM-IF-prescaler is divisible by 25 or 200.

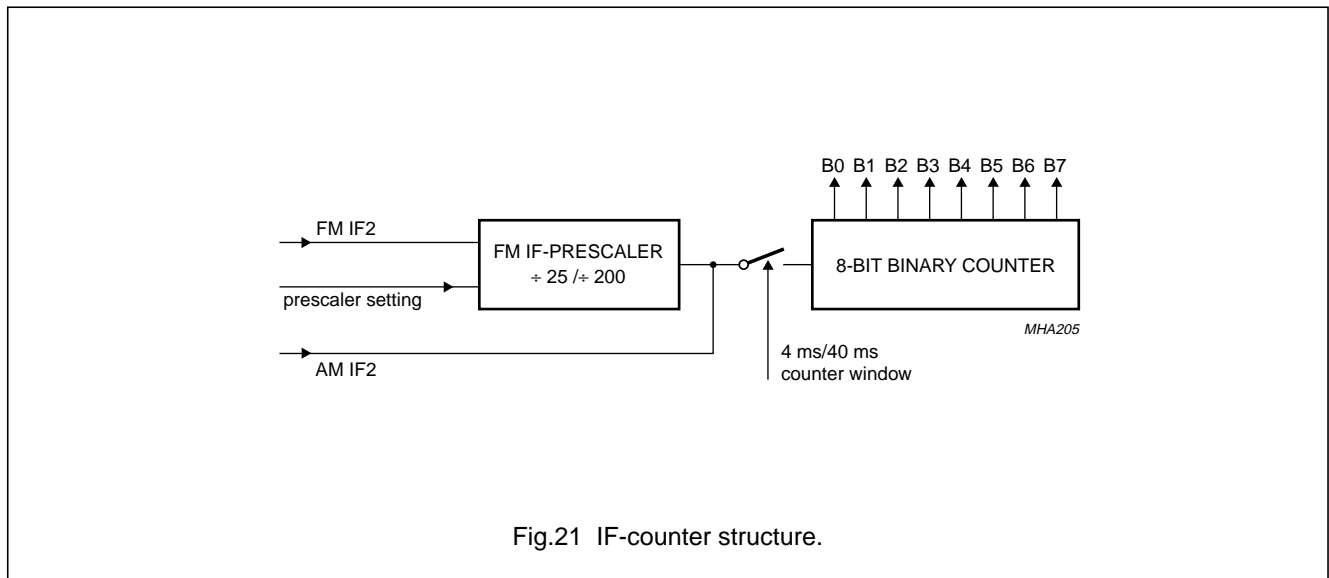

In Car Entertainment (ICE) car radio

TEA6823T; TEA6825T

*IF-counter read out***IF-counter read out as a function of FM or AM position, counter window and prescaler setting**

FM/AM	PRESCALER RATIO	WINDOW (ms)	f _{IF} (kHz)	READ OUT	RESOLUTION (Hz/count)	RANGE (kHz)	
						MIN.	MAX.
FM	200	4	10700	D6H	50000	4300	17050
FM	200	40	10700	5CH	5000	10065	11335
FM	25	4	10700	B0H	6250	9906.25	11493.75
FM ⁽¹⁾	25	40	10700	E0H	625	10620.63	10779.38
AM	1	4	450	08H	250	418.25	481.75
AM ⁽¹⁾	1	40	450	50H	25	446.83	453.18

Note

1. In position FM with a prescaler ratio of 25, counter window of 40 ms and in position AM with 40 ms counter window ambiguous counting results within the IF filter bandwidth are obtained. The counting range is 127 counts above and 127 counts below the nominal IF of 10.7 MHz for FM and 450 kHz for AM.

The IF-count windows are valid for a crystal oscillator frequency of 61.5 MHz.

The FM/AM switching is carried out by bit 0 of byte 2 of the received data of the IC.

The IF-counter operates continuously.

The IF-counter and window-counter will be reset when the I²C-bus logic detects the address of the IC. This disables changes in the latches for the IF-count, while reading this value. If the transmission to the front-end IC is disabled after the synthesizer loop of the TEA6810T/TEA6811T front-end IC has locked for a new frequency, the IF-count will be available after the set measuring time.

The IF-counter starts at 0. The IF-counter output are the **8 least significant bits** of the counting result.

In Car Entertainment (ICE) car radio

TEA6823T; TEA6825T

INTERNAL CIRCUITRY

Table 10 Equivalent pin circuits and pin voltages

PIN	SYMBOL	DC VOLTAGE (V)		EQUIVALENT CIRCUIT
		AM	FM	
1	QDET1	open-circuit	4.0	
2	QDET2	open-circuit	4.0	
3	TSWITCH	open-circuit	0.4 to 6.0	
4	AGND	–	–	
5	V _{DDA1}	5.0	5.0	
6	HFBUS1	5.0	5.0	
7	HFBUS2	5.0	5.0	

In Car Entertainment (ICE) car radio

TEA6823T; TEA6825T

PIN	SYMBOL	DC VOLTAGE (V)		EQUIVALENT CIRCUIT
		AM	FM	
8	XTAL1	4.1	4.1	
9	XTAL2	4.1	4.1	
10	$f_{ref(p)}$	4.9	4.9	
11	$f_{ref(n)}$	4.9	4.9	
12	I_{ref}	4.3	4.3	
13	FMIF1IN1	2.3	2.3	
14	FMIF1IN2	2.3	2.3	

In Car Entertainment (ICE) car radio

TEA6823T; TEA6825T

PIN	SYMBOL	DC VOLTAGE (V)		EQUIVALENT CIRCUIT
		AM	FM	
15	TSDR	0.7 to 5.5	0.7 to 5.5	
16	TSDS	0.7 to 5.5	0.7 to 5.5	
17	V _{SDS}	3.0 to 5.5	3.0 to 5.5	
18	V _{SDR}	3.0 to 5.5	3.0 to 5.5	
19	FMIF2OUT1	8.5	8.5	
20	FMIF2OUT2	8.5	8.5	

In Car Entertainment (ICE) car radio

TEA6823T; TEA6825T

PIN	SYMBOL	DC VOLTAGE (V)		EQUIVALENT CIRCUIT
		AM	FM	
21	V _{ref}	5.1	5.1	
22	AMIF2OUT1	8.5	8.5	
23	AMIF2OUT2	8.5	8.5	
24	FMAMDEC	3.0	2.5	
25	PHASEDET	2.8 to 7.2	2.8 to 7.2	
26	PILDET	0.4	0.4 to 7.0	

In Car Entertainment (ICE) car radio

TEA6823T; TEA6825T

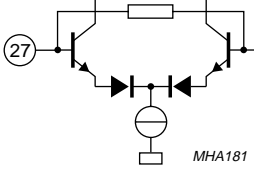
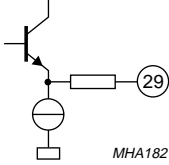
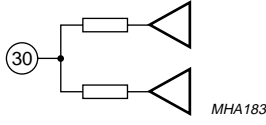
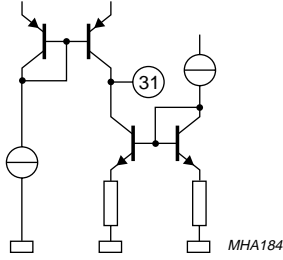
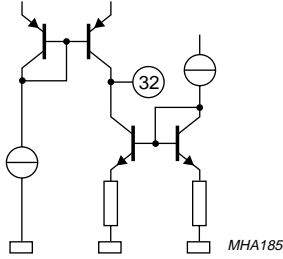
PIN	SYMBOL	DC VOLTAGE (V)		EQUIVALENT CIRCUIT
		AM	FM	
27	FMAM10.7	3.0	2.5	
28	V _{DDA2}	8.5	8.5	
29	FMIFAMPOUT	6.0	6.0	
30	AFGND	3.6	3.6	
31	DEEMPHR	2.3	2.3	
32	DEEMPHL	2.3	2.3	

In Car Entertainment (ICE) car radio

TEA6823T; TEA6825T

PIN	SYMBOL	DC VOLTAGE (V)		EQUIVALENT CIRCUIT
		AM	FM	
33	AMIF2IN1	2.7	0.7	
34	AMIF2IN2	2.7	0.7	
35	FMIN2	0.7	2.7	
36	DCFEED	2.7	2.7	
37	FMIN1	0.7	2.7	
38	LEVELADJ	2.6	2.6	

In Car Entertainment (ICE) car radio

TEA6823T; TEA6825T

PIN	SYMBOL	DC VOLTAGE (V)		EQUIVALENT CIRCUIT
		AM	FM	
39	C _{AFC}	1.0 to 2.2	1.0 to 7.0	
40	MPBUF	0.7 to 6.0	0.7 to 6.0	
41	OUTLEFT	3.6	3.6	
42	FMSTOP	0 to 5.2	0 to 5.2	
43	RDS/AMSTOP	0 to 5.2	3.0	
44	OUTRIGHT	3.6	3.6	

In Car Entertainment (ICE) car radio

TEA6823T; TEA6825T

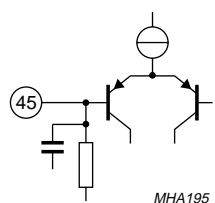
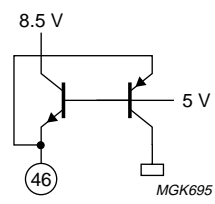
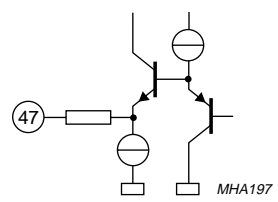
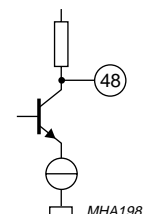
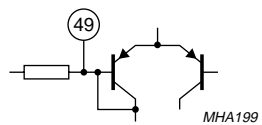
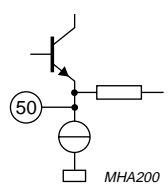
PIN	SYMBOL	DC VOLTAGE (V)		EQUIVALENT CIRCUIT
		AM	FM	
45	MPXIN	2.8	2.8	 <p>MHA195</p>
46	THRES	4.3/5.7	4.3/5.7	 <p>MGK695</p>
47	MPXOUT	0	3.0	 <p>MHA197</p>
48	AMAFOUT	3.7	4.8	 <p>MHA198</p>
49	V _{mute/AML}	1.0 to 5.5	1.0 to 5.5	 <p>MHA199</p>
50	LEVELUNWEIG	1.0 to 7.0	1.0 to 7.0	 <p>MHA200</p>

In Car Entertainment (ICE) car radio

TEA6823T; TEA6825T

PIN	SYMBOL	DC VOLTAGE (V)		EQUIVALENT CIRCUIT
		AM	FM	
51	IAC _{CONTR}	0	6.0	
52	V _{DDD}	5.0	5.0	
53	SDA	5.0	5.0	
54	SCL	5.0	5.0	
55	DGND	0	0	
56	V _{DDA3}	8.5	8.5	

In Car Entertainment (ICE) car radio

TEA6823T; TEA6825T

APPLICATION INFORMATION

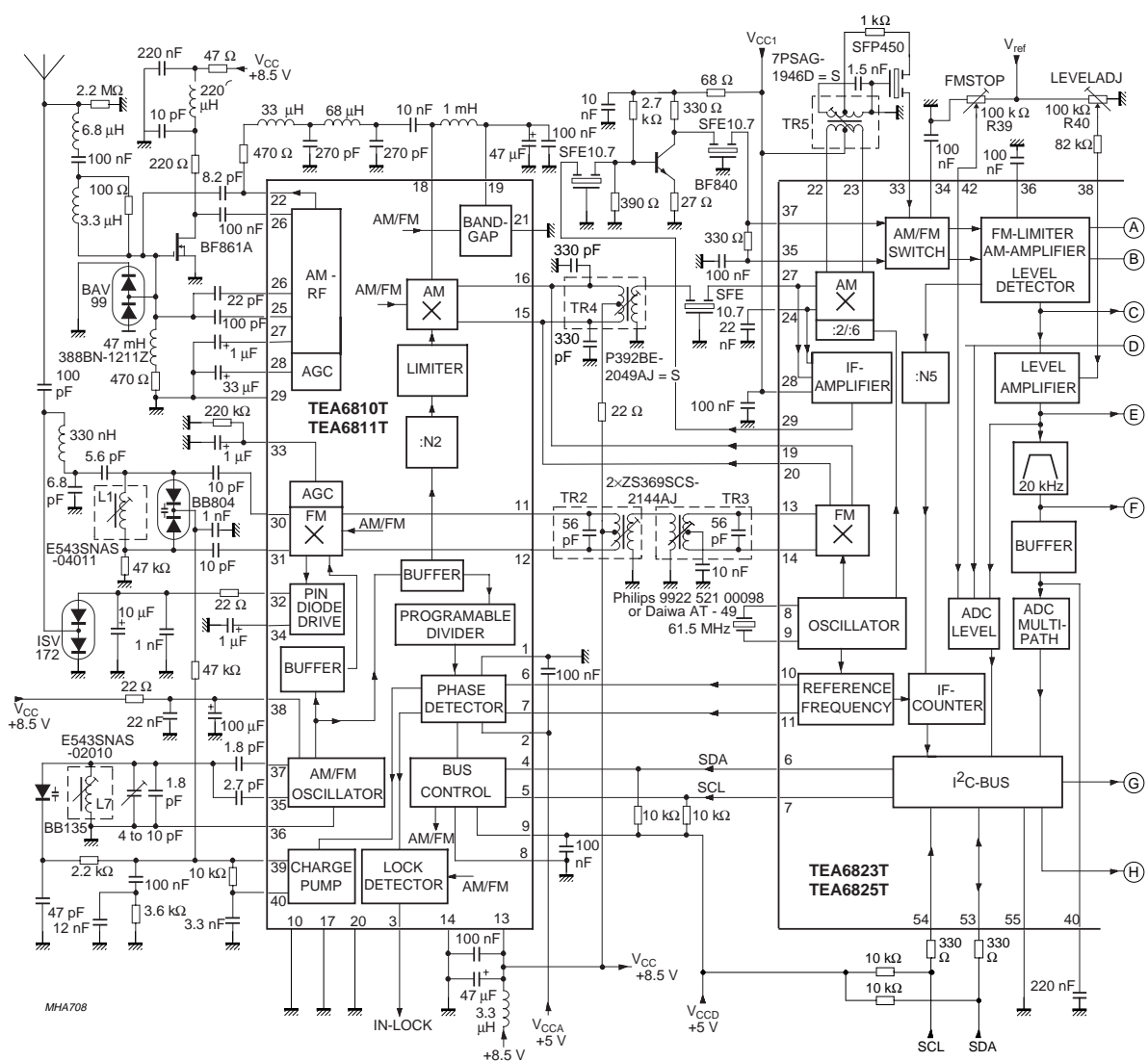

Time constant control: slow or fast attack and decay time constants for soft mute, mono/stereo and high-cut control can be chosen by connecting pin 3 to GND or pin 21.

Fig.22 ICE application diagram (continued in Fig.23).

In Car Entertainment (ICE) car radio

TEA6823T; TEA6825T

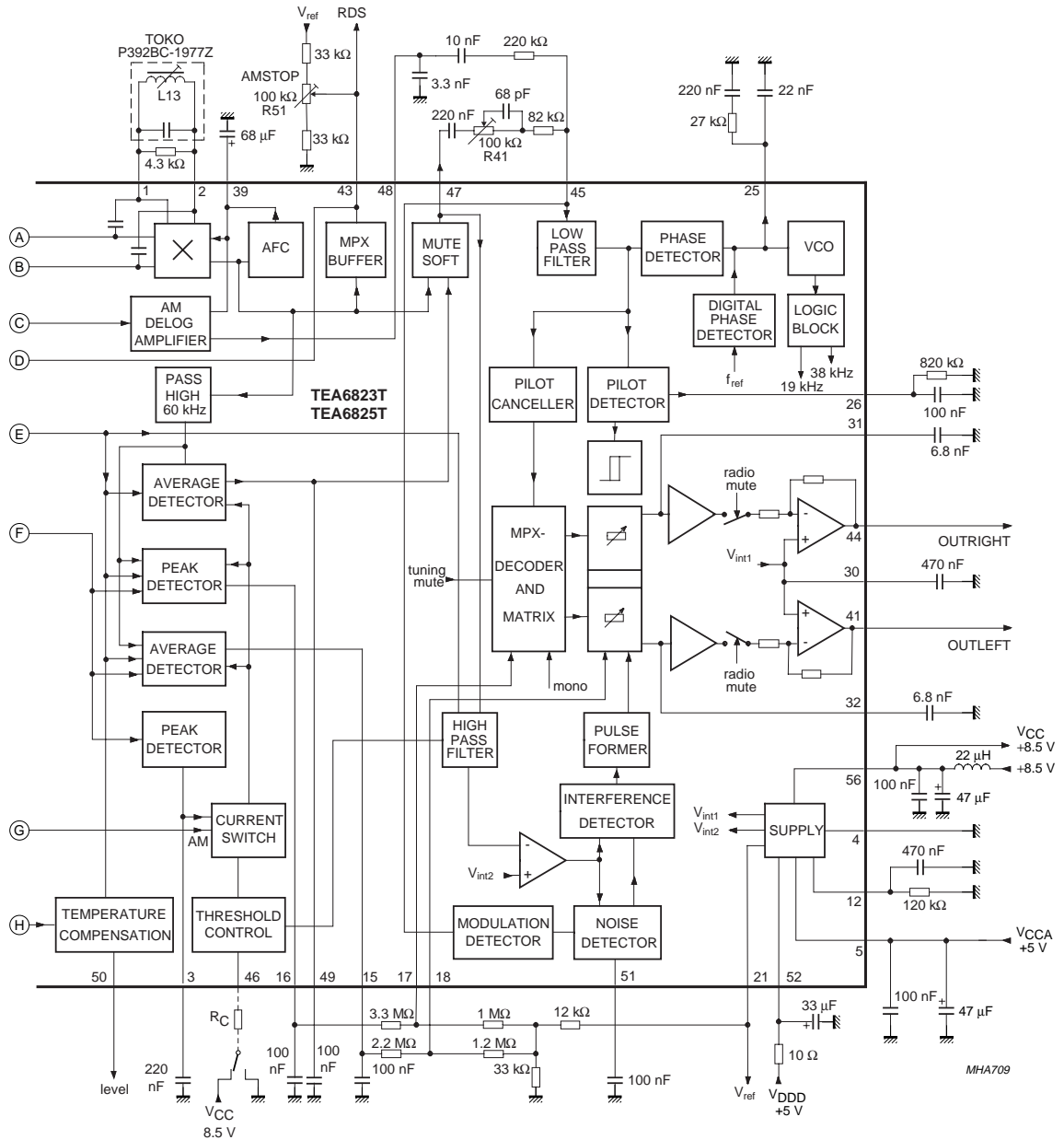

Fig.23 ICE application diagram (continued from Fig.22).

In Car Entertainment (ICE) car radio

TEA6823T; TEA6825T

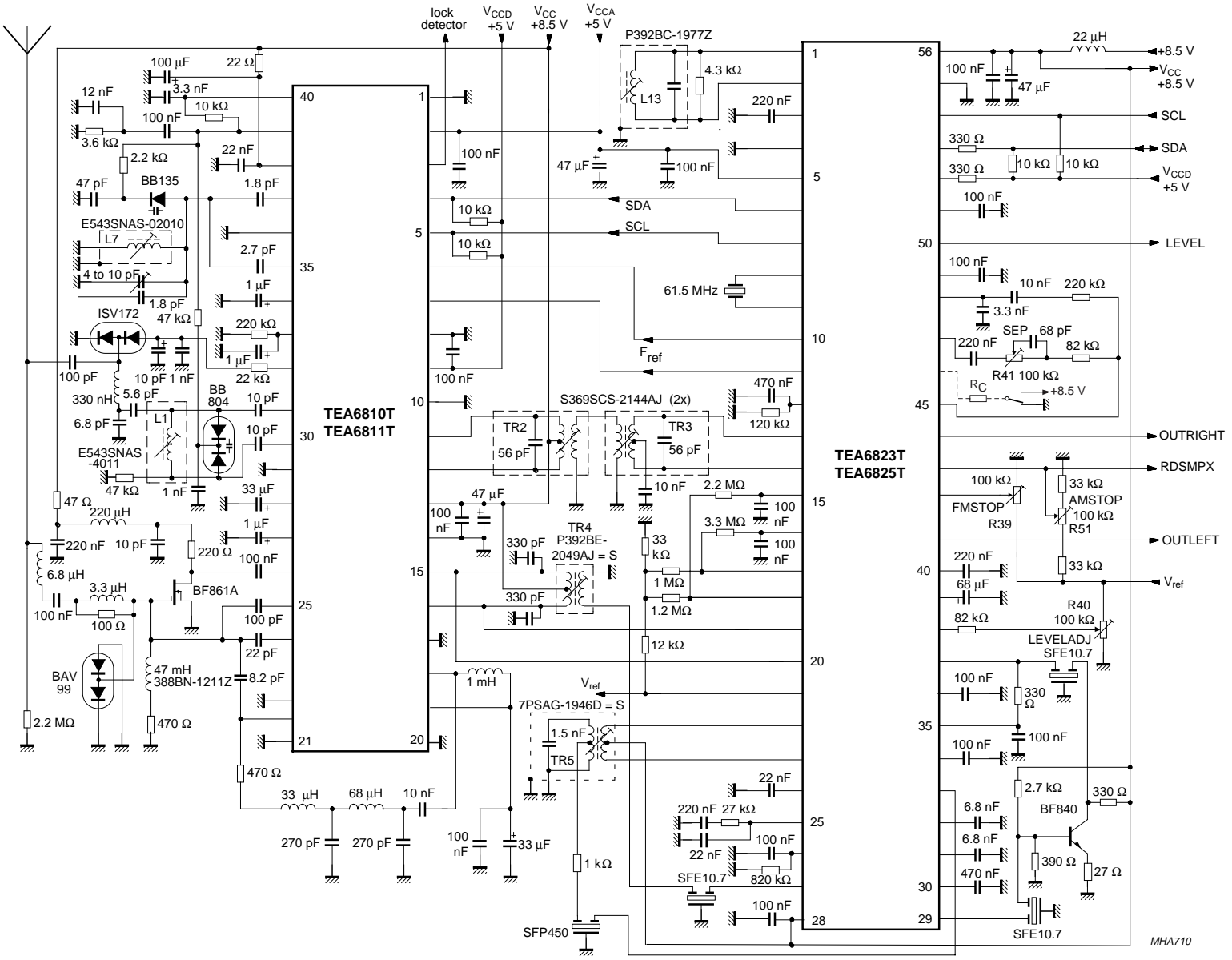

Fig.24 AM/FM car radio receiver with TEA6810T and TEA6825T or TEA6811T and TEA6823T.

In Car Entertainment (ICE) car radio

TEA6823T; TEA6825T

PACKAGE OUTLINES

VSO56: plastic very small outline package; 56 leads

SOT190-1

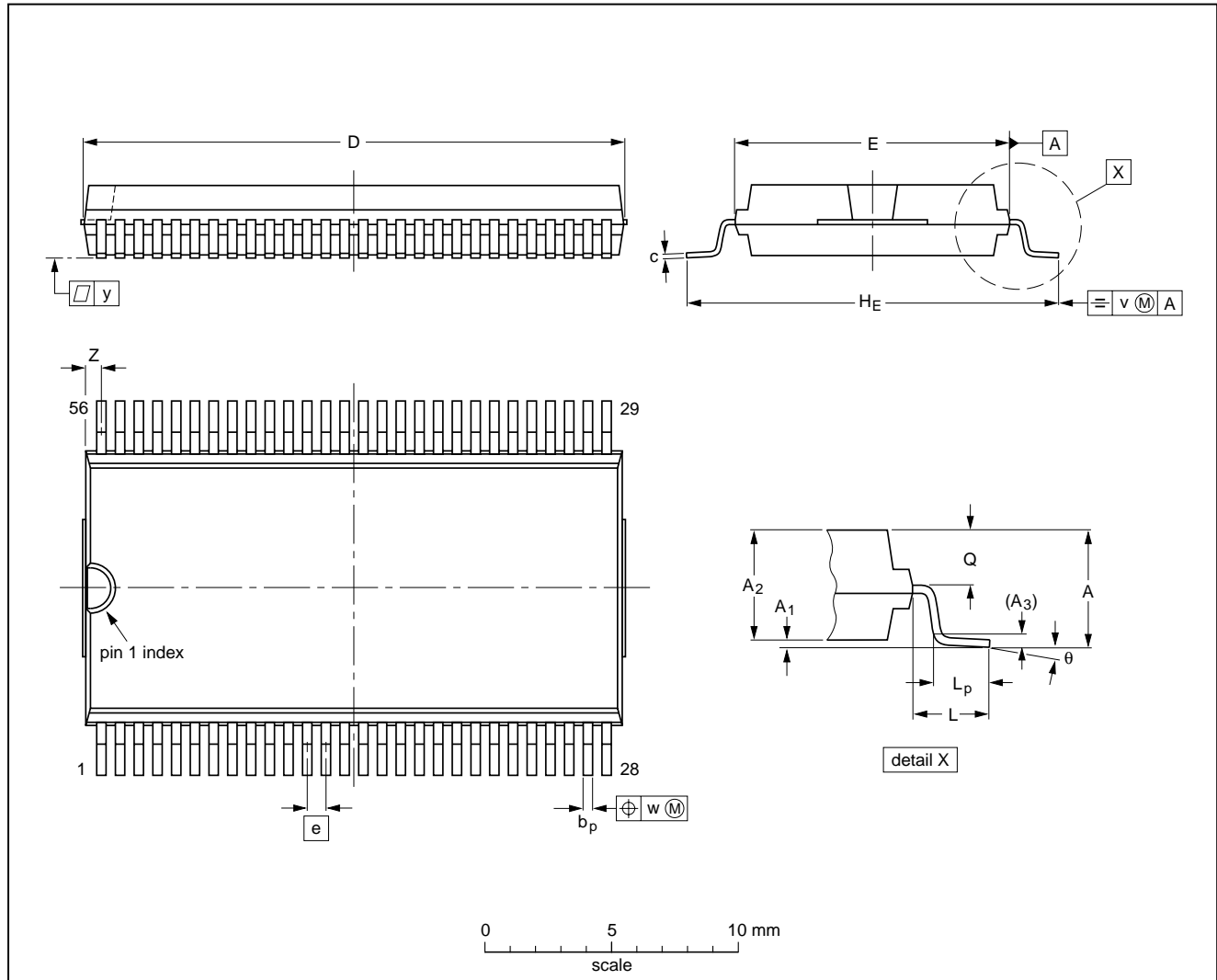

DIMENSIONS (inch dimensions are derived from the original mm dimensions)

UNIT	A max.	A ₁	A ₂	A ₃	b _p	c	D ⁽¹⁾	E ⁽²⁾	e	H _E	L	L _p	Q	v	w	y	z ⁽¹⁾	θ
mm	3.3	0.3 0.1	3.0 2.8	0.25	0.42 0.30	0.22 0.14	21.65 21.35	11.1 11.0	0.75	15.8 15.2	2.25	1.6 1.4	1.45 1.30	0.2	0.1	0.1	0.90 0.55	7° 0°
inches	0.13	0.012 0.004	0.12 0.11	0.01	0.017 0.012	0.0087 0.0055	0.85 0.84	0.44 0.43	0.0295	0.62 0.60	0.089	0.063 0.055	0.057 0.051	0.008	0.004	0.004	0.035 0.022	

Note

1. Plastic or metal protrusions of 0.3 mm maximum per side are not included.
2. Plastic interlead protrusions of 0.25 mm maximum per side are not included.

OUTLINE VERSION	REFERENCES				EUROPEAN PROJECTION	ISSUE DATE
	IEC	JEDEC	EIAJ			
SOT190-1						96-04-02 97-08-11

In Car Entertainment (ICE) car radio

TEA6823T; TEA6825T

VSO56: plastic very small outline package; 56 leads; face down

SOT190-2

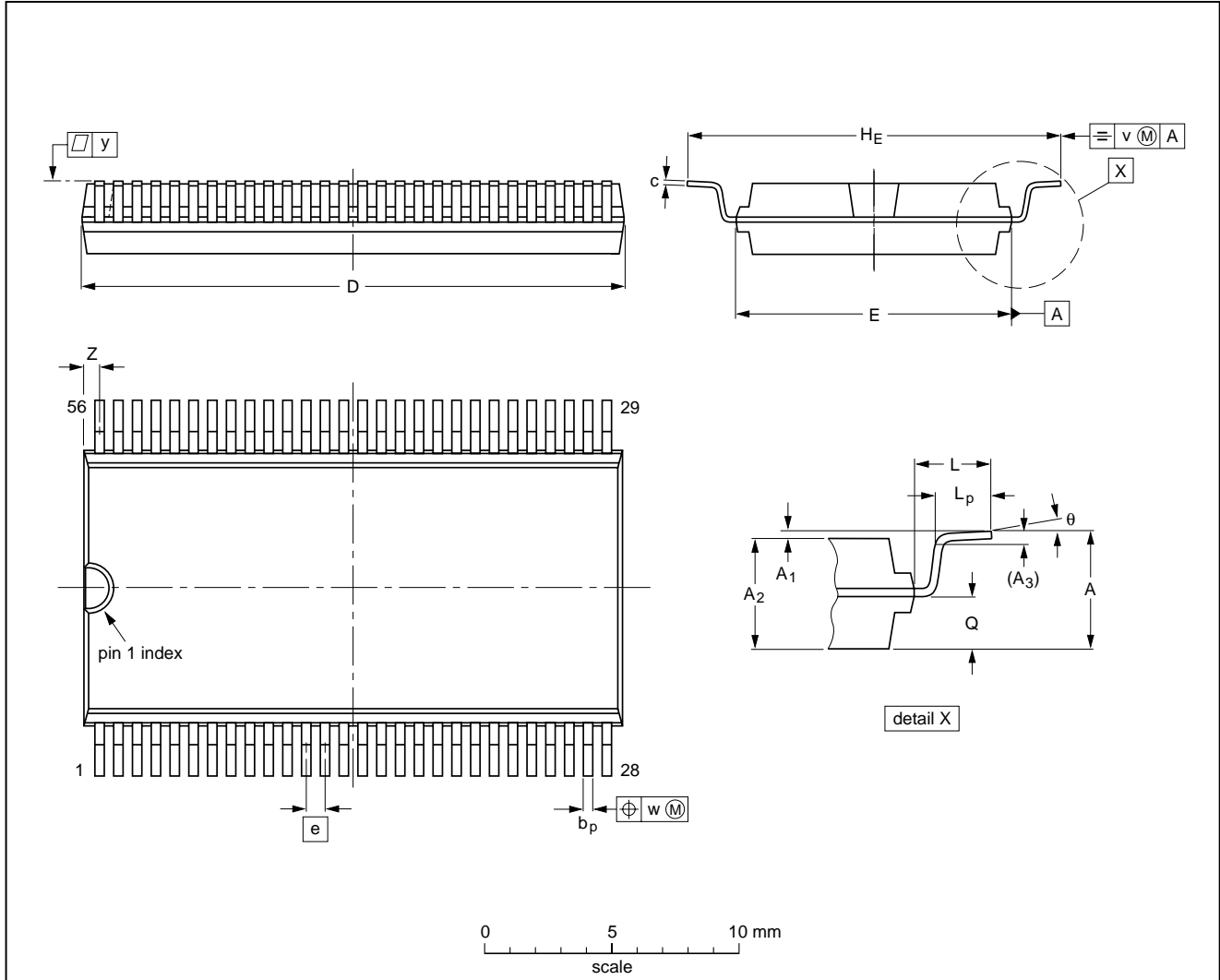

DIMENSIONS (inch dimensions are derived from the original mm dimensions)

UNIT	A max.	A ₁	A ₂	A ₃	b _p	c	D ⁽¹⁾	E ⁽²⁾	e	H _E	L	L _p	Q	v	w	y	Z ⁽¹⁾	θ
mm	3.3	0.3 0.1	3.0 2.8	0.25	0.42 0.30	0.22 0.14	21.65 21.35	11.1 11.0	0.75	15.8 15.2	2.25	1.6 1.4	1.45 1.30	0.2	0.1	0.1	0.90 0.55	7° 0°
inches	0.13	0.012 0.004	0.12 0.11	0.01	0.017 0.012	0.0087 0.0055	0.85 0.84	0.44 0.43	0.0295	0.62 0.60	0.089	0.063 0.055	0.057 0.051	0.008	0.004	0.004	0.035 0.022	

Note

1. Plastic or metal protrusions of 0.3 mm maximum per side are not included.
2. Plastic interlead protrusions of 0.25 mm maximum per side are not included.

OUTLINE VERSION	REFERENCES				EUROPEAN PROJECTION	ISSUE DATE
	IEC	JEDEC	EIAJ			
SOT190-2						96-04-02 97-08-11

In Car Entertainment (ICE) car radio

TEA6823T; TEA6825T

SOLDERING

Introduction

There is no soldering method that is ideal for all IC packages. Wave soldering is often preferred when through-hole and surface mounted components are mixed on one printed-circuit board. However, wave soldering is not always suitable for surface mounted ICs, or for printed-circuits with high population densities. In these situations reflow soldering is often used.

This text gives a very brief insight to a complex technology. A more in-depth account of soldering ICs can be found in our *"Data Handbook IC26; Integrated Circuit Packages"* (order code 9398 652 90011).

Reflow soldering

Reflow soldering techniques are suitable for all VSO packages.

Reflow soldering requires solder paste (a suspension of fine solder particles, flux and binding agent) to be applied to the printed-circuit board by screen printing, stencilling or pressure-syringe dispensing before package placement.

Several techniques exist for reflowing; for example, thermal conduction by heated belt. Dwell times vary between 50 and 300 seconds depending on heating method. Typical reflow temperatures range from 215 to 250 °C.

Preheating is necessary to dry the paste and evaporate the binding agent. Preheating duration: 45 minutes at 45 °C.

Wave soldering

Wave soldering techniques can be used for all VSO packages if the following conditions are observed:

- A double-wave (a turbulent wave with high upward pressure followed by a smooth laminar wave) soldering technique should be used.
- The longitudinal axis of the package footprint must be parallel to the solder flow.
- The package footprint must incorporate solder thieves at the downstream end.

During placement and before soldering, the package must be fixed with a droplet of adhesive. The adhesive can be applied by screen printing, pin transfer or syringe dispensing. The package can be soldered after the adhesive is cured.

Maximum permissible solder temperature is 260 °C, and maximum duration of package immersion in solder is 10 seconds, if cooled to less than 150 °C within 6 seconds. Typical dwell time is 4 seconds at 250 °C.

A mildly-activated flux will eliminate the need for removal of corrosive residues in most applications.

Repairing soldered joints

Fix the component by first soldering two diagonally-opposite end leads. Use only a low voltage soldering iron (less than 24 V) applied to the flat part of the lead. Contact time must be limited to 10 seconds at up to 300 °C. When using a dedicated tool, all other leads can be soldered in one operation within 2 to 5 seconds between 270 and 320 °C.

In Car Entertainment (ICE) car radio

TEA6823T; TEA6825T

DEFINITIONS

Data sheet status	
Objective specification	This data sheet contains target or goal specifications for product development.
Preliminary specification	This data sheet contains preliminary data; supplementary data may be published later.
Product specification	This data sheet contains final product specifications.
Limiting values	
Limiting values given are in accordance with the Absolute Maximum Rating System (IEC 134). Stress above one or more of the limiting values may cause permanent damage to the device. These are stress ratings only and operation of the device at these or at any other conditions above those given in the Characteristics sections of the specification is not implied. Exposure to limiting values for extended periods may affect device reliability.	
Application information	
Where application information is given, it is advisory and does not form part of the specification.	

LIFE SUPPORT APPLICATIONS

These products are not designed for use in life support appliances, devices, or systems where malfunction of these products can reasonably be expected to result in personal injury. Philips customers using or selling these products for use in such applications do so at their own risk and agree to fully indemnify Philips for any damages resulting from such improper use or sale

PURCHASE OF PHILIPS I²C COMPONENTS

Purchase of Philips I²C components conveys a license under the Philips' I²C patent to use the components in the I²C system provided the system conforms to the I²C specification defined by Philips. This specification can be ordered using the code 9398 393 40011.

In Car Entertainment (ICE) car radio

TEA6823T; TEA6825T

NOTES

Philips Semiconductors – a worldwide company

Argentina: see South America

Australia: 34 Waterloo Road, NORTH RYDE, NSW 2113,
Tel. +61 2 9805 4455, Fax. +61 2 9805 4466

Austria: Computerstr. 6, A-1101 WIEN, P.O. Box 213, Tel. +43 160 1010,
Fax. +43 160 101 1210

Belarus: Hotel Minsk Business Center, Bld. 3, r. 1211, Volodarski Str. 6,
220050 MINSK, Tel. +375 172 200 733, Fax. +375 172 200 773

Belgium: see The Netherlands

Brazil: see South America

Bulgaria: Philips Bulgaria Ltd., Energoproject, 15th floor,
51 James Bourchier Blvd., 1407 SOFIA,
Tel. +359 2 689 211, Fax. +359 2 689 102

Canada: PHILIPS SEMICONDUCTORS/COMPONENTS,
Tel. +1 800 234 7381

China/Hong Kong: 501 Hong Kong Industrial Technology Centre,
72 Tat Chee Avenue, Kowloon Tong, HONG KONG,
Tel. +852 2319 7888, Fax. +852 2319 7700

Colombia: see South America

Czech Republic: see Austria

Denmark: Prags Boulevard 80, PB 1919, DK-2300 COPENHAGEN S,
Tel. +45 32 88 2636, Fax. +45 31 57 0044

Finland: Sinikalliontie 3, FIN-02630 ESPOO,
Tel. +358 9 615800, Fax. +358 9 61580920

France: 51 Rue Carnot, BP317, 92156 SURESNES Cedex,
Tel. +33 1 40 99 6161, Fax. +33 1 40 99 6427

Germany: Hammerbrookstraße 69, D-20097 HAMBURG,
Tel. +49 40 23 53 60, Fax. +49 40 23 536 300

Greece: No. 15, 25th March Street, GR 17778 TAVROS/ATHENS,
Tel. +30 1 4894 339/239, Fax. +30 1 4814 240

Hungary: see Austria

India: Philips INDIA Ltd, Band Box Building, 2nd floor,
254-D, Dr. Annie Besant Road, Worli, MUMBAI 400 025,
Tel. +91 22 493 8541, Fax. +91 22 493 0966

Indonesia: see Singapore

Ireland: Newstead, Clonskeagh, DUBLIN 14,
Tel. +353 1 7640 000, Fax. +353 1 7640 200

Israel: RAPAC Electronics, 7 Kehilat Saloniki St, PO Box 18053,
TEL AVIV 61180, Tel. +972 3 645 0444, Fax. +972 3 649 1007

Italy: PHILIPS SEMICONDUCTORS, Piazza IV Novembre 3,
20124 MILANO, Tel. +39 2 6752 2531, Fax. +39 2 6752 2557

Japan: Philips Bldg 13-37, Kohnan 2-chome, Minato-ku, TOKYO 108,
Tel. +81 3 3740 5130, Fax. +81 3 3740 5077

Korea: Philips House, 260-199 Itaewon-dong, Yongsan-ku, SEOUL,
Tel. +82 2 709 1412, Fax. +82 2 709 1415

Malaysia: No. 76 Jalan Universiti, 46200 PETALING JAYA, SELANGOR,
Tel. +60 3 750 5214, Fax. +60 3 757 4880

Mexico: 5900 Gateway East, Suite 200, EL PASO, TEXAS 79905,
Tel. +9-5 800 234 7381

Middle East: see Italy

Netherlands: Postbus 90050, 5600 PB EINDHOVEN, Bldg. VB,
Tel. +31 40 27 82785, Fax. +31 40 27 88399

New Zealand: 2 Wagener Place, C.P.O. Box 1041, AUCKLAND,
Tel. +64 9 849 4160, Fax. +64 9 849 7811

Norway: Box 1, Manglerud 0612, OSLO,
Tel. +47 22 74 8000, Fax. +47 22 74 8341

Philippines: Philips Semiconductors Philippines Inc.,
106 Valero St. Salcedo Village, P.O. Box 2108 MCC, MAKATI,
Metro MANILA, Tel. +63 2 816 6380, Fax. +63 2 817 3474

Poland: Ul. Lukiska 10, PL 04-123 WARSZAWA,
Tel. +48 22 612 2831, Fax. +48 22 612 2327

Portugal: see Spain

Romania: see Italy

Russia: Philips Russia, Ul. Usatcheva 35A, 119048 MOSCOW,
Tel. +7 095 755 6918, Fax. +7 095 755 6919

Singapore: Lorong 1, Toa Payoh, SINGAPORE 1231,
Tel. +65 350 2538, Fax. +65 251 6500

Slovakia: see Austria

Slovenia: see Italy

South Africa: S.A. PHILIPS Pty Ltd., 195-215 Main Road Martindale,
2092 JOHANNESBURG, P.O. Box 7430 Johannesburg 2000,
Tel. +27 11 470 5911, Fax. +27 11 470 5494

South America: Al. Vicente Pinzon, 173, 6th floor,
04547-130 SÃO PAULO, SP, Brazil,
Tel. +55 11 821 2333, Fax. +55 11 821 2382

Spain: Balmes 22, 08007 BARCELONA,
Tel. +34 3 301 6312, Fax. +34 3 301 4107

Sweden: Kottbygatan 7, Akalla, S-16485 STOCKHOLM,
Tel. +46 8 632 2000, Fax. +46 8 632 2745

Switzerland: Allmendstrasse 140, CH-8027 ZÜRICH,
Tel. +41 1 488 2686, Fax. +41 1 488 3263

Taiwan: Philips Semiconductors, 6F, No. 96, Chien Kuo N. Rd., Sec. 1,
TAIPEI, Taiwan Tel. +886 2 2134 2865, Fax. +886 2 2134 2874

Thailand: PHILIPS ELECTRONICS (THAILAND) Ltd.,
209/2 Sanpavuth-Bangna Road Prakanong, BANGKOK 10260,
Tel. +66 2 745 4090, Fax. +66 2 398 0793

Turkey: Talatpasa Cad. No. 5, 80640 GÜLTEPE/ISTANBUL,
Tel. +90 212 279 2770, Fax. +90 212 282 6707

Ukraine: PHILIPS UKRAINE, 4 Patrice Lumumba str., Building B, Floor 7,
252042 KIEV, Tel. +380 44 264 2776, Fax. +380 44 268 0461

United Kingdom: Philips Semiconductors Ltd., 276 Bath Road, Hayes,
MIDDLESEX UB3 5BX, Tel. +44 181 730 5000, Fax. +44 181 754 8421

United States: 811 East Arques Avenue, SUNNYVALE, CA 94088-3409,
Tel. +1 800 234 7381

Uruguay: see South America

Vietnam: see Singapore

Yugoslavia: PHILIPS, Trg N. Pasica 5/v, 11000 BEOGRAD,
Tel. +381 11 625 344, Fax. +381 11 635 777

For all other countries apply to: Philips Semiconductors,
International Marketing & Sales Communications, Building BE-p, P.O. Box 218,
5600 MD EINDHOVEN, The Netherlands, Fax. +31 40 27 24825

Internet: <http://www.semiconductors.philips.com>

© Philips Electronics N.V. 1998

SCA57

All rights are reserved. Reproduction in whole or in part is prohibited without the prior written consent of the copyright owner.

The information presented in this document does not form part of any quotation or contract, is believed to be accurate and reliable and may be changed without notice. No liability will be accepted by the publisher for any consequence of its use. Publication thereof does not convey nor imply any license under patent- or other industrial or intellectual property rights.

Printed in The Netherlands

545102/1200/01/pp48

Date of release: 1998 Mar 24

Document order number: 9397 750 02316

Let's make things better.

**Philips
Semiconductors**



PHILIPS