

Screw terminals
High CV product
Long life 12000 h @ 85°C

RoHS compliant
REACH compliant

Features

- All internal contact welded
- High capacitance
- High CV product
- Long useful life

Applications

- Computer
- Industrial
- Inverter/drives
- Laser

Different case sizes, voltages and capacitance combinations are available on request. Also in small lots.

General specifications

Items		Characteristics
Rated capacitance range C_R		390 ... 3.300.000 μ F
Capacitance tolerance		$\pm 20\%$
Rated voltage range U_R		16 ... 450 V
Surge voltage U_s		$U_R \leq 315$ V: $U_s = 1,15 U_R$ $U_R > 315$ V: $U_s = 1,10 U_R$
Max. reverse voltage / ESL		2 V / 20 nH
Category temperature range		- 40°C ... + 85°C
Leakage current I_L after 5 min @ U_R		$\leq 0,008 * C_R [\mu\text{F}] * U_R [\text{V}] + 6 \mu\text{A} [\mu\text{A}]$
Useful life	12000 h @ 85 °C ; U_R ; I_{R-}	Requirements $\Delta C/C \leq 30$ % of initial value $ESR \leq 300$ % of specified limit $I_L \leq$ specified limit
Endurance test	4000 h @ 85 °C , U_R	Requirements $\Delta C/C \leq 20$ % of initial value $ESR \leq 130$ % of specified limit $I_L \leq$ specified limit
Climatic category IEC 60068		40/085/56
Voltage proof of the external insulation		≥ 2500 V AC
Sectional specification		IEC 60384-4

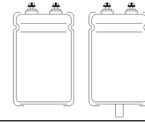

Drawings for series GMXA and GMXB

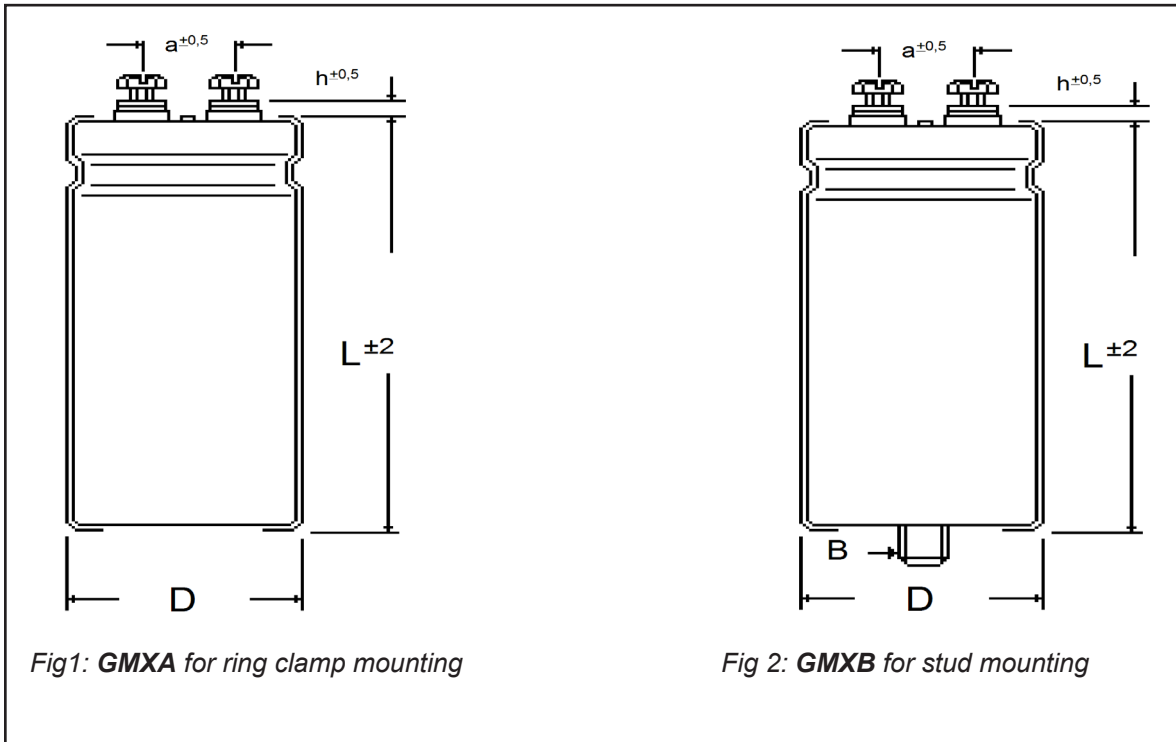

Fig 1: **GMXA** for ring clamp mounting

Fig 2: **GMXB** for stud mounting

Dimensions and mechanical data

Dimensions, case with insulation sleeve				Connecting terminals		Mounting stud, GMXB only	
D	Case length L available in 5 mm	h	a	Thread	Max. torque	B	Max. torque
[mm]	[mm]	[mm]	[mm]		[Nm]		[Nm]
35	40 ... 120	6	13	M 5	2,0	M 8 x 12	4,0
40	40 ... 120	5	18	M 5	2,0	M 8 x 12	4,0
50	40 ... 120	5	22	M 5	2,0	M 12 x 16	10,0
65	40 ... 180	5	28,5	M 5	2,0	M 12 x 16	10,0
75	40 ... 230	5	31,7	M 5, M 6	2,0 ; 2,5	M 12 x 16	10,0
90	40 ... 230	5	31,7	M 6	2,5	M 12 x 16	10,0

	GMXA : connecting screws M 5 or M 6 GMXB : connecting screws M 5 or M 6 + mounting nut M 8 or M 12
Remarks	Further mounting accessories like clamps, nylon cup nuts and insulation disks on request, see "accessory equipment"

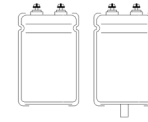

Electrical data and ordering code for series GMX

Rated voltage U_R [V]	Rated cap. C_R [μF]	Case size D x L [mm]	Typ. ESR 100 Hz, 20°C [mΩ]	Ripple current IR~ 100 Hz, 85°C [A]	Order code
					Plain base: GMXA...
					Stud mounting: GMXB...
16	82000	35x55	6	9,0	82301635055
	120000	35x70	4	12,0	12401635070
	120000	40x55	4	11,1	12401640055
	150000	35x80	3	14,2	15401635080
	150000	40x70	3	13,7	15401640070
	180000	35x100	3	17,0	18401635100
	180000	40x80	3	15,8	18401640080
	180000	45x70	3	15,0	18401645070
	220000	40x100	3	19,1	22401640100
	220000	50x70	3	17,7	22401650070
	270000	45x100	3	21,1	27401645100
	270000	50x80	3	20,6	27401650080
	390000	50x100	3	27,0	39401650100
	470000	65x80	3	35,6	47401665080
	560000	65x100	2	42,1	56401665100
	820000	65x130	2	56,5	82401665130
	820000	75x100	1	44,1	82401675100
	1000000	75x115	1	51,3	10501675115
	1200000	75x145	1	61,5	12501675145
	1500000	75x165	1	72,4	15501675165
	1800000	90x148	1	84,8	18501690148
	2200000	75x225	1	99,8	22501675225
	2200000	90x170	1	99,0	22501690170
	2700000	90x220	1	121,7	27501690220
	3300000	90x230	1	137,1	33501690230
	25	22000	35x55	20	4,8
33000		35x70	14	6,5	33302535070
33000		40x55	14	6,1	33302540055
39000		35x80	11	7,5	39302535080
47000		40x70	9	7,9	47302540070
56000		35x100	8	9,8	56302535100
56000		40x80	8	9,1	56302540080
56000		45x70	8	8,6	56302545070
68000		40x100	7	11,0	68302540100
68000		50x70	7	10,2	68302550070
68000		45x100	7	11,0	68302545100
82000		50x80	5	11,7	82302550080
120000		50x100	4	15,5	12402550100
120000		65x80	4	18,3	12402565080
180000		65x100	3	24,3	18402565100
220000		75x100	2	23,2	22402575100
270000		65x130	2	33,0	27402565130
270000		75x115	2	27,1	27402575115
390000		75x145	1	35,7	39402575145
470000		75x165	1	41,2	47402575165
560000		90x148	1	48,1	56402590148
680000		75x225	1	56,5	68402575225

Rated voltage U_R [V]	Rated cap. C_R [μF]	Case size D x L [mm]	Typ. ESR 100 Hz, 20°C [mΩ]	Ripple current IR~ 100 Hz, 85°C [A]	Order code
					Plain base: GMXA...
					Stud mounting: GMXB...
25	680000	90x170	1	56,0	68402590170
	820000	90x220	1	68,2	82402590220
	1000000	90x230	1	76,8	10502590230
40	15000	35x55	25	4,3	15304035055
	18000	40x55	21	4,8	18304040055
	22000	35x70	17	5,7	22304035070
	27000	35x80	14	6,7	27304035080
	27000	40x70	14	6,5	27304040070
	33000	35x100	12	8,1	33304035100
	33000	40x80	12	7,5	33304040080
	33000	45x70	12	7,2	33304045070
	39000	50x70	10	8,3	39304050070
	47000	40x100	8	9,9	47304040100
	47000	50x80	8	9,6	47304050080
	56000	45x100	7	10,7	56304045100
	68000	50x100	6	12,6	68304050100
	82000	65x80	5	16,6	82304065080
	120000	65x100	3	21,8	12404065100
	150000	75x100	3	21,1	15404075100
	150000	65x130	3	27,0	15404065130
	180000	75x115	2	24,3	18404075115
	220000	75x145	2	29,4	22404075145
	270000	75x165	1	34,3	27404075165
	330000	90x148	1	40,6	33404090148
	390000	75x225	1	47,0	39404075225
	390000	90x170	1	46,6	39404090170
	560000	90x220	1	62,0	56404090220
	560000	90x230	1	63,1	56404090230
	63	6800	35x55	42	3,4
8200		40x55	35	3,8	82206340055
10000		35x70	29	4,5	10306335070
12000		35x80	24	5,2	12306335080
12000		40x70	24	5,0	12306340070
15000		35x100	19	6,3	15306335100
15000		40x80	19	5,9	15306340080
15000		45x70	19	5,6	15306345070
18000		50x70	16	6,5	18306350070
18000		40x100	16	7,1	18306340100
22000		50x80	13	7,6	22306350080
22000		45x100	13	7,8	22306345100
27000		50x100	11	9,2	27306350100
39000		65x80	7	13,2	39306365080
47000		65x100	6	15,8	47306365100
68000		75x100	4	16,4	68306375100
68000		65x130	4	21,0	68306365130
82000		75x115	3	19,0	82306375115
100000		75x145	3	22,9	10406375145

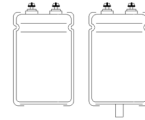

Rated voltage U_R [V]	Rated cap. C_R [μ F]	Case size D x L [mm]	Typ. ESR 100 Hz, 20°C [m Ω]	Ripple current IR~ 100 Hz, 85°C [A]	Order code
					Plain base: GMXA...
					Stud mounting: GMXB...
63	120000	75x165	2	26,4	12406375165
	150000	90x148	2	31,6	15406390148
	180000	75x225	2	36,9	18406375225
	180000	90x170	2	36,6	18406390170
	220000	90x220	1	44,9	22406390220
	270000	90x230	1	50,6	27406390230
80	3900	35x55	82	2,4	39208035055
	5600	35x70	57	3,2	56208035070
	6800	35x80	47	3,7	68208035080
	6800	40x70	47	3,6	68208040070
	8200	40x55	39	3,6	82208040055
	8200	35x100	39	4,4	82208035100
	8200	40x80	39	4,1	82208040080
	10000	45x70	32	4,3	10308045070
	12000	50x70	27	5,1	12308050070
	12000	45x100	27	5,4	12308045100
	15000	40x100	21	6,1	15308040100
	15000	50x80	21	5,9	15308050080
	18000	50x100	18	7,1	18308050100
	22000	65x80	14	9,4	22308065080
	27000	65x100	12	11,3	27308065100
	39000	75x100	8	11,8	39308075100
	39000	65x130	8	15,1	39308065130
	47000	75x115	7	13,6	47308075115
	68000	75x145	5	17,9	68308075145
	68000	75x165	5	18,9	68308075165
100000	90x148	3	24,5	10408090148	
120000	75x225	3	28,6	12408075225	
120000	90x170	3	28,3	12408090170	
150000	90x220	2	35,1	15408090220	
150000	90x230	2	35,8	15408090230	
100	3300	35x55	48	3,1	33210035055
	4700	35x70	34	4,1	47210035070
	4700	40x55	34	3,8	47210040055
	5600	35x80	28	4,7	56210035080
	5600	40x70	28	4,6	56210040070
	6800	35x100	23	5,7	68210035100
	6800	40x80	23	5,3	68210040080
	8200	45x70	19	5,5	82210045070
	10000	50x70	16	6,5	10310050070
	10000	40x100	16	7,1	10310040100
	12000	45x100	13	7,7	12310045100
	12000	50x80	13	7,5	12310050080
	15000	50x100	11	9,2	15310050100
	18000	65x80	9	12,1	18310065080
	22000	65x100	7	14,5	22310065100
	27000	75x100	6	13,9	27310075100
	33000	65x130	5	19,6	33310065130
	39000	75x115	4	17,6	39310075115

Rated voltage U_R [V]	Rated cap. C_R [μ F]	Case size D x L [mm]	Typ. ESR 100 Hz, 20°C [m Ω]	Ripple current IR~ 100 Hz, 85°C [A]	Order code
					Plain base: GMXA...
					Stud mounting: GMXB...
100	47000	75x145	3	21,1	47310075145
	56000	75x165	3	24,2	56310075165
	68000	90x148	2	28,6	68310090148
	82000	75x225	2	33,4	82310075225
	82000	90x170	2	33,1	82310090170
	120000	90x220	1	44,5	12410090220
	120000	90x230	1	45,3	12410090230
	160	1800	35x55	62	2,8
2200		35x70	51	3,4	22216035070
2200		40x55	51	3,1	22216040055
2700		35x80	41	3,9	27216035080
2700		40x70	41	3,8	27216040070
3900		35x100	29	5,2	39216035100
3900		40x80	29	4,8	39216040080
3900		45x70	29	4,6	39216045070
4700		50x70	24	5,4	47216050070
4700		40x100	24	5,8	47216040100
5600		45x100	20	6,3	56216045100
5600		50x80	20	6,1	56216050080
6800		50x100	16	7,4	68216050100
8200		65x80	14	9,7	82216065080
12000		65x100	9	12,8	12316065100
15000		75x100	7	12,4	15316075100
18000		65x130	6	17,3	18316065130
18000		75x115	6	14,3	18316075115
27000		75x145	4	19,1	27316075145
27000		75x165	4	20,1	27316075165
39000	75x225	3	27,5	39316075225	
39000	90x148	3	25,9	39316090148	
47000	90x170	2	30,0	47316090170	
56000	90x220	2	36,3	56316090220	
56000	90x230	2	37,0	56316090230	
250	1000	35x55	96	2,2	10225035055
	1500	35x70	64	3,0	15225035070
	1500	40x55	64	2,8	15225040055
	1800	35x80	53	3,5	18225035080
	1800	40x70	53	3,3	18225040070
	2200	35x100	43	4,2	22225035100
	2200	40x80	43	3,9	22225040080
	2200	45x70	43	3,7	22225045070
	2700	50x70	35	4,4	27225050070
	3300	40x100	29	5,2	33225040100
	3900	45x100	24	5,7	39225045100
	3900	50x80	24	5,5	39225050080
	4700	50x100	20	6,6	47225050100
	5600	65x80	17	8,7	56225065080
	8200	65x100	12	11,4	82225065100
	10000	75x100	10	10,9	10325075100
	12000	65x130	8	15,3	12325065130

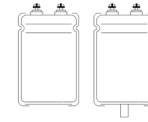

Rated voltage U_R [V]	Rated cap. C_R [μ F]	Case size D x L [mm]	Typ. ESR 100 Hz, 20°C [m Ω]	Ripple current IR~ 100 Hz, 85°C [A]	Order code
					Plain base: GMXA...
					Stud mounting: GMXB...
250	12000	75x115	8	12,6	12325075115
	18000	75x145	5	16,8	18325075145
	18000	75x165	5	17,7	18325075165
	27000	75x225	4	24,7	27325075225
	27000	90x148	4	23,2	27325090148
	27000	90x170	4	24,5	27325090170
	39000	90x220	2	32,7	39325090220
	39000	90x230	2	33,3	39325090230
350	560	35x55	171	1,7	56135035055
	680	40x55	141	1,9	68135040055
	820	35x70	117	2,2	82135035070
	1000	35x80	96	2,6	10235035080
	1200	40x70	80	2,7	12235040070
	1200	45x70	80	2,7	12235045070
	1500	35x100	64	3,5	15235035100
	1500	40x80	64	3,2	15235040080
	1800	50x70	53	3,6	18235050070
	1800	40x100	53	3,9	18235040100
	1800	50x80	53	3,8	18235050080
	2200	45x100	43	4,3	22235045100
	2700	50x100	35	5,0	27235050100
	3300	65x80	29	6,7	33235065080
	3900	65x100	24	7,9	39235065100
	4700	75x100	20	7,5	47235075100
	5600	65x130	17	10,4	56235065130
	5600	75x115	17	8,6	56235075115
	8200	75x145	12	11,4	82235075145
	8200	75x165	12	12,0	82235075165
	12000	75x225	8	16,5	12335075225
	12000	90x148	8	15,5	12335090148
	15000	90x170	6	18,3	15335090170
	18000	90x220	5	22,2	18335090220
18000	90x230	5	22,6	18335090230	
400	390	35x55	327	1,2	39140035055
	560	35x70	227	1,6	56140035070
	560	40x55	227	1,5	56140040055
	680	35x80	187	1,8	68140035080
	820	40x70	155	2,0	82140040070
	820	40x80	155	2,1	82140040080
	1000	35x100	127	2,5	10240035100
	1000	45x70	127	2,2	10240045070
	1200	50x70	106	2,5	12240050070
	1200	40x100	106	2,7	12240040100

Rated voltage U_R [V]	Rated cap. C_R [μ F]	Case size D x L [mm]	Typ. ESR 100 Hz, 20°C [m Ω]	Ripple current IR~ 100 Hz, 85°C [A]	Order code
					Plain base: GMXA...
					Stud mounting: GMXB...
400	1500	45x100	85	3,0	15240045100
	1500	50x80	85	3,0	15240050080
	1800	50x100	71	3,6	18240050100
	2200	65x80	58	4,7	22240065080
	2700	65x100	47	5,7	27240065100
	3300	65x100	40	5,8	33240065100
	3900	75x100	33	5,9	39240075100
	3900	65x130	33	7,5	39240065130
	4700	75x115	27	6,8	47240075115
	6800	75x145	19	9,0	68240075145
	6800	75x165	19	9,4	68240075165
	10000	90x148	13	12,2	10340090148
	12000	75x225	11	14,3	12340075225
	12000	90x170	11	14,2	12340090170
	15000	90x220	8	17,6	15340090220
	18000	90x230	7	19,6	18340090230
450	390	35x55	286	1,3	39145035055
	470	35x70	237	1,6	47145035070
	560	35x80	199	1,8	56145035080
	560	35x100	199	2,0	56145035100
	680	40x55	164	1,7	68145040055
	820	40x70	136	2,1	82145040070
	820	40x80	136	2,2	82145040080
	1000	45x70	111	2,3	10245045070
	1000	40x100	111	2,7	10245040100
	1200	50x70	93	2,7	12245050070
	1200	45x100	93	2,9	12245045100
	1200	50x80	93	2,8	12245050080
	1800	50x100	62	3,8	18245050100
	1800	65x80	62	4,6	18245065080
	2700	65x100	41	6,1	27245065100
	3300	65x130	34	7,4	33245065130
	3900	75x100	29	6,3	39245075100
	3900	75x115	29	6,6	39245075115
	4700	75x145	26	7,6	47245075145
	5600	75x145	20	8,7	56245075145
	6800	75x165	16	10,1	68245075165
	8200	75x225	14	12,6	82245075225
	10000	90x148	11	13,1	10345090148
	10000	90x170	11	13,8	10345090170
15000	90x220	7	18,8	15345090220	
15000	90x230	7	19,1	15345090230	
12000	90x220	7	17,9	12345090220	

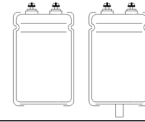

Useful life
as a function of ambient temperature and actual ripple current

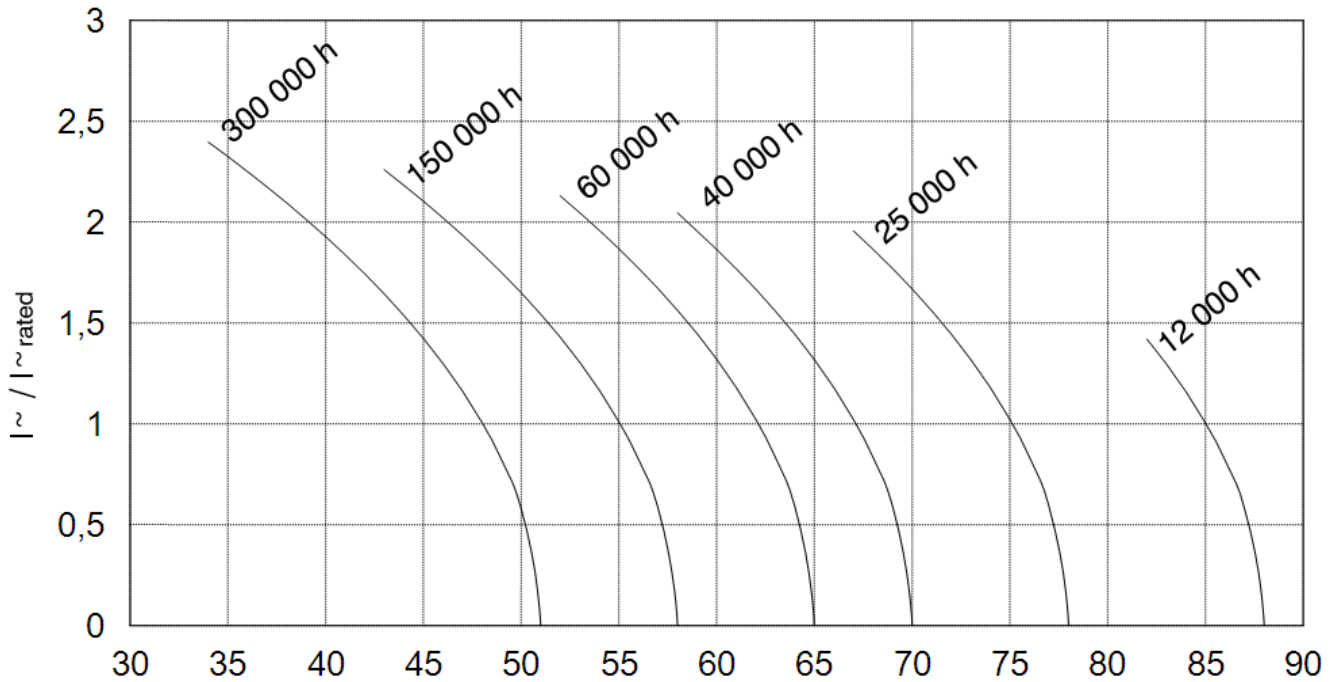

Ripple current and ESR
As a function of frequency f

