

**COMMUNICATIONS**

**RS232**

The RS232 port can be used to communicate with one module at a time. No more than one module must be connected to an RS232 port at any one time. To connect the C 120 to a host RS232 port, follow the diagram below.

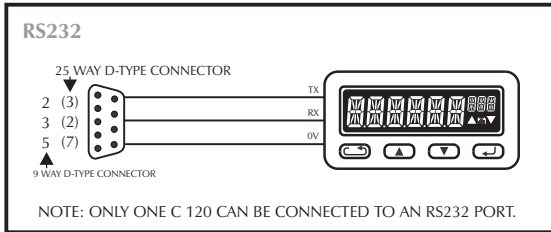

**RS485**

Multiple modules may be connected to the RS485 port at any one time. The RS485 port can be used to communicate with one module at a time. Ensure that all C 120 modules have different addresses but the same Baud rate. To connect the C 120 to a host RS485 port, follow the diagram below.

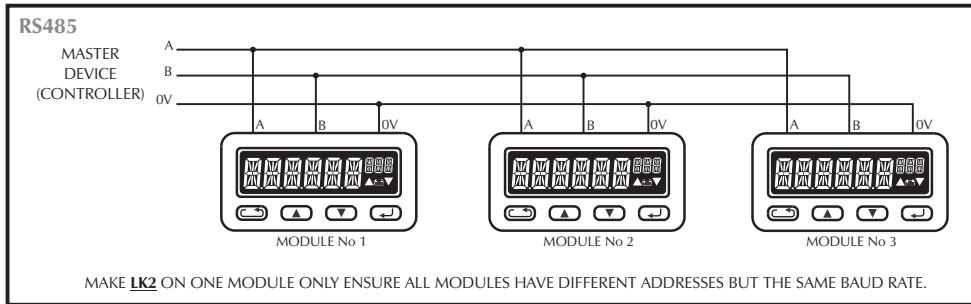

**INFRARED**

To add InfraRed communications capability to C 120, connect it to a PANEL-IR module. The InfraRed port can be used to communicate with one module at a time. Multiple modules may be connected to the InfraRed port at any one time. To connect the C 120 to a Lascar PANEL-IR, follow the diagram below

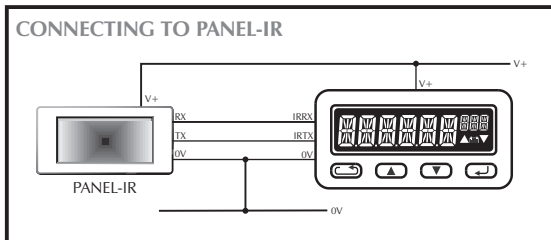

LASCAR ELECTRONICS LTD.  
 MODULE HOUSE, WHITEPARISH, WILTSHIRE SP5 2SJ UK  
 TEL: + +44 (1794) 884567 FAX: + +44 (1794) 884616  
 E-mail: sales@lascar.co.uk

LASCAR ELECTRONICS INC.  
 3750 West 26th Street, Erie, PA 16506 USA  
 TEL: +1 (814) 835 0621 FAX: +1 (814) 838 8141  
 E-mail: us-sales@lascarelectronics.com

LASCAR ELECTRONICS (HK) LIMITED  
 FLAT C, 5/F., LUCKY FTY. bldg., 63-65 HUNG TO ROAD  
 KWUN TONG, KOWLOON, HONG KONG  
 TEL: +852 2797 3219 FAX: +852 2343 6187  
 E-mail: b4lascar@samsongroup.com.hk

[www.lascarelectronics.com](http://www.lascarelectronics.com)

C 120 is the third module in a family of programmable LCD counter modules. This microcontroller-based module is designed round a 6+3 character alphanumeric starburst LCD. The LED backlit display shows the 6 digit counter readings as well as a comprehensive operator menu. Navigation through the menu, using the front keypad, is straightforward and allows the user to select the desired timer range. Besides displaying time, the module can be made to control external events via its two open collector outputs.

C 120 can communicate with other intelligent systems via its built-in RS232 and RS485 communication ports. This module is compatible with Lascar's InfraRed communications products, such as PANEL-IR. To make assembly easy, the meter is housed in a snap-in DIN-sized enclosure.

- 12H/24H/24H+ Day Timer
- Password Protection
- 2 Alarm Outputs
- Modules can be Networked
- Remembers Settings
- LED Backlit LCD



Standard Meter	Stock Number C 120			Unit
Specification	Min.	Typ.	Max.	
Supply voltage	4.5	5	5.5	V d.c.
Supply current (Backlighting on)		40		mA
Supply current (Backlighting off)		25		mA
Input voltage			15	V d.c.
Timer range (12hour clock, AM/PM)	12:00:00 <sup>min</sup>		11:59:59 <sup>max</sup>	hh:mm:ss
Timer range (24 hour clock)	00:00:00		23:59:59	hh:mm:ss
Timer range (24 hour clock & No. of days)	00:00:00		23:59:59 <sup>max</sup>	hh:mm:ss <sup>max</sup>
Resolution		1		sec
Operating temperature range	0		50	°C

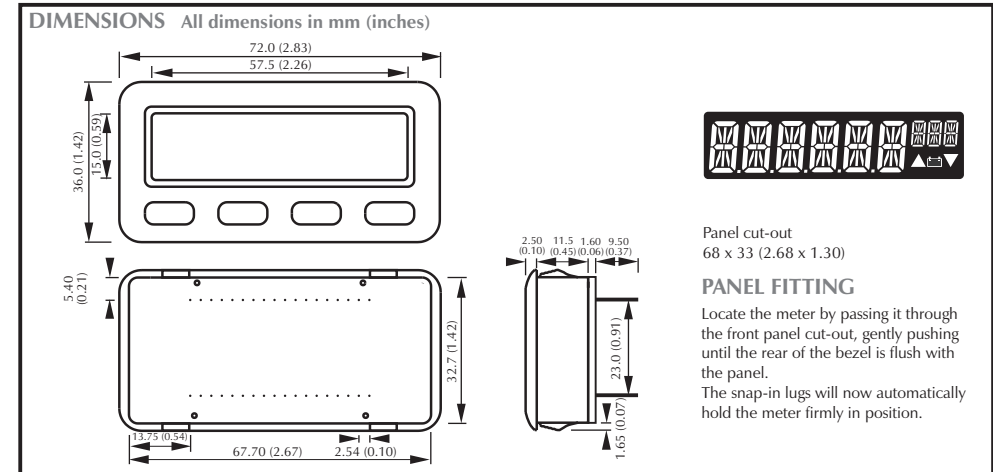

**PIN FUNCTIONS**

V+	Positive supply voltage.
0V	Negative supply voltage.
COUNT IN	Not connected.
0V	Not connected.
LAP IN	When taken High, the last displayed reading is held indefinitely. The internal timer continues. When left floating or taken Low, the display is normally updated.
STRT/STP	Starts the timer when taken High. Stops the timer when taken Low.
RES IN	Resets the display to the preset value (timing Down) or to zero (timing Up).
UP-DN	Not connected. Use Menu to select direction of timing.
HIGH	Not connected.
LOW	Not connected.
232 TX	RS232 communications port (transmit line).
232 RX	RS232 communications port (receive line).
0V	Ground for the RS232 and RS485 communications ports.
485A	RS485 communications port.
485B	RS485 communications port.
RESET	Take Low to reset the module.*
IR RXD	InfraRed Receive connection.
IR TXD	InfraRed Transmit connection.
0V	Ground for InfraRed communications section.
NC5	Not connected.
NC4	Not connected.
NC3	Not connected.
NC2	Not connected.
NC1	Not connected.
ZERO	Zero output. Open collector output, capable of sinking up to 50mA. Goes Low when the reading is equal to zero. In hh:mm:ss:ddd mode, the day must be 0. In 12-hour mode, the time must be 12:00:00AM.
=	Equals output. Open collector output, capable of sinking up to 50mA. Goes High when the reading equals the preset value.
C/O	Not connected.
NC0	Not connected.
SW4	External switch input. Take Low to mimic the front panel ESC button.
SW3	External switch input. Take Low to mimic the front panel UP button.
SW2	External switch input. Take Low to mimic the front panel DOWN button.
SW1	External switch input. Take Low to mimic the front panel ENTER button.

Low = 0V  
High = +5V

\* When reset is taken Low, all the module's settings are reset to the last *saved* settings, otherwise the default values are used.

**APPLICATIONS**

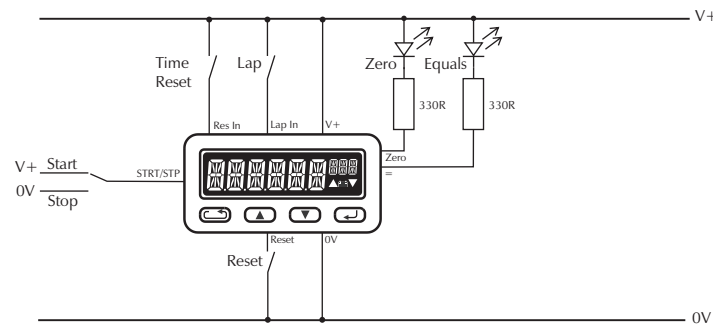

Evaluation Circuit showing use of C120 inputs and outputs.

**RELAY**

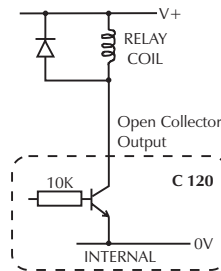

Using an Open Collector Output to drive a relay.

**TRIAC**

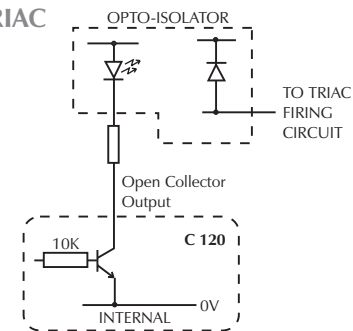

Using an Open Collector Output to drive a Triac.

**IMPORTANT SAFETY INFORMATION**

To comply with the Low Voltage Directive (LVD 93/68/EEC), input voltages to the module's pins must not exceed 60Vdc. If voltages to the measuring inputs do exceed 60Vdc, then fit scaling resistors externally to the module. The user must ensure that the incorporation of the C 120 into the user's equipment conforms to the relevant sections of BS EN 61010 (Safety Requirements for Electrical Equipment for Measuring, Control and Laboratory Use).

## DISPLAY INDICATORS

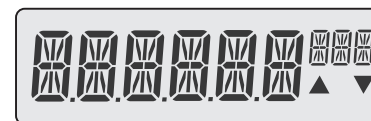

### 6 Large Starburst Digits

- In Normal Mode, the 6 Large Starburst Digits are used to display time.
- In Menu Mode, the 6 Large Starburst Digits are used to display the menu options.

### 3 Small Starburst Digits

- In Normal Mode, the 3 Small Starburst Digits are used to display AM/PM (12 Hour mode) or Days (24 Hour + Day mode)
- In Menu Mode, the 3 Small Starburst Digits are used to display some of the menu options.

### Up Arrow

- In Menu Mode, the Up Arrow indicates that one or more menu options are available by pressing the Up Arrow button.

### Down Arrow

- In Menu Mode, the Down Arrow indicates that one or more menu options are available by pressing the Down Arrow button.

## FRONT KEYPAD FUNCTIONS

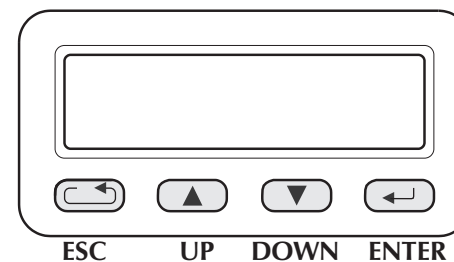

### In NORMAL MODE

- ESC : Toggles LED backlighting on and off.
- ENTER : Enters operator menu at password level.

### In MENU MODE

- ESC : Escapes the operator to the previous menu level or progresses to the next digit when entering values.
- UP : Scrolls upwards through the available options until the end of the options list has been reached. Only available if the Up Arrow is shown on the LCD.
- DOWN : Scrolls downwards through the available options until the end of the options list has been reached. Only available if the Down Arrow is shown on the LCD.
- ENTER : Toggles between available options or selects current option, depending on location in menu.

## THE MENU MAP

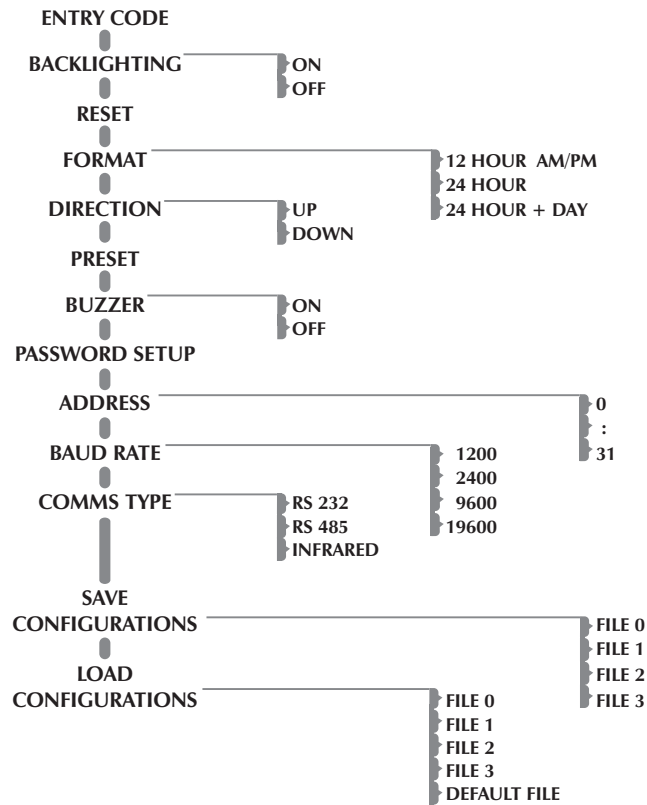

The module will remember the current configuration settings for as long as the module receives a correct supply voltage. When power is removed (or reduced below the “correct” supply voltage) and re-applied, all settings are lost, and the module powers up to the last saved settings. If none were saved, the module powers up to the factory default settings. To avoid losing your settings, save them in one of four “File” locations. See Saving on page SW5 for details on how to save configuration settings.

## SERIAL PROTOCOL

## Additional Command Details

## “ALL”

Sends data about the setup of the meter to the master unit. The following data is sent.

```

FIRMWARE VERSION
TIME FORMAT      (0=12hr, 1=24hr, 2=24hr+day)
UP/DOWN          (0=Down, 1=Up)
PRESET VALUE     (hh mm ss ddd)
BACKLIGHT ON/OFF
BUZZER ON/OFF
  
```

## Notes:

Do not try to link up more than one module to a RS232 serial bus as it is only designed for two devices (transmitter & receiver).

RS232 and RS485 communications require 8 Data Bits, 1 Stop Bit and No Parity.

All serial communications must be started with an address aa, the default value of which is “00”. Two or more modules sharing the same RS485 serial bus cannot have the same address or all will try to reply at once, giving an error condition. If the address of the module is not known, then use \*\* <command>, where \*\* is used as an ‘any meter reply’ command. To avoid device conflict when using this command, only one counter should be attached to an RS485 serial bus at any one time.

All commands must be followed by a CRLF (Carriage Return & Line Feed). The serial port has a certain amount of memory allocated which will loop around if too many characters are sent, therefore protecting against bad data.

A response of ‘1’ shows that the module has responded.

A response of ‘0’ usually shows that an illegal value has been input by the user, although a counter was attached at that address.

No response indicates that no meters are connected to that address.

## SERIAL PROTOCOL

All commands are case-sensitive and must be preceded by a two digit address *aa*, corresponding to the meter's address. The default address is 00.

DESCRIPTION	ADDRESS	COMMAND	RESPONSE
<b>COMMUNICATIONS</b>			
NEW BAUD RATE (1200BPS)	aa	B0	1
NEW BAUD RATE (2400BPS)	aa	B1	1
NEW BAUD RATE (9600BPS)	aa	B2	1
NEW BAUD RATE (19200BPS)	aa	B3	1
NEW ADDRESS (00 - 31)	aa	Nxx	1
COMMS SELECTION (RS232)	aa	I0	1
COMMS SELECTION (RS485)	aa	I1	1
COMMS SELECTION (INFRARED)	aa	I2	1
(The response will be in the newly selected mode.)			
<b>GENERAL</b>			
HELLO ? (Any meters attached?)	aa	R	1
READ MODULE SERIAL NUMBER	aa	F0	SER NO
BACKLIGHTING OFF	aa	G0	1
BACKLIGHTING ON	aa	G1	1
BUZZER ON	aa	Q1	1
BUZZER OFF	aa	Q0	1
CURRENT TIME	aa	V	LCD TIME
"ALL"	aa	X	INFO (See next page for details.)
SET ANNUNCIATORS	aa	Exxxx	1
LOAD DEFAULT SETUP	aa	UD	1
LOAD SETUP FROM FILE n	aa	Uln (n=0 - 3)	1
SAVE EXISTING SETUP TO FILE n	aa	Usn (n=0 - 3)	1
SET DIRECTION	aa	TUn (0=down, 1=up)	1
SET FORMAT	aa	TF (0=12Hr, 1=24Hr, 2=24Hr+Day)	1
SET PRESET TIME	aa	TTHHMMSS	1
SET PRESET DAY	aa	TDxxx (000 - 999)	1

## THE OPERATOR MENU

The user can configure the C120 via the 4 push buttons on the front of the module. Alternatively, use the SW1 to SW4 pins on the rear.

## MENU FUNCTIONS

Press ENTER, then enter the passcode. UP and DOWN change the digit to the required code. ESC progresses to the next digit. Press ENTER on the correct code to gain access to the configuration menu. The default code is 0000.

### LCD Backlighting : BACK L

This module features LED Backlighting to illuminate the LCD under low light conditions.

- Default state: ON.
- Pressing ENTER will toggle the backlighting ON/OFF (when saved, this determines the condition on power up)
- Note: in Normal Mode, ESC toggles the backlighting ON/OFF. While ESC is pressed, the reading is held, but the internal timer continues.

### Reset Timer: TIMER<sup>RST</sup>

The timer can be reset to zero (timing Up) or to the preset value (timing Down).

- Default state: No Reset.
- Pressing ENTER will reset the timer.

### Time Format: FORMAT

The Time Format can be changed to accommodate 12 hour or 24 hour timing, the latter with optional day counting.

- Default state: 24 HOUR
- Press ENTER to change the Time Format.
- UP and DOWN change the Time Format between 12 HOUR AM/PM, 24 HOUR and 24 HOUR + DAY.
- Pressing ENTER accepts the required Time Format.

### Timing Direction: DIRECT

The Timing Direction can be changed to accommodate up and down timing. When timing down, the timer will stop at 12:00:00AM / 00:00:00, depending on the timer mode.

- Default state: UP
- Pressing ENTER toggles the Timing Direction UP/DOWN.

### Presetting the Counter: PRESET

The timer can be preset with a value, the range of which depends on the FORMAT setting. When timing up, the timer will stop when it reaches the preset value. If the preset value is equal to 12:00:00AM / 00:00:00, then the timer will count uninterrupted. After changing the preset value, it is recommended to reset the timer, to ensure the time is within the start and finish points.

12 HOUR AM/PM	: Any time, AM or PM	Default value: 12:00:00 AM
24 HOUR	: Any Time	Default value: 00:00:00
24 HOUR + DAY	: Any Time + a day in the range 0 to 999	Default value: 00:00:00 <sup>0</sup>

- Press ENTER to select a new Preset value. UP and DOWN change the digits to the required value. ESC progresses to the next digit.
- Pressing ENTER accepts the new Preset value.

### Audible Feedback: BUZZER

The module features a buzzer which emits a tone when a key is pressed or when the Equals level has been reached.

- Default state: OFF
- Pressing ENTER toggles the buzzer ON/OFF. The effect of the Zero and Equals levels on the buzzer is immediate.

**Passcode Protection: CODE**

The module incorporates a four digit Passcode facility. This security feature allows a system administrator to ensure that the configurations set up via this menu cannot be changed, either by accident or malice.

- Default value: 0000
- Press ENTER to select a new Passcode. The display reads 0000.  
UP and DOWN change the digits to the required code. ESC progresses to the next digit.
- Pressing ENTER accepts the new Passcode.

**DO NOT FORGET YOUR PASSCODE AS WITHOUT IT, YOU CANNOT ENTER THE MENU SYSTEM.**

**Module Address: ADDR**

Each module in a networked system can be assigned its own unique address, ranging from 0 to 31 inclusive.

- Default address: 00
- Press ENTER to activate Address selection.  
UP and DOWN select the required module Address.
- Pressing ENTER accepts the new Address.

Note: To avoid communication conflicts in a networked system, no two modules must share the same address.

**Baud Rate: BAUD**

Select an appropriate Baud rate to communicate with the module over an RS232, RS485 or InfraRed link.

- Default value: 9600
- Press ENTER to activate Baud rate selection.  
UP and DOWN select the required Baud rate from 1200, 2400, 9600 and 19200 Baud.
- Pressing ENTER accepts the new Baud Rate.

**Communications: COMMS**

Select an appropriate communications link.

- Default state: RS232
- Press ENTER to activate Comms selection.  
UP and DOWN select between RS232 (232), RS485 (485) and InfraRed (IR).
- Pressing ENTER accepts the new Communications Link.

**Configuration File Loading: LOAD**

Load a configuration file from memory.

- Default file: Default file.
- Press ENTER to activate File selection.  
UP and DOWN select from Files 0, 1, 2, 3 or Default
- Pressing ENTER accepts the new Configuration File.

**Configuration File Saving: SAVE**

Save configuration settings to one of 4 memory files. This allows different set-ups to be easily Loaded from file without the need to set up a complete menu's worth of configurations.

- Default file: File 0.
- Press ENTER to activate File selection.  
UP and DOWN select from Files 0, 1, 2, 3 or Default.
- Pressing ENTER accepts the new Save file.