

# DMM 939

3<sup>3</sup>/<sub>4</sub> Digit LCD Autoranging Multimeter

This module is a complete multimeter in a panel instrument. It is especially useful in portable equipment and has 12 ranges:

D.C. - 400mV, 4V, 40V and 400V (Maximum IP  $\pm 375V$ )

D.C. - 4000 $\mu$ A, 40mA, 400mA, 4A,

Resistance - 4k $\Omega$ , 40k $\Omega$ , 400k $\Omega$  and 4M $\Omega$ .

- 🔊 15mm (0.6") Digit Height
- 🔊 Digital Hold
- 🔊 Autoranging
- 🔊 Low Battery Indication
- 🔊 LED Backlighting
- 🔊 D.C. Supply Isolator
- 🔊 Continuity Beeper Output

## METER PROTECTION

The meter should be protected against accidental application of high voltages on ohms and current ranges by a fast-blow 5A fuse.

## RECALIBRATING THE METER

Power the meter with its typical working voltage and make connections as follows:

- Connect Pin 8 to Pin 1.
- Apply -3.700 volts D.C. between V/ $\Omega$  (Pin 3) and COM (Pin 4).
- Adjust R4 until meter displays -3.700V.

## LOW POWER OPERATION

If ultra low power operation is required, then an isolated supply (battery) can be applied across V+ and V- to give this mode of operation.

Note - Ensure that the supply does not exceed 11 volts.

Low Power Operation	Min.	Typ.	Max.	Unit
Supply voltage (V+ to V-)	7	9	11	V
Supply current		1.5	2.4	mA
Low battery threshold	6.5	7	7.5	V



Stock Number				DMM 939
Standard Meter				
Specification	Min.	Typ.	Max.	Unit
Accuracy	D.C. volts 400V		$\pm 2$	% Rdg $\pm 1$ count
	D.C. volts all other		$\pm 0.3$	% Rdg $\pm 1$ count
	Ohms 4 kilohms, 400 kilohms		$\pm 0.75$	% Rdg $\pm 8$ counts
	Ohms 40 kilohms, 4 megohms		$\pm 1$	% Rdg $\pm 9$ counts
	D.C. current adjusted		$\pm 0.5$	% Rdg $\pm 2$ counts
Linearity (best straight line)	-1		+1	count
Rollover error		$\pm 4$		counts
Operating temperature range	0		50	$^{\circ}C$
Supply voltage (Vp+ to Vp-)	5	9	18	V
Supply current (excluding backlight)	5	7	13	mA
Continuity detect low ohm range		1.5		kilohms
Converter isolation (D.C.)			40	V
Backlight current (5V nom.)		50	90	mA

## CONNECTOR SOURCING GUIDE

METHOD	Cable Mounting IDC Supplied With Product
--------	--

## DIMENSIONS All dimensions in mm (inches)

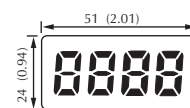
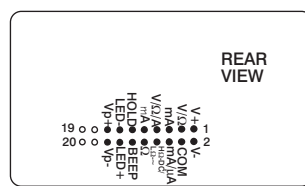
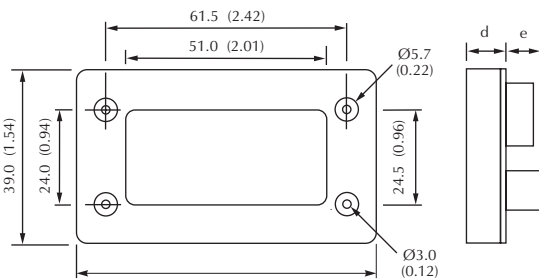

- a. 1.0 (0.04)
- b. 2.0 (0.08)
- c. 6.5 (0.26)
- d. 11.5 (0.45)
- e. 10.0 (0.39)



**OVERLOAD**  
When the meter displays "OL" this indicates that the meter inputs have been taken beyond their working range.

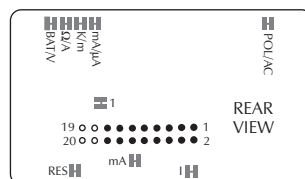
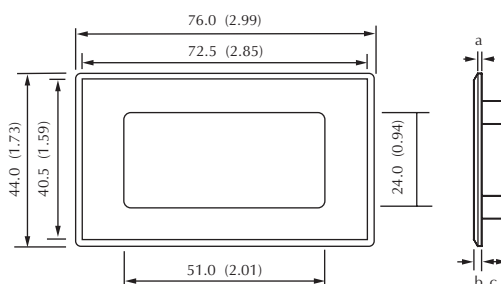

■ ON BOARD SOLDER LINKS

## PIN FUNCTIONS

- |                 |  |   |
|-----------------|--|---|
| 1. V+           | Positive power supply connection. Not isolated.  | } Pins 1 and 2 are used for mode selection and low power operation. |
| 2. V-           | Negative power supply connection.  |   |
| 3. V/Ω          | Positive Volts measuring input. Connect to Ω (Pin 10) to measure resistance.   |   |
| 4. COM          | Ground for analogue section of the A/D converter, it is held actively at 2.9V (typ.) below V+. COM must not be allowed to sink excessive current (>100µA) by connecting it directly to a higher voltage.   |   |
| 5. mA           | Positive milli-Amperes measuring input.  |   |
| 6. mA/µA        | Tri-state input, connect to V+ to display 'mA' annunciator. Connect to COM to display 'µA' annunciator. Note - mA/µA annunciators will not be displayed unless Pin 7 is connected to V-.   |   |
| 7. V/Ω/A        | Tri-state input, connect to COM to operate voltage range and to display 'V' annunciator. Connect to V+ to operate Resistance range and to display relevant 'Ω' annunciator or connect to V- to display either mA or µA, selection between each of these annunciators is determined by Pin 6. |   |
| 8. HΩ-DC/<br>LΩ | Tri-state input, connect to V+ to select High Ohms and D.C. range input. Connect to COM for Low Ohms. All the ranges will show the appropriate annunciator, MΩ, kΩ or ~ symbol.  |   |
| 9. µA           | Positive micro-Amperes measuring input.  |   |
| 10. Ω           | Ohms measuring input. Connect to Pin 3 when measuring resistance.  |   |
| 11. HOLD        | Tri-state input, connect to V+ to hold display reading.  |   |
| 12. BEEP        | The continuity beeper output is designed to drive a piezo-electric transducer at approximately 2KHz with a voltage swing of V+ to V-. Note - The beeper output off state is at the V+ rail.  |   |
| 13. LED-        | Negative supply to LEDs for backlighting.  | } LED+ to LED- supply voltage of 5V.                                |
| 14. LED+        | Positive supply to LEDs for backlighting.  |   |
| 15. Vp+         | Positive isolated power supply connection.   | } It is recommended that the meter is powered using these pins.     |
| 16. Vp-         | Negative isolated power supply connection.   |   |
| 17-20           | No pins fitted.  |   |

Tri-State Input Connections			
Pin No.	V+	OPEN or COM	V-
6	mA	mA	Do not connect to V-
7	Ω	V	A
8	HΩ-DC	LΩ	Do not connect to V-
11	HOLD	AUTO	Do not connect to V-

## VARIOUS OPERATING MODES

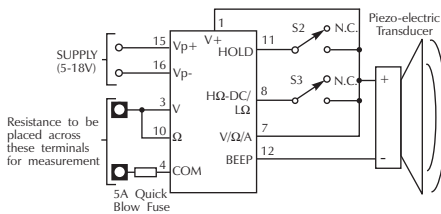

### Autoranging Resistance Meter

Ranges: Low Ohm - 4kΩ, 40kΩ  
 High Ohm - 400kΩ, 4MΩ

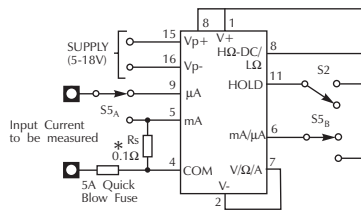

### Autoranging D.C. Current Meter

Ranges: µA - 4000µA, 40mA  
 mA - 400mA, 4000mA

\*Note - Rs is the current sensing resistor and must be capable of handling as a minimum the full scale current of 4 amps. To allow for overload conditions, it is recommended that a 6W, 0.5% resistor is fitted. It must be fitted when EITHER of the current ranges are being used.

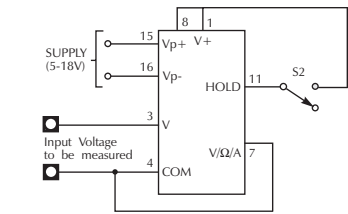

### Autoranging Volt Meter

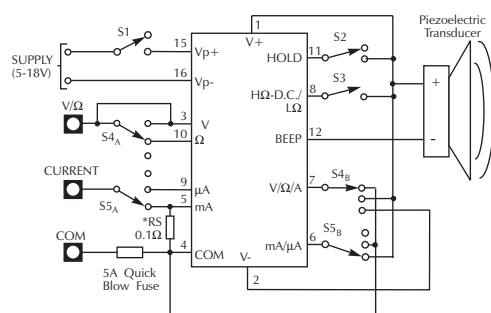

### Autoranging Voltage, Current and Resistance Meter

\*See note on Current Meter diagram.

## SWITCHES

- S1. Switch 1 is an on/off switch.
- S2. Switch 2 is used to hold the display reading.
- S3. In Voltage mode, switch 3 is used to select D.C. measurement and the ~ symbol. In Resistance mode, this switch is used to select either high or low ohms ranges.
- S4. Switch 4 selects either the Voltage, Current or Resistance ranges.
- S5. Switch 5 selects between Current ranges.

## HEALTH AND SAFETY

1. When the DMM is used for current or resistance measurements, an external fuse MUST be fitted.
2. When measuring voltages in excess of 60V peak, the system within which the DMM is incorporated, should conform to relevant sections of IEC 1010 (Safety Requirements for Electrical Equipment for Measuring, Control and Laboratory Use).
3. If this product is to be used for measuring mains supply voltages, external transient protection should be adopted.
4. To comply with the Low Voltage Directive (LVD 93/68/EEC), input voltages to the module's pins must not exceed 60Vdc, then fit scaling resistors externally to the module. The user must ensure that the incorporation of the DPM into the user's equipment conforms to the relevant sections of BS EN 61010 (Safety Requirements for Electrical Equipment for Measuring, Control and Laboratory Use).