

EasyLog[®] EL-3-12BIT

WINDOWS[™] Compatible Data Logger

EL-3-12BIT is an easy to use dual channel data logging display module capable of measuring, recording, displaying and controlling temperature (Pt 100), voltage and current. Each channel features 12 bit A/D resolution, and a memory for 8000 readings. EL-3-12BIT can operate as a 'stand alone' logger or be permanently connected to a system. The EL-3-12BIT serial link is addressable and up to 8 loggers can be connected to one serial port. The PC software operates under Windows and does not require specialist skill to operate. Data output is in graph or text format and can be easily integrated into most popular spreadsheets. Graphical output is possible under EL-WIN. Consult the EasyLog software manual for further details.

- ☪ Battery Powered
- ☪ Multi-function
- ☪ Non-volatile Data Storage
- ☪ Panel Mounting
- ☪ Dual Channel
- ☪ High Resolution Read-out

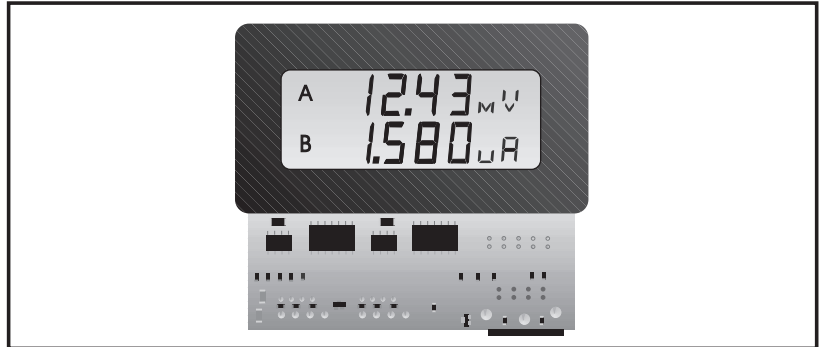

CONTROL SOFTWARE

Stock Number - EL-WIN (version 4.04 or later)

Easy to install and use, the control software will run under Windows 98, 95 or 3.1 and enable the user to control one or more EasyLogs, operating them as a complete system. Supplied on a 3 1/2" disk with a manual and serial link.

ACCESSORIES - CABLES

Stock Number - EasyLink

Extension cable to 'daisy chain' more than one EasyLog. One extension will be needed for each extra EL-3-12BIT module that is attached to the chain.

SENSOR SOURCING GUIDE

Sensor	Stock Number
Temperature (Pt100)	PT-TYPE PROBE
Humidity (%RH)	RH PROBE

Dual Channel Data Logger			Stock Number
			EL-3-12BIT
Specification (each channel)	Range	Resolution	Accuracy
Temperature - Low Range *	-200 to +200°C	0.1°C	±0.5°C
	-200 to +200 °F	0.1°F	±1°F
Temperature - High Range *	-200 to +850°C	1°C	±1°C
	-328°F to +1562°F	1°F	±2°F
Voltage - d.c.	0 to ±200mV	100µV	±0.05% ±1 Count
	0 to ±2V	1mV	
	0 to ±20V	10mV	
Current - d.c.	4 to 20mA	16µA	±0.1% ±1 Count
Battery	3.6V 1/2AA lithium		
Serial link	8 Pin Mini DIN		
Sensor connection	Screw terminal		
Memory	Up to 8000 samples per channel		
Sample rate	1 sample per 5 seconds to 1 per 12 hours.		

* Sensor dependent

Input Impedance	200mV Range	>1GΩ
	2V, 20V Range	0.5MΩ
	4-20mA Range	10Ω

DIMENSIONS All dimensions in mm (inches)

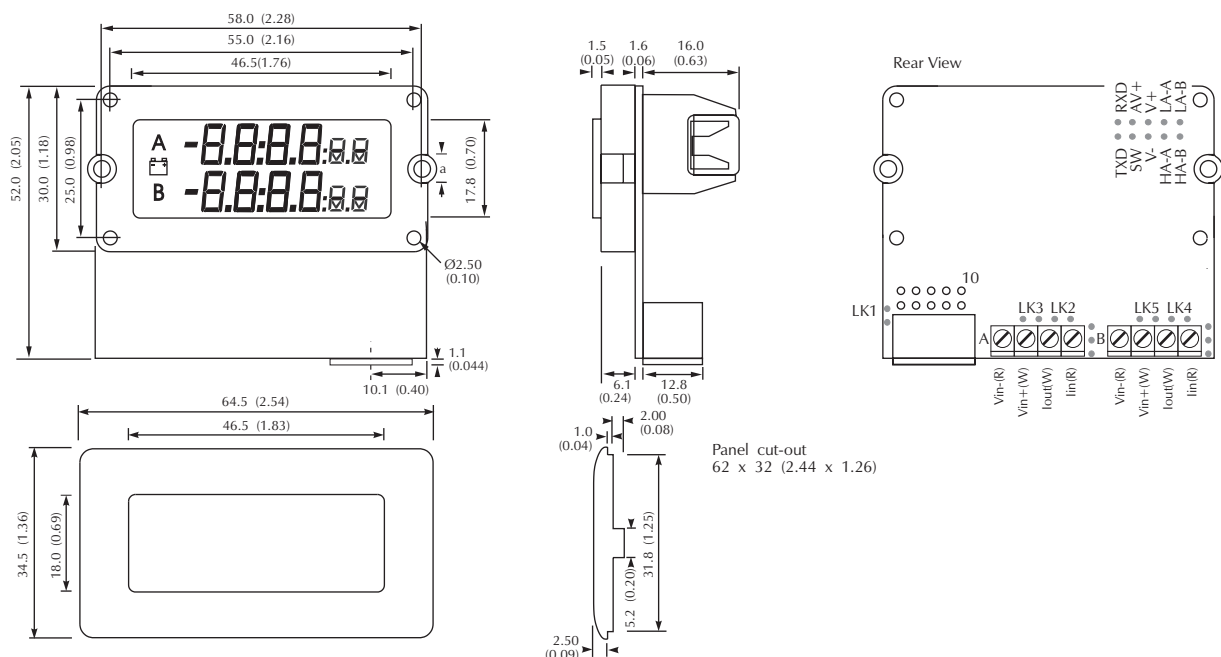

WEBSITE: <http://www.lascarelectronics.com/>

LINK FUNCTIONS

Lk1: When daisy-chaining EasyLog Modules, remove the Lk1 jumpers from all modules except one.
 Lk2, 3, 4 & 5: Fit these jumpers as shown in the table below.

Measurement Range	Link Setting Channel A	Link Setting Channel B
200mV	Lk2 open, Lk3 open	Lk4 open, Lk5 open
2V	Lk2 closed, Lk3 open	Lk4 closed, Lk5 open
20V	Lk2 closed, Lk3 open	Lk4 closed, Lk5 open
4-20mA	Lk2 open, Lk3 closed	Lk4 open, Lk5 closed
Temperature (Low Range)	Lk2 open, Lk3 open	Lk4 open, Lk5 open
Temperature (High Range)	Lk2 open, Lk3 open	Lk4 open, Lk5 open

PIN FUNCTIONS

TxD, RxD: Input and output connections for Infra-Red communications, e.g.: connect to a PANEL-IR module.
 SW: Switch input, normally pulled high. Connect momentarily to V- to take a reading in One-Shot mode or to start logging when configured for Push-to-Start in EL-WIN.
 AV+: Test pin. Do Not Use.
 V-, V+: External power supply connections. Read Important Note below prior to use. External supply voltage range 3 to 3.6Vdc. External power supply must be floating with respect to the signal to be measured.
 HA, LA: Normally at V-, these pins go high when their respective alarm levels have been reached or exceeded.
 VIN-, VIN+: Measurement Inputs, extension of screw terminal block connections.
 Iin, Iout: Current Loop connection, extension of screw terminal block connections.

Rear Pin Header

TxD ● ● RxD
 SW ● ● AV+
 V- ● ● V+
 HA-A ● ● LA-A
 HA-B ● ● LA-B

IMPORTANT NOTE- Always remove the Lithium battery from the module **BEFORE** connecting an external power supply to the module. Failure to do so may cause the battery to explode.

BATTERY REPLACEMENT

Only use ½AA 3.6V lithium. The list below is not exhaustive. Check with supplier that the battery you are ordering is 'press fit' and is not fitted with solder tags. When replacing the battery, remove the serial communications cable and ensure correct orientation of the battery. **DO NOT PRESS ON LCD WHEN INSERTING BATTERY.**

MANUFACTURER	PART NUMBER	MANUFACTURER'S ORDER CODE
MAXELL	ER 35TC	n/a
SAFT	LS3	n/a
SONNENSCHNEIN	SL-750/S	1107 501 100
TADIRAN	½AA/S	1551-02-210-000



WARNING: Handle lithium batteries carefully - observe warnings on battery casing. Dispose of in accordance with local regulations.



APPLICATIONS

NOTE -It is possible for either channel to measure Temperature, Voltage and Current, as outlined below. Parameters other than those outlined below can also be measured. Use an appropriate sensor and conditioning circuit to convert the parameter to be measured into a linear voltage or current and apply this signal to one of the inputs of a suitably scaled EL-3-12BIT module. When measuring Voltage or Current, both channels must share the same signal ground (Vin-).

TEMPERATURE

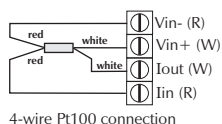
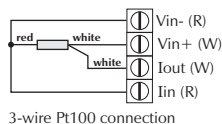
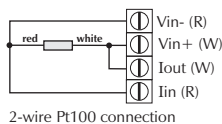

VOLTAGE

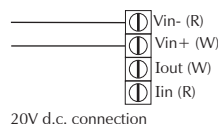
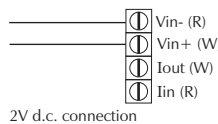
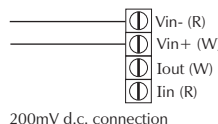

CURRENT

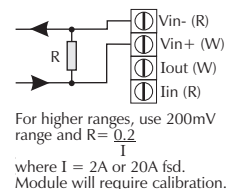
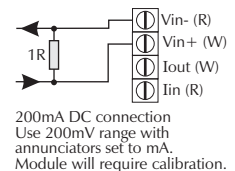
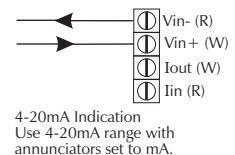

Measurement signals must always be isolated from the communications signals.
 See Link table for appropriate Link Settings.