

# CSS-ARCH-MANUAL-SLIM

## Architectural Slim Manual Shades

Versatile, chain-operated shade with a slim hardware design

Ideal for mounting between window jambs or inside smaller pockets

Decorative curved or square fascia and optional top back cover

End caps come in a variety of finishes

**NOTE: “CSS-ARCH-MANUAL-SLIM” is sold as part of a custom-configured product and orders are placed via the Crestron® Design Tool for Crestron Shading Solutions. This specifications page is for informational purposes and shows the available parts of an Architectural Slim Manual Shade. To configure shades or order shading parts and accessories, please use the Crestron Design Tool for Crestron Shading Solutions or call 1-855-53-S-H-A-D-E (537-4233) for support.**

Architectural Slim Manual Shades from Crestron® are suitable for wall and ceiling mounting, but are ideal for installing between window jambs or inside smaller pockets because of their compact mounting brackets and hardware. Available extrusions include square or curved fascia, with an optional top back cover. In addition, matching end caps come with the order of a fascia.

### Slim Brackets

The shade assembly is mounted using the supplied pair of Slim mounting brackets. One bracket is designed for the idler end of the shade assembly and one for the clutch end. For easy drilling and mounting, the brackets have slotted sides.

### Fascia & Top Back Cover

Fascia can be square or curved and is tensioned fit to snap onto the slim brackets. It both camouflages the roller shade and allows access for adjustment and maintenance. A top back cover is available with fascia as part of a two-piece assembly and is suitable for surface mounting to a header, jamb, or wall. End caps are curved or square to match fascia design.

### Chain & Chain Tension Device

The chain that operates the shade comes standard in a stainless steel finish. A chain tension device (or “chain guide”) ensures the chain is kept in place and does not interfere with shade operation. It secures to the wall, window frame, or floor to remove slack from the chain. Setting upper and lower limits of the shade is done with stop balls, which are installed onto the chain.

### SPECIFICATIONS

ITEM	HEIGHT	WIDTH	LENGTH	FINISH
<b>Slim Brackets</b>	3 3/4" (95 mm)	3 1/4" (83 mm)	11/16" (17 mm)	Metal; White, Ivory, Clear Anodized, Black, Bronze
<b>Slim Square Fascia</b>	3 13/16" (97 mm)	1 3/16" (31 mm)	Maximum 192" (4877 mm)	Metal; White, Ivory, Clear Anodized, Black, Bronze
<b>Slim Curved Fascia</b>	3 3/4" (96 mm)	1 3/16" (31 mm)	Maximum 192" (4877 mm)	Metal; White, Ivory, Clear Anodized, Black, Bronze
<b>Slim Square/Curved End Caps</b>	Designed to match fascia			Plastic; White, Ivory, Clear Anodized, Black, Bronze
<b>Slim Top Back Cover</b>	3 15/16" (100 mm)	3 5/16" (85 mm)	Maximum 192" (4877 mm)	Metal; White, Ivory, Clear Anodized, Black, Bronze

NOTE: Actual maximum shade size is dependent on fabric chosen.

### MOUNTING HARDWARE & ACCESSORIES

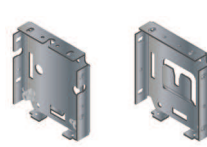

Slim Brackets

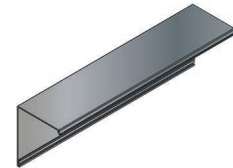

Top Back Cover

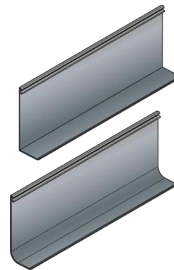

Curved or Square Fascia



Square or Curved End Caps

### Crestron Shading Solutions Safety Information

Crestron's manual shades are sold with a chain tension device connected to the shade's looped operating chain. If the chain tension device is not attached to the wall or floor, the shade will not function properly.

A chain tension device reduces the risk of a young child becoming entangled in the operating chain. This device should be used with all looped operating chains on window shades in any environment in which children are or may be present.

Crestron is committed to providing customers with products of the highest quality and workmanship. Safety is important to us, and we are proud to say that safety issues are rare. We will continue to work with organizations such as the Window Covering Safety Council to identify areas where products can benefit from enhanced safety features.

# CSS-ARCH-MANUAL-SLIM Architectural Slim Manual Shades

The Window Covering Safety Council (WCSC) and the U.S. Consumer Product Safety Commission (CPSC) are recommending that only cordless window coverings or those with inaccessible cords be used in homes with young children.

Important Safety Guidelines can be found at [www.windowcoverings.org](http://www.windowcoverings.org)

## AVAILABLE MODELS

CSA-BRKT-ARCH-SM: Slim Bracket  
CSA-FASCIA-SM-SQR: Slim Square Fascia  
CSA-FASCIA-SM-SQR-EC: Slim Square Fascia End Caps  
CSA-FASCIA-SM-CRV: Slim Curved Fascia  
CSA-FASCIA-SM-CRV-EC: Slim Curved Fascia End Caps  
CSA-FASCIA-SM-TBC: Slim Top Back Cover

Notes: The specific patents that cover Crestron products are listed online at: [patents.crestron.com](http://patents.crestron.com).

Crestron and the Crestron logo are either trademarks or registered trademarks of Crestron Electronics, Inc. in the United States and/or other countries. Other trademarks, registered trademarks, and trade names may be used in this document to refer to either the entities claiming the marks and names or their products. Crestron disclaims proprietary interest in the marks and names of others. Crestron is not responsible for errors in typography or photography. Specifications are subject to change without notice. ©2014 Crestron Electronics, Inc.

<b>⚠ WARNING</b>	
	The cords on this product present a potential strangulation hazard.
	For child safety, consider cordless alternatives or products with inaccessible cords.
<b>⚠ ADVERTENCIA</b>	
	Los cordones de este producto representan un peligro potencial de estrangulamiento.
	Para la seguridad de los niños, utilice alternativas sin cordón o productos cuyos cordones sean inaccesibles.
<b>⚠ MISE EN GARDE</b>	
	Les câbles de ce produit représentent un danger potentiel de strangulation.
	Pour la sécurité des enfants, pensez au sans fil, ou procurez-vous des produits dont les câbles ne sont pas accessibles.

# CSS-ARCH-MANUAL-SLIM Architectural Slim Manual Shades

## CAD DRAWINGS

### Architectural Slim Manual Shade Assembly

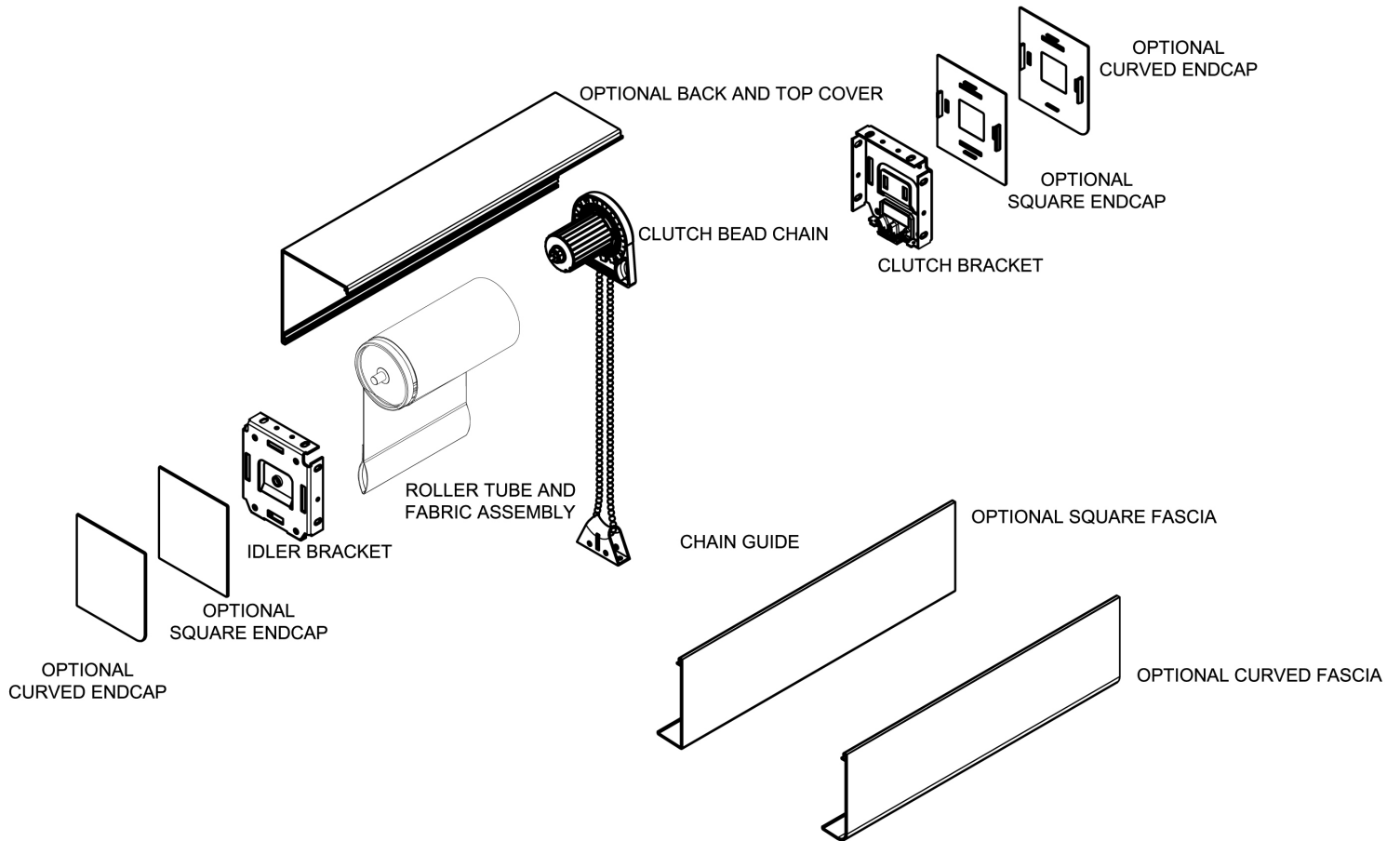

# CSS-ARCH-MANUAL-SLIM Architectural Slim Manual Shades

## MOUNTING CONDITIONS

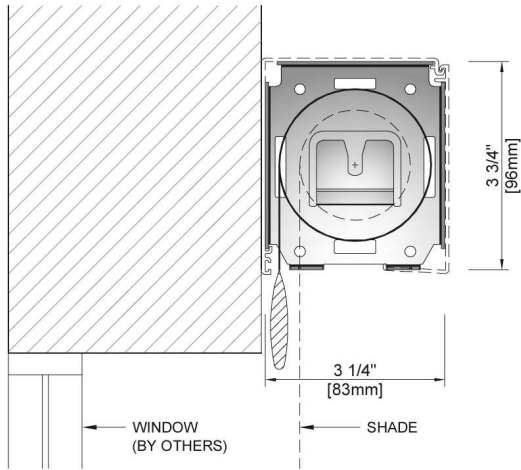

**WALL MOUNT**

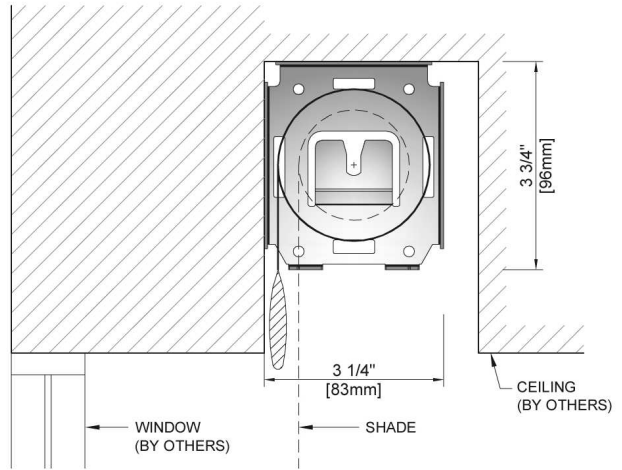

**CEILING MOUNT**

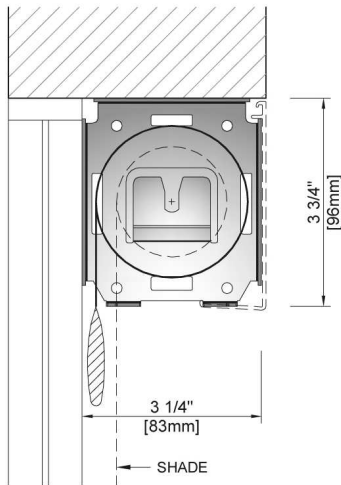

**INSIDE FRAME MOUNT**

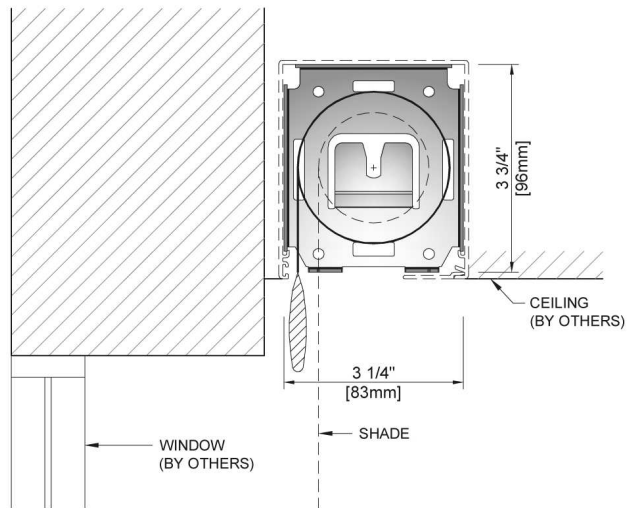

**POCKET MOUNT**