

LCD Panel Display PT30 Series

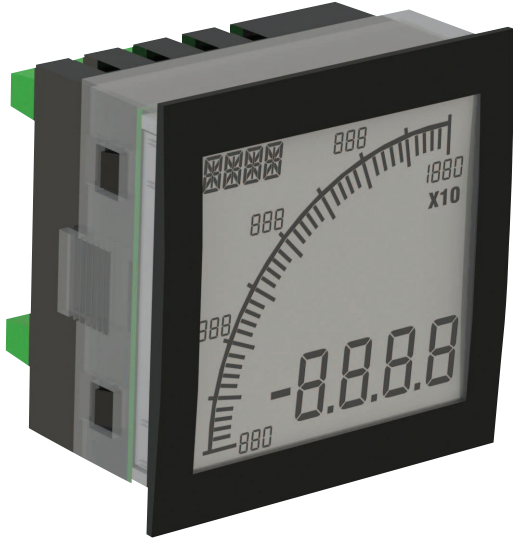

PT30

ENM's PT30 is a panel meter which can display voltage, amperage, or frequency using a digital readout and graph.

With high accuracy and readability, the PT30 is ideal for any panel mounted application which requires monitoring crucial data such as voltage, amperage, or frequency.

Specifications

Input Range(DC):	0-600V, 0-5A(peak/RMS)
Input Range(AC):	0-528V, 0-5A(peak/RMS), 0-400Hz
Power Input:	12-24 VAC/VDC
Digits:	4 digits, 0.47" height
Character:	4 characters
Backlight:	Green
Temperature:	-10 to +60°C (operating) -40 to +70°C (storage)
Model with outputs:	
Max voltage:	24V
Max current:	50mA
Analog output:	4-20mA

Features

- 40 segments bar graph display
- Large 4 digits display
- Starburst display for text
- IP65 (from the front)

*Please inquire with ENM sale representative for customize meter. Customer can request changes to the following:

- Backlight: (Red/Green/White)
- Two alarm set points
- Custom display text
- Custom min/max range and scale (offset&gain) on graph

Voltage Description

PT30A0A	Voltmeter w/ pos. LCD bias
PT30A1A	Voltmeter w/ pos. LCD bias & output
PT30A0B	Voltmeter w/ neg. LCD bias
PT30A1B	Voltmeter w/ neg. LCD bias & output

Amperage Description

PT30B0A	Ammeter w/ pos. LCD bias
PT30B1A	Ammeter w/ pos. LCD bias & output
PT30B0B	Ammeter w/ neg. LCD bias
PT30B1B	Ammeter w/ neg. LCD bias & output

Frequency Description

PT30C0A	Freq. meter w/ pos. LCD bias
PT30C1A	Freq. meter w/ pos. LCD bias & output
PT30C0B	Freq. meter w/ neg. LCD bias
PT30C1B	Freq. meter w/ neg. LCD bias & output

PT30 Series

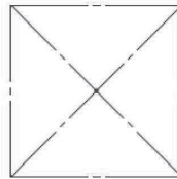
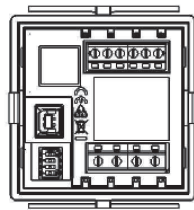
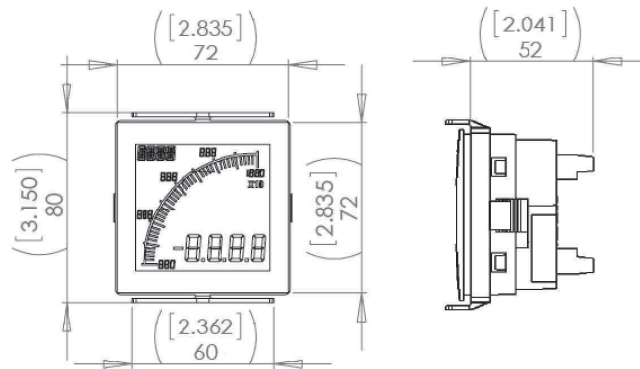

Recommended Panel Cut-out
68 x 68mm (2.68in) +0.7(0.03in) -0mm

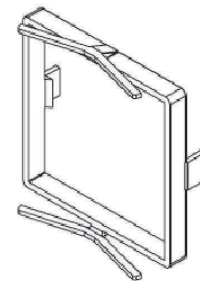
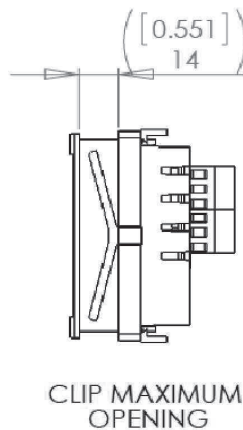
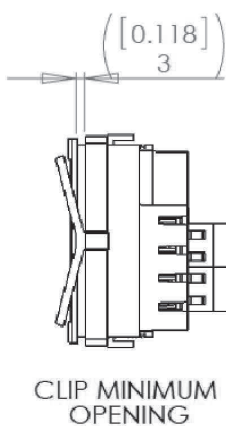

2014 ENM Co.®

LIMITED WARRANTY

ENM Company resettable electromechanical counters are warranted to the consumer to be free from defects in material and workmanship for a period of 3 years or 10,000 hours. All ENM products which fall within the warranty period due to defects in material or workmanship will be repaired or replaced, at ENM's option, without charge to the consumer when returned with proof of purchase to any authorized ENM dealer in the United States, transportation charges prepaid, provided there is no evidence of improper installation, tampering, or other abuse. All implied warranties, including any implied warranty of merchantability or fitness for a particular purpose, shall be limited in duration to the express warranty period specified above. ENM disclaims any liability for consequential damages due to breach of any written or implied warranty on its products. Datasheet information subject to change.