

Elapsed Time Indicator

Technical Data

Motor Driven T12 Series

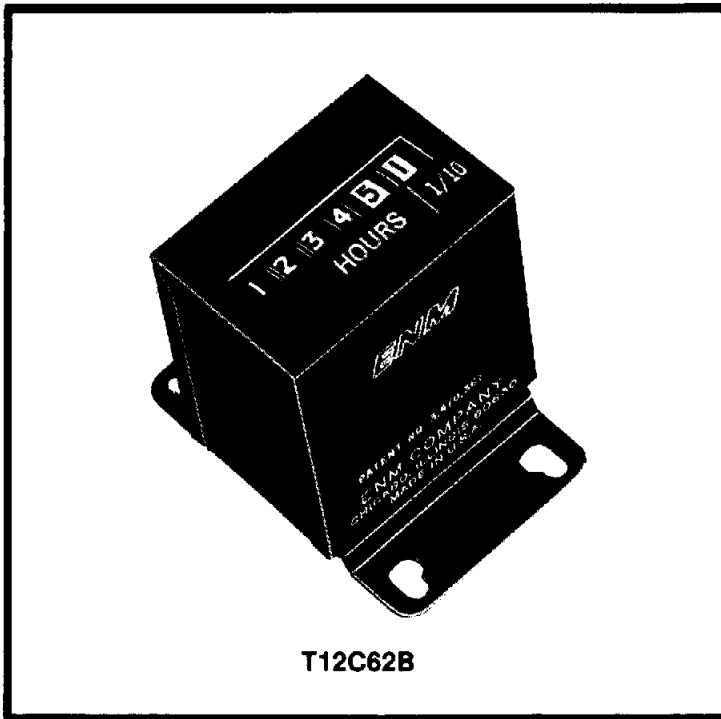

T12C62B

Dependable, Low Cost Hour Meter

For warranty control, maintenance scheduling, process timing or establishing rental fees, ENM has put it all together for you in a small package, which is no small achievement. Here's everything you've ever wanted in an elapsed time indicator that records to 100,000 hours. Forward thinking epicyclic gearing conserves space in an easy-to-read six digit indicator, including tenths of hours, in a compact device only 1.7" wide.

The versatile CompaC T12 is interchangeable with competitive devices and may be base mounted or back panel mounted for multiple stacking in minimum space. Or add a bezel for front panel mounting.

- Compact device indicates/records to 100,000 hours
- Epicyclic step-down gearing conserves space
- Indicates tenths of hours in relief
- For back of panel, base mounting or panel mounting
- Lubricated for life
-  listed

TECHNICAL FEATURES

Time Scale:	99,999.9 hours, standard
Figures:	Hours, white on black; tenths, black on white, .140" high
Voltage:	115 V., 60 Hz., others available
Power:	1 Watt
Drive:	Synchronous motor
Reset:	None
Mounting:	Universal base, back of panel or front of panel
Dimensions:	1.7" wide x 1.2" high x 2.3" deep. Wt. 6 oz.

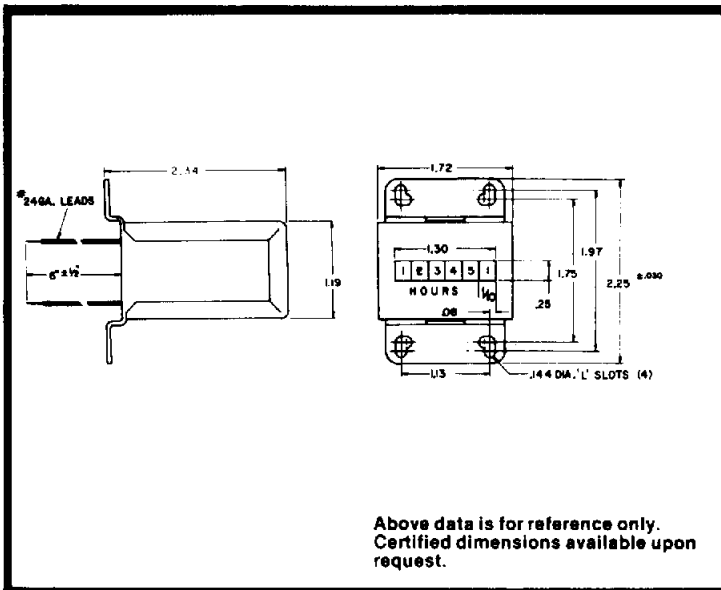

Above data is for reference only. Certified dimensions available upon request.

Mounting variations shown on other side.

Consult our engineering staff for application assistance, modifications or additional features.

 Recognized under the Component Program of Underwriters Laboratories Inc.

© 1989 ENM Co.



ENM Company

5617 Northwest Highway

Chicago, IL 60646

Phone: (312) 775-8400

TELEX: 25-4068 FAX: (312) 775-5968

Mounting Variations

Technical Data

Model T12

**T12B62B
Panel Mount**

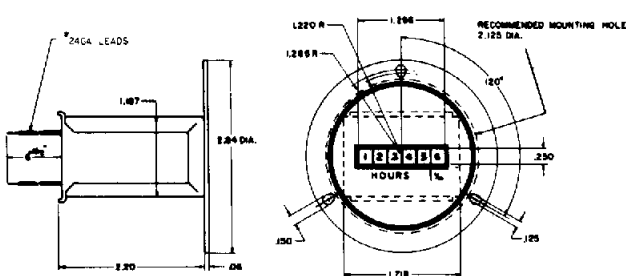

**T12D62B02
Back of Panel Mount Without Legs**

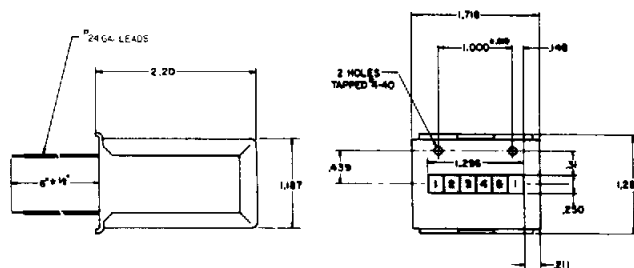

**T12C62B
Base Mount**

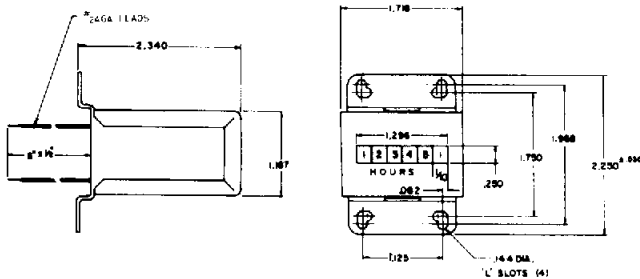

**T12D62B07
Flange Mount**

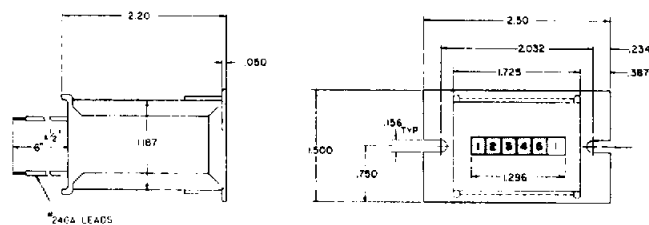

**T128F62B
NEMA Bezel Panel Mount**

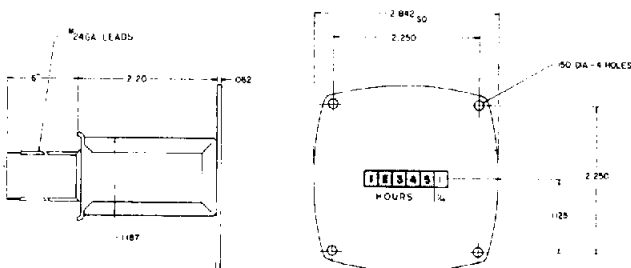

OPTIONS AVAILABLE

- Time Scale:** 9,999.99 hours
- Voltage:** 115 V., 50 Hz.; 24 V., 60 Hz.;
- 24 V., 50 Hz.; 230 V., 50 Hz.;
- 230 V., 60 Hz.

Above data is for reference only.
Certified dimensions available upon request.

