

Features:

- With built-in PFC
- Only 1.4 inch height
- With ITE & Medical (-M) safety
- Efficiency between 86% to 88%
- Operation from -20°C to 70°C by convection
- 380W peak load capability for 8 seconds

Applications:

- For dental, laboratory products, pumps, monitors, sleep apnea devices and many other uses.

General Specifications:

Input voltage 90 VAC to 264 VAC
 Input frequency 47 Hz to 63 Hz
 Inrush current < 30A at 115VAC
 (cold start at 25°C) or < 60A at 230VAC
 Efficiency 86%~88% depends on models
 Hold up time > 20 ms
 at rated load and 115VAC
 Over load protection auto recovery
 Short circuit protection auto recovery
 Over temperature protection auto recovery

Over voltage protection latch off
 Capacitance load capability up to 100000uF
 Operating temperature (open frame type) -20°C to 70°C
 derating: 2.5% / °C > 50°C
 Cooling 200W free air convection
 300W 5.2 CFM x 2 forced air
 Storage temperature -40°C to +85°C
 EMI EN55022 "B", FCC "B"
 Harmonics..... EN61000-3-2 class D
 EMS..... EN61000-4-2,-3,-4,-5,-6,-11
 Safety UL/CSA/IEC60950-1, 2nd edition
 ANSI/AMMI/CSA/IEC60601-1, 3rd edition

Mechanical Specifications:

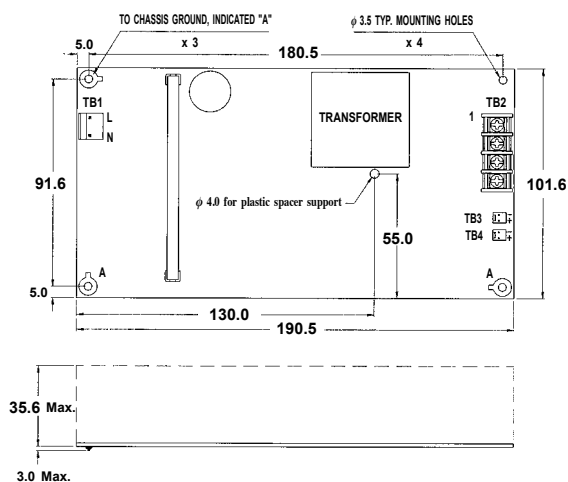

Notes:

1. Dimensions shown in mm as left. Tolerance: ±0.4mm (Excluding cables).
2. Size:
101.6 x 190.5 x 35.6 (mm)
4" x 7.5" x 1.4"
3. Packing:
Net weight: 475 g approx. / unit
Gross weight: 14.5 kg approx. / carton, 24 units / carton
Carton size (mm): 489 (L) x 357 (W) x 285 (H)
4. Connectors:
AC input : Molex 5277-02A or equivalent
DC output: Molex 5273-10A or equivalent (for +30V, +38V, +48V and +60V)
Terminal Blocks, pitch 8.25 mm (for +12V, +15V, +18V and +24V)
Fan, Remote sense: Molex 5045-02A or equivalent
5. Output Pin assignment:

PIN NO.	1	2	3	4	5	6	7	8
SNP-X207	GND	GND	+12V	+12V				
SNP-X208	GND	GND	+15V	+15V				
SNP-X205	GND	GND	+18V	+18V				
SNP-X209	GND	GND	+24V	+24V				
SNP-X20G	GND	GND	GND	GND	+30V	+30V	+30V	+30V
SNP-X20J	GND	GND	GND	GND	+38V	+38V	+38V	+38V
SNP-X20T	GND	GND	GND	GND	+48V	+48V	+48V	+48V
SNP-X20H	GND	GND	GND	GND	+60V	+60V	+60V	+60V

-Steven-

10 years Warranty (contact Skynet's Distributors for details)

Output Specifications:

MODEL NO.	OUTPUT RAIL	LOAD				FACTORY ADJUSTMENT	RIPPLE NOISE	LINE REG.	LOAD REG.	EFFICIENCY TYPICAL
		MIN.	RATED	MAX.	PEAK					
SNP-X207 SNP-X207-M	+12V	0A	16.5A	25A	31.5A	+11.9V~+12.1V	100mVpp	±1%	±1%	86%
SNP-X208 SNP-X208-M	+15V	0A	13.3A	20A	25A	+14.9V~+15.1V	100mVpp	±1%	±1%	88%
SNP-X205 SNP-X205-M	+18V	0A	11.1A	16.6A	21A	+17.9V~+18.1V	100mVpp	±1%	±1%	88%
SNP-X209 SNP-X209-M	+24V	0A	8.3A	12.5A	15.8A	+23.9V~+24.1V	100mVpp	±1%	±1%	87%
SNP-X20G SNP-X20G-M	+30V	0A	6.6A	9.65A	12.6A	+29.9V~+30.1V	150mVpp	±1%	±1%	86.5%
SNP-X20J SNP-X20J-M	+38V	0A	5.25A	7.9A	10A	+37.8V~+38.2V	150mVpp	±1%	±1%	87%
SNP-X20T SNP-X20T-M	+48V	0A	4.16A	6.25A	7.9A	+47.8V~+48.2V	200mVpp	±1%	±1%	87%
SNP-X20H SNP-X20H-M	+60V	0A	3.3A	5A	9.15A	+59.7V~+60.3V	100mVpp	±1%	±1%	87%

Note:

1. To exceed the max. output power continuously is not allowed.
2. At factory, in 60% rated load condition, each output is checked to be within voltage accuracy.
3. Line regulation is defined by changing ±10% of input voltage from nominal line at rated load.
4. Load regulation is defined by changing ±40% of measured output load from 60% rated load at another output set to 60% rated load.
5. Ripple & noise is measured by using 15MHz bandwidth limited oscilloscope and terminated each output with a 0.47uF capacitor at rated load and nominal line.
6. Hold up time is measured from the end of the last charging pulse to the time which the main output drops down to low limit of main output at rated load and nominal line.
7. Efficiency is measured at rated load and nominal line.
8. SNP-X20H is designed for audio power amp. Peak load duration is 400ms max.
9. For SNP-X208, max. fan output current is 0.1A; for other models, 0.2A.

Performance for SNP-X207 (input voltage is 115VAC, unless others specified):

1. Switching frequency ripple

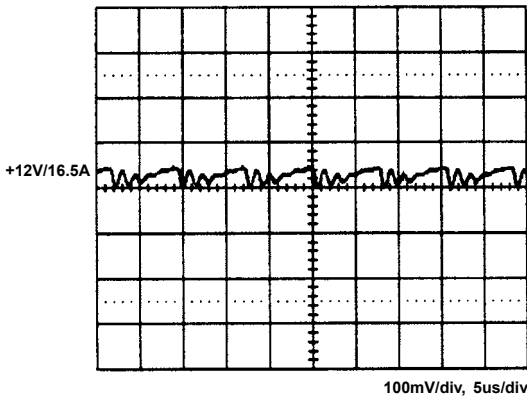

2. Line frequency ripple

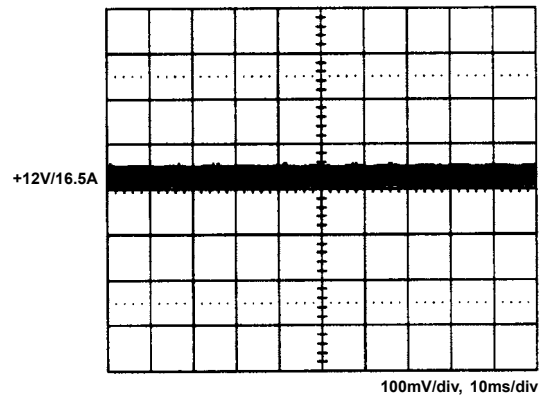

3. Output turn on wave form

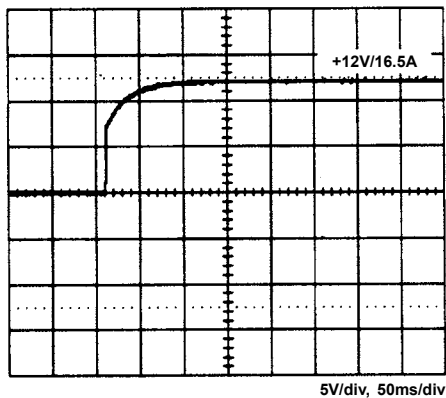

4. Output turn off wave form

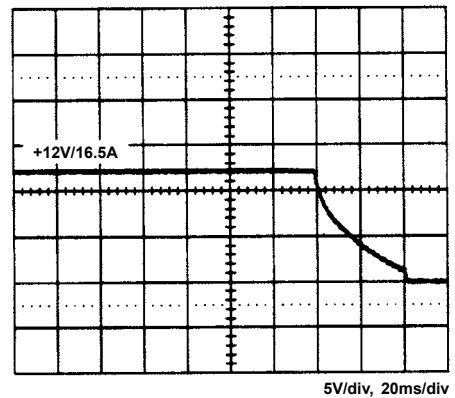

5. Hold up time

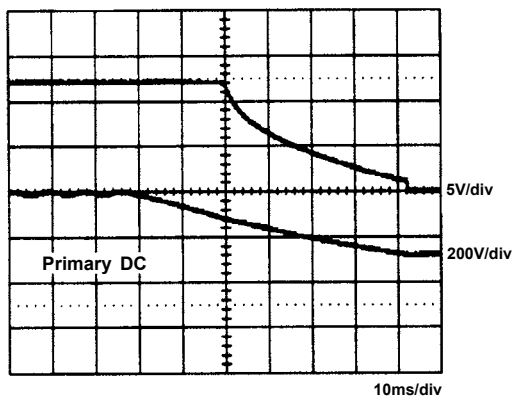

6. Over voltage protection

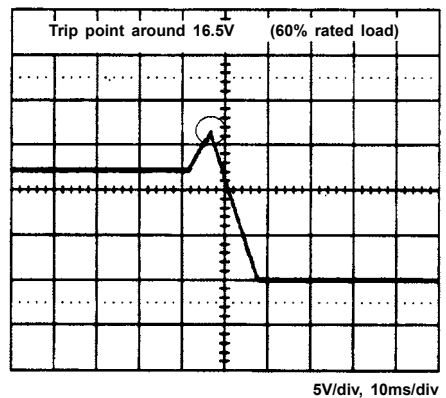

7. +12V step response

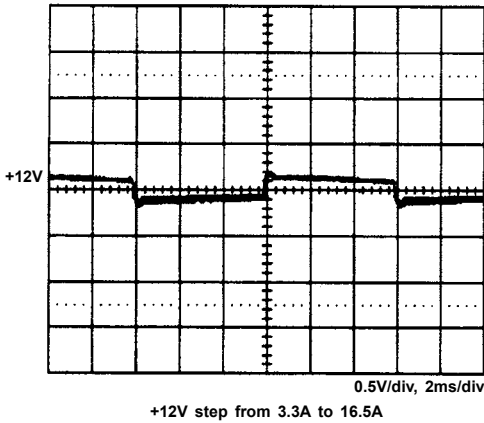

8. Peak Load

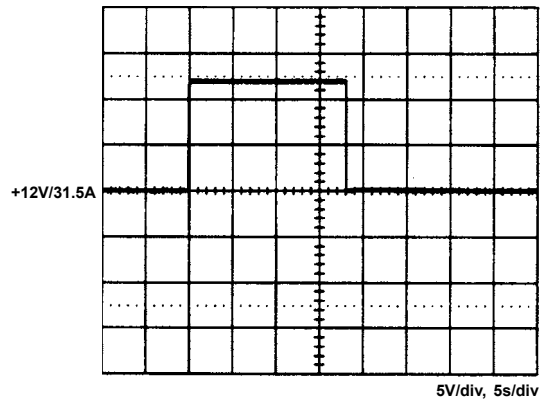

9. FCC B

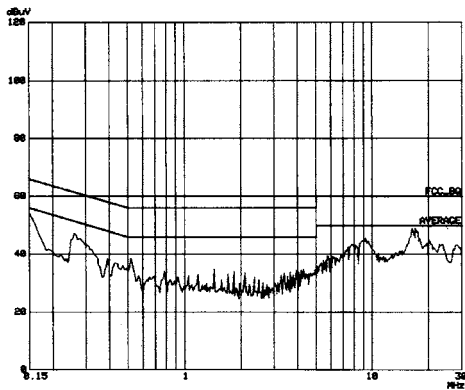

10. CISPR 22 B

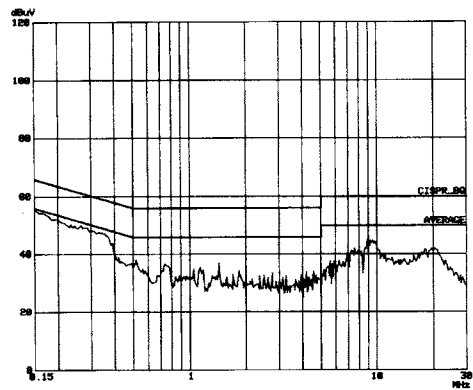

11. Power derating curve

