

1

2

3

4

5

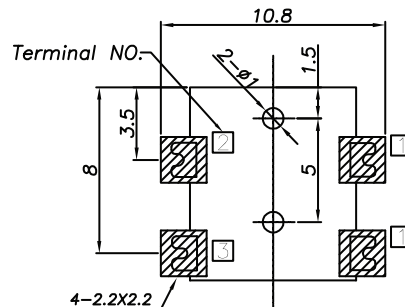
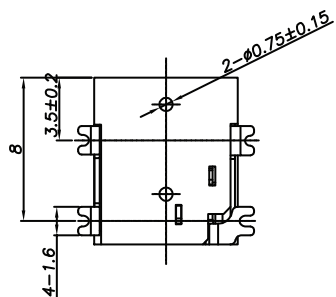

PCB LAYOUT - COMPONENT VIEW
TOLERANCE ± 0.05

TECHNICAL CHARACTERISTICS

MATERIAL
INSULATOR: PA 9T
FLAMABILITY RATING: UL94-V0
COLOR: BLACK
CONTACT MATERIAL: COPPER ALLOY
CONTACT TYPE: STAMPED
PLATING:
- CENTER PIN: GOLD
- CENTER PIN TERMINAL: TIN
- SHUNT TERMINAL: TIN
- TIP SPRING: TIN
QUALITY CLASS: 5000 MATING CYLCES

ENVIRONMENTAL
OPERATING TEMPERATURE: -40°C UP TO +85°C
COMPLIANCE: LEAD FREE AND ROHS

ELECTRICAL
CURRENT RATING: 5A
WORKING VOLTAGE: 18 VDC
INSULATION RESISTANCE: >100 MΩ
DIELECTRIC WITHSTANDING VOLTAGE: 500 VAC/MIN
CONTACT RESISTANCE: 50 mΩ max

SOLDERING
JEDEC LEAD FREE REFLOW SOLDERING PROCESS

PACKAGING
TAPE & REEL

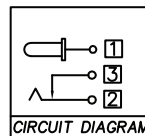
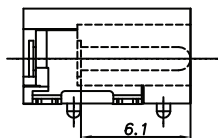
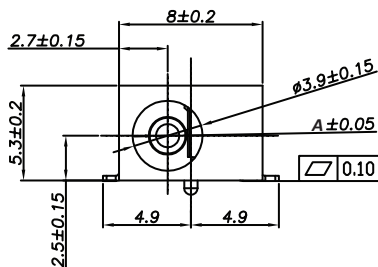
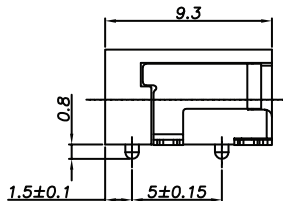

CIRCUIT DIAGRAM

□ : TERMINAL NO.

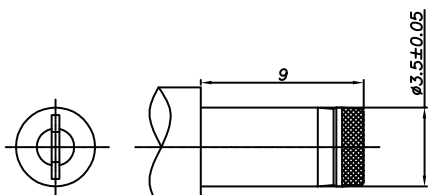

DC MATE PLUG

∅ A	1.0	1.3
XX	02	03
PLUG INNER ∅	1.05 ^{+0.10} _{-0.00}	1.35 ^{+0.10} _{-0.00}
PLUG OUTER ∅	3.5±0.05	3.5±0.05

RoHS Compliant

G			
F			
E			
D			
C			
B			
A	08-SEP-14	PDF	AS
REV	DATE	FILE	BY

PROJECTION:	
APPROVAL: RJ	

GENERAL TOLERANCE
X = +/_ 0.50
.X = +/_ 0.30
.XX = +/_ 0.20
UNIT: MM
SCALE:
SHEET: 1/1
DRAW: AS

DESCRIPTION: DC POWER JACK - RIGHT ANGLED - SMT - 1.0 & 1.3∅	SIZE A4
WERI PART NO: 694 1xx 107 102	

A

B

C

D

1

2

3

4

5

Cautions and Warnings:

This electronic component is designed and developed with the intention for use in general electronics equipments.

Before incorporating the components into any equipments in the field such as aerospace, aviation, nuclear control, submarine, transportation, (automotive control, train control, ship control), transportation signal, disaster prevention, medical, public information network etc. where higher safety and reliability are especially required or if there is possibility of direct damage or injury to human body, Würth Elektronik must be asked for a written approval.



In addition, even electronic component in general electronic equipments, when used in electrical circuits that require high safety, reliability functions or performance, the sufficient reliability evaluation-check for the safety must be performed before by the user before usage.

A

B

C

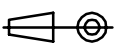
RoHS Compliant

G				PROJECTION: 	GENERAL TOLERANCE .X = +/- 0.2 .XX = +/- 0.15		
F							
E							
D							
C				APPROVAL: JC	UNIT: MM	DESCRIPTION: DISCLAIMER	SIZE A4
B					SCALE:		
A	10-SEP-14	PDF	QL		SHEET: 1/1	WERI PART NO: DISCLAIMER	
REV	DATE	FILE	BY		DRAW: QL		

D

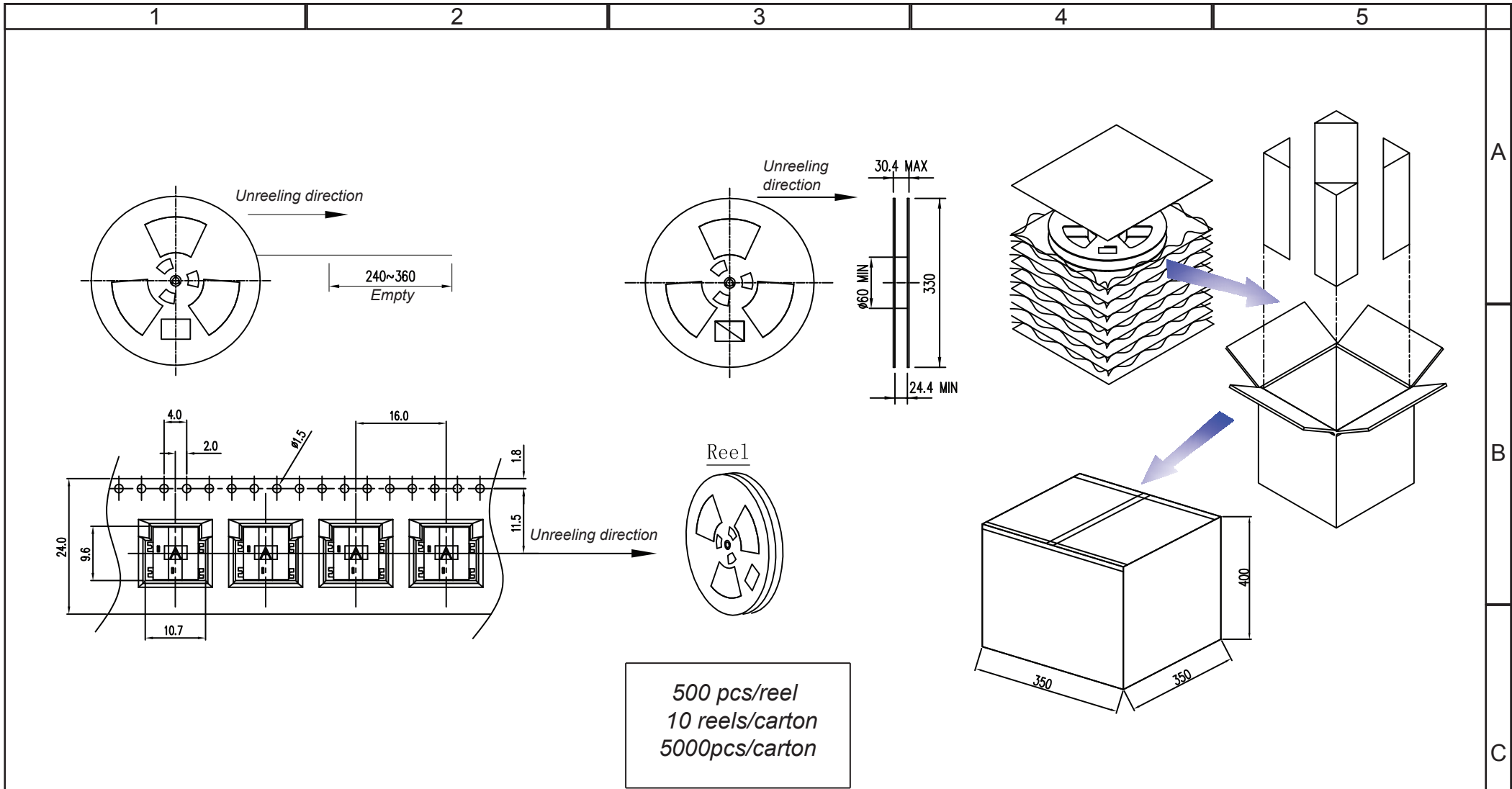

RoHS Compliant			
G			
F			
E			
D			
C			
B			
A	22-JUL-14	PDF	AS
REV	DATE	FILE	BY

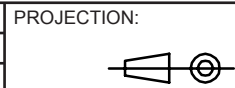

APPROVAL: RJ

GENERAL TOLERANCE

.X = +/- 0.2

.XX = +/- 0.15



DESCRIPTION: DC POWER JACK - RIGHT ANGLED - SMT - 1.0 & 1.3Ø

WERI PART NO: 694 1xx 107 102

SIZE

A4