

1

2

3

4

5

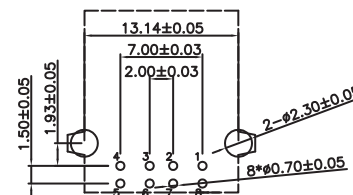
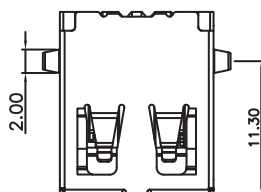
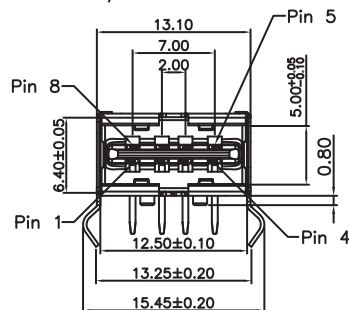
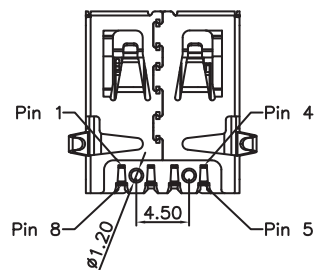
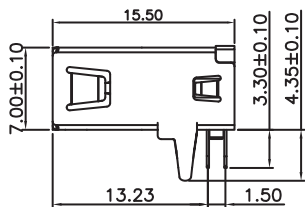
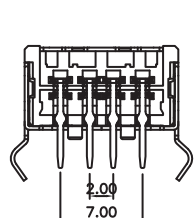

TECHNICAL CHARACTERISTICS

MATERIAL
 INSULATOR: LCP
 FLAMMABILITY RATING: UL94-V0
 COLOR: BLACK
 CONTACT MATERIAL: COPPER ALLOY
 CONTACT TYPE: STAMPED
 CONTACT PLATING: SELECTIVE GOLD
 LATCH: STAINLESS STEEL Ni PLATED
 QUALITY CLASS: 1500 MATING CYCLES

ENVIRONMENTAL
 OPERATING TEMPERATURE: -40°C UP TO +105°C
 COMPLIANCE: LEAD FREE AND ROHS

ELECTRICAL
 CURRENT RATING: 1.5 A
 WORKING VOLTAGE: 30 VAC
 INSULATOR RESISTANCE: >1000 MΩ
 DIELECTRIC WITHSTANDING VOLTAGE: 500 VAC/MIN
 CONTACT RESISTANCE: 30 mΩ MAX

STANDARD
 CERTIFIED: E323964

SOLDERING
 JEDEC LEAD FREE WAVE SOLDERING

PACKAGING
 TAPE & REEL

NOTE : 8 separated wirings are necessary to be connected to the USB controller. Subsequently, you need to connect to two ports on the controller.

Pin Assignments

Pin	Signal Name	Description
1 & 5	VCC	+5VDC
2 & 6	D-	Data-
3 & 7	D+	Data+
4 & 8	GND	Ground

RoHS Compliant

G			
F			
E			
D	27-OCT-14	REVIEW	QL
C	23-MAY-13	NOTE ADD	QL
B	15-FEB-13	DESIGNATION	AR
A	08-JUL-12	PDF	GG
REV	DATE	FILE	BY

PROJECTION:

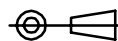

APPROVAL: NPR

GENERAL TOLERANCE

.X = +/- 0.2

.XX = +/- 0.15



DESCRIPTION: USB 2.0 HORIZONTAL DUAL-WAY

WERI PART NO: 614 108 247 221

SIZE

A4

