

1

2

3

4

5

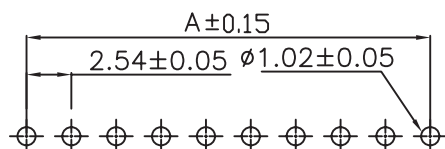
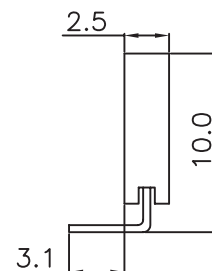
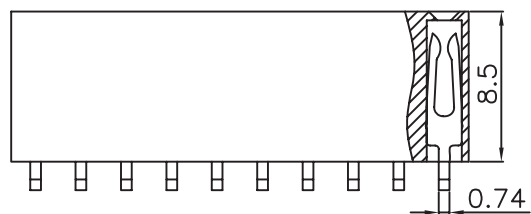
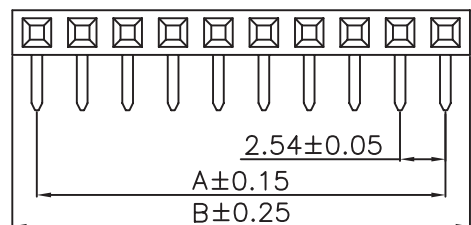

PCB LAYOUT - COMPONENT VIEW

TECHNICAL CHARACTERISTICS

MATERIAL
 INSULATOR: PBT
 FLAMABILITY RATING: UL94-V0
 COLOR: BLACK
 CONTACT MATERIAL: COPPER ALLOY
 CONTACT TYPE: STAMPED
 CONTACT PLATING: GOLD
 QUALITY CLASS: 3 AS PER CECC 75 301-802
 PITCH: 2.54MM

ENVIRONMENTAL
 OPERATING TEMPERATURE: -40 UP TO 125°C
 COMPLIANCE: LEAD FREE AND ROHS



ELECTRICAL
 CURRENT RATING: 3A
 WORKING VOLTAGE: 250V AC
 INSULATOR RESISTANCE: >1000 MOHM
 DIELECTRIC WITHSTANDING VOLTAGE: 500V AC/MN
 CONTACT RESISTANCE: 20 MOHM MAX

SOLDERING
 WAVE PROCESS ONLY

PACKAGING
 TRAY

DIMENSION
 A = 2.54 x (NB. PIN - 1)
 B = 2.54 x (NB. POSITIONS) + 0.5

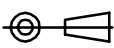
RoHS Compliant

G				PROJECTION: 	GENERAL TOLERANCE .X = +/- 0.2 .XX = +/- 0.15	
F						
E						
D						
C			APPROVAL: RJ	UNIT: MM	DESCRIPTION: 2.54MM ANGLED SOCKET HEADER	SIZE
B	23-AUG-10	PACKAGING	JC	SCALE:	WERI PART NO: 6130 xx 143 121	A4
A	06-NOV-08	PDF	JP	SHEET: 1/2		
REV	DATE	FILE	BY	DRAW: MIKE WU		

A

B

C

D

1

2

3

4

5

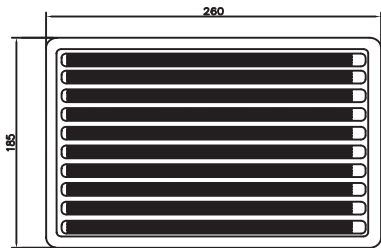
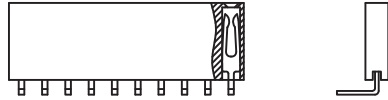
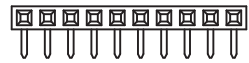

Tray

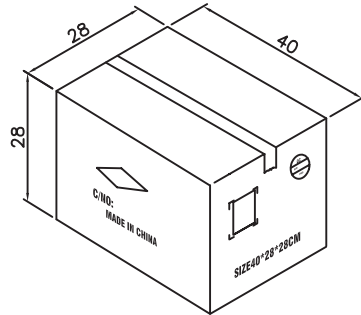
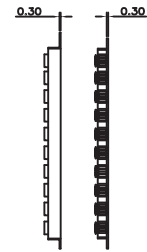
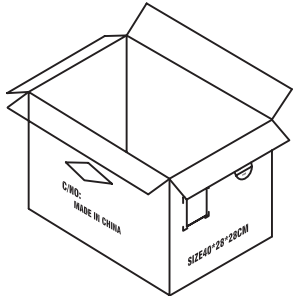

Note

1.Dimension:

Tray Size:260(L)x185(W)x15.5(H) (mm)

Inner Carton Size:254(L)x190(W)x260(H) (mm)

Carton Size:400(L)X280(W)X280(H) mm

2.Quantity

17 Trays/ Inner Carton

2 Inner Carton/Carton

Pin.	Pcs/Tray	Pcs/Inner Carton	Pcs/Carton
2	1560	26520	53040
3	1040	17680	35360
4	800	13600	27200
5	640	10880	21760
6	520	8840	17680
7	440	7480	14960
8	400	6800	13600
9	360	6120	12240
10	320	5440	10880
11-12	280	4760	9520
13-14	240	4080	8160
15-17	200	3400	6800
18-20	160	2720	5440
21-27	120	2040	4080
28-40	80	1360	2720

RoHS Compliant

G			
F			
E			
D			
C			
B			
A			
REV	DATE	FILE	BY

PROJECTION:

GENERAL TOLERANCE
.X = +/- 0.2
.XX = +/- 0.15

APPROVAL: RJ

UNIT: MM
SCALE:
SHEET: 2/2
DRAW: PEARL



DESCRIPTION: 2.54MM ANGLED SOCKET HEADER
WERI PART NO: 6130 xx 143 121_TPK

SIZE
A4

A

B

C

D