



LEDTECH ELECTRONICS CORP.

NANYA ROAD, MUGANG ZHAOQING
CITY GUANGDONG CHINA.

TEL: 86-758-2875541, 2870651, 2877464, 2876185, 2877017

FAX: 86-758-2878014

[Http://www.ledtech.com.tw](http://www.ledtech.com.tw)

SPECIFICATION

PART NO. : LT8VB3-AC-UGE3-S50
HIGH POWER AUTOMATIVE LED



Approved by	Checked by	Prepared by
<i>Tung</i>	<i>Lian</i>	<i>Yu Fang</i>

Package Dimensions

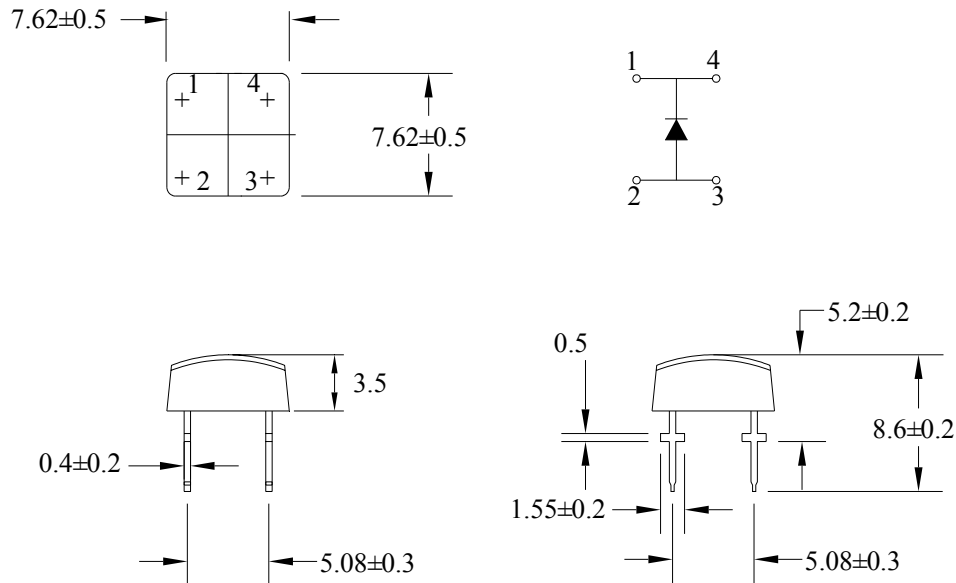

Notes:

1. All dimensions are in mm.
2. Tolerance is ± 0.25 mm unless otherwise noted.

Description

Part No.	LED Chip		Lens Color
	Material	Emitting Color	
LT8VB3-AC-UGE3-S50	InGaN/Sapphire	Blue	Water Clear