



LEDTECH ELECTRONICS CORP.

NANYA ROAD, MUGANG ZHAOQING
CITY GUANGDONG CHINA.

TEL: 86-758-2875541, 2870651, 2877464, 2876185, 2877017

FAX: 86-758-2878014

[Http://www.ledtech.com.tw](http://www.ledtech.com.tw)

SPECIFICATION

PART NO. : LT1823-4D-UDC9-Z

5.0mm ROUND LED LAMP



Approved by

Checked by

Prepared by

Tung

Yang

Haibo

Description

This true green lamp is made with InGaN/Sapphire chip and water clear epoxy resin.

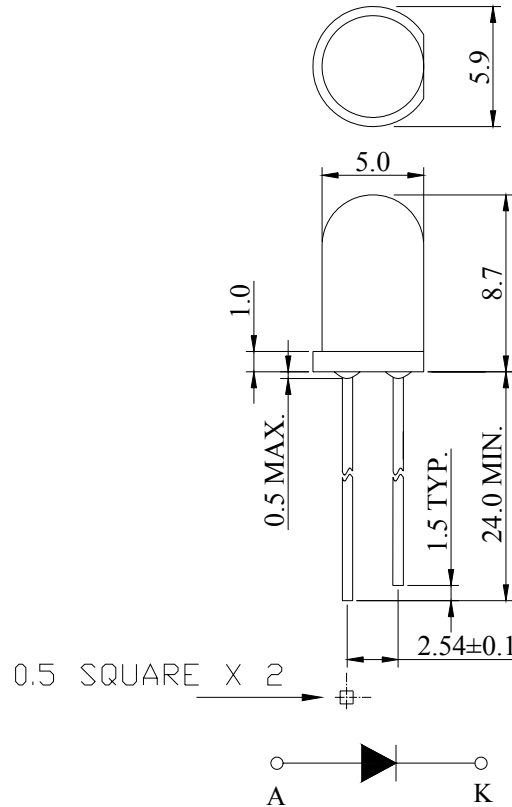
Notes:

1. All dimensions are in mm.
2. Tolerance is ± 0.25 mm unless otherwise noted.

Description

Part No.	LED Chip		Lens Color
	Material	Emitting Color	
LT1823-4D-UDC9-Z	InGaN/Sapphire	True green	Water clear