



LEDTECH ELECTRONICS CORP.

NANYA ROAD, MUGANG ZHAOQING
CITY GUANGDONG CHINA.

TEL: 86-758-2875541, 2870651, 2877464, 2876185, 2877017

FAX: 86-758-2878014

[Http://www.ledtech.com.tw](http://www.ledtech.com.tw)

SPECIFICATION

PART NO. : LT63W3-4D-UEE3-Z

2.9mm ROUND LED LAMP



Approved by	Checked by	Prepared by
<i>Tung</i>	<i>Yang</i>	<i>Haibo</i>

Description

This white lamp is made with InGaN/Sapphire chip and water clear epoxy resin.

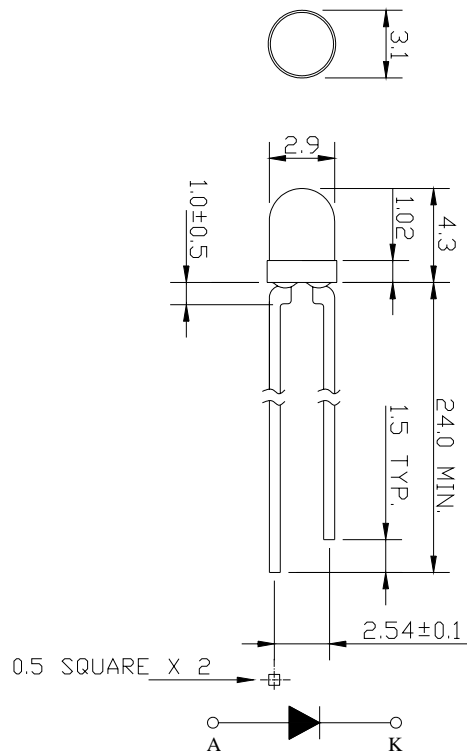
Notes:

1. All dimensions are in mm.
2. Tolerance is ± 0.25mm unless otherwise noted.

Description

Part No.	LED Chip		Lens Color
	Material	Emitting Color	
LT63W3-4D-UEE3-Z	InGaN/Sapphire	White	Water clear