



LEDTECH ELECTRONICS CORP.

NANYA ROAD, MUGANG ZHAOQING
CITY GUANGDONG CHINA.

TEL: 86-758-2875541, 2870651, 2877464, 2876185, 2877017

FAX: 86-758-2878014

[Http://www.ledtech.com.tw](http://www.ledtech.com.tw)

SPECIFICATION

PART NO. : LT3J74-41

2.0mm CYLINDRIC LED LAMP



Approved by

Checked by

Prepared by

Tung

Yang

Haibo

Description

This super red lamp is made with AlGaAs/GaAs chip and red clear epoxy resin.

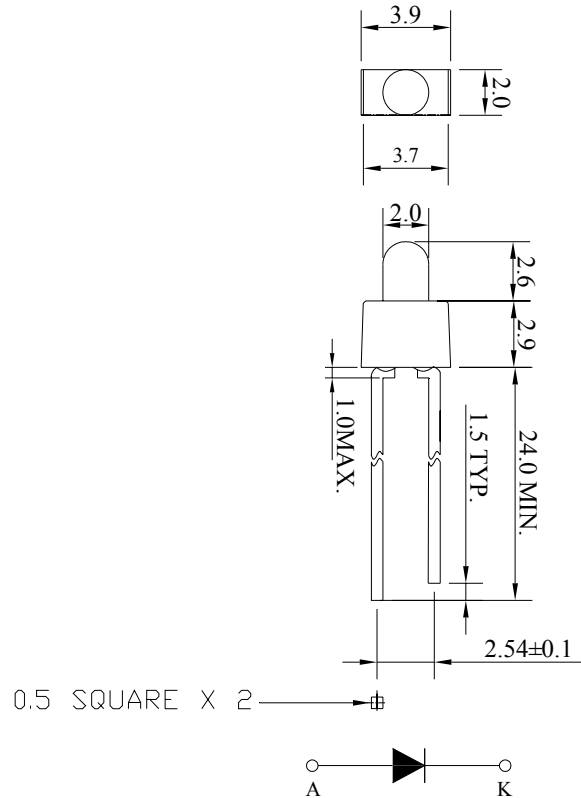

Notes:

1. All dimensions are in mm.
2. Tolerance is ± 0.25 mm unless otherwise noted.

Description

| Part No. | LED Chip | | Lens Color |
|-----------|-------------|----------------|------------|
| | Material | Emitting Color | |
| LT3J74-41 | AlGaAs/GaAs | Super red | Red clear |

Absolute Maximum Ratings at Ta=25°C

| Parameter | Symbol | Rating | Unit |
|---|-----------------------|---|------|
| Power Dissipation | P _D | 66 | mW |
| Reverse Voltage | V _R | 4 | V |
| D.C. Forward Current | I _f | 30 | mA |
| Reverse (Leakage) Current | I _r | 100 | μA |
| Peak Current(1/10Duty Cycle,0.1ms Pulse Width.) | I _f (Peak) | 100 | mA |
| Operating Temperature Range | T _{opr} | -25 to +85 | °C |
| Storage Temperature Range | T _{stg} | -40 to +100 | °C |
| Soldering Temperature(1.6mm from body) | T _{sol} | Dip Soldering : 260°C for 5 sec. Hand Soldering : 350°C for 3 sec. | |

Electrical and Optical Characteristics:

| Parameter | Symbol | Condition | Min. | Typ. | Max. | Unit |
|---------------------------|----------------|----------------------|------|------|------|------|
| Luminous Intensity | I _v | I _f =20mA | 42 | 100 | | mcd |
| Forward Voltage | V _f | I _f =20mA | | 1.8 | 2.2 | V |
| Peak Wavelength | λ _p | I _f =20mA | | 660 | | nm |
| Dominant Wavelength | λ _d | I _f =20mA | | 643 | | nm |
| Reverse (Leakage) Current | I _r | V _r =4V | | | 100 | μA |
| Viewing Angle | 2θ 1/2 | I _f =20mA | | 25 | | deg |
| Spectrum Line Halfwidth | Δλ | I _f =20mA | | 20 | | nm |

Notes:1. The datas tested by IS tester.

2. Customer's special requirements are also welcome.

Typical Electrical / Optical Characteristics Curves :

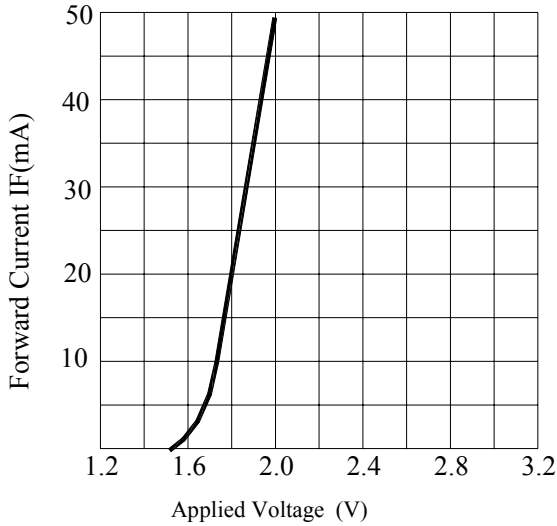

FORWARD CURRENT VS. APPLIED VOLTAGE

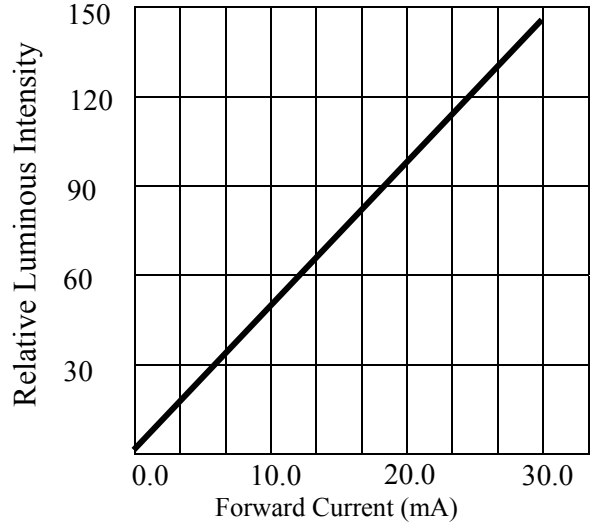

FORWARD CURRENT VS. LUMINOUS INTENSITY

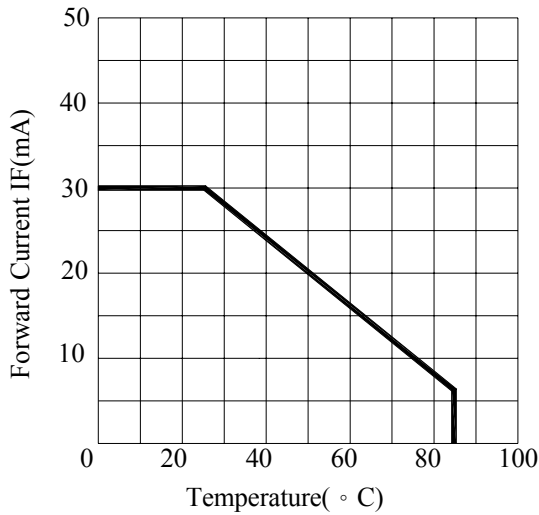

FORWARD CURRENT VS. AMBIENT TEMPERATURE

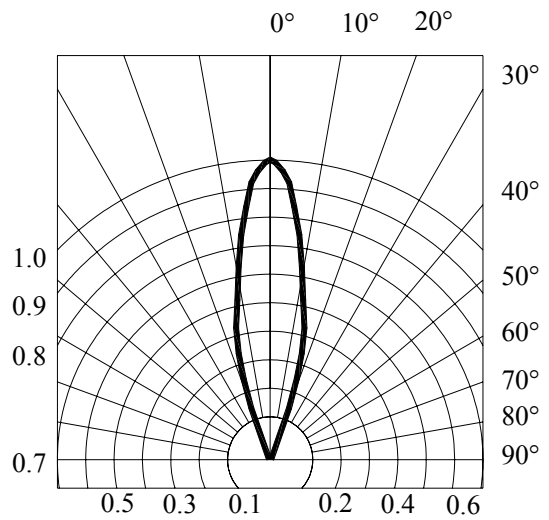

RADIATION DIAGRAM

Precautions:

TAKE NOTE OF THE FOLLOWING IN USE OF LED

1. Temperature in use

Since the light generated inside the LED needs to be emitted to outside efficiently, a resin with high light transparency is used; therefore, additives to improve the heat resistance or moisture resistance (silica gel, etc) which are used for semiconductor products such as transistors cannot be added to the resin.

Consequently, the heat resistant ability of the resin used for LED is usually low; therefore, please be careful on the following during use.

Avoid applying external force, stress, and excessive vibration to the resins and terminals at high temperature. The glass transition temperature of epoxy resin used for the LED is approximately 120-130°C.

At a temperature exceeding this limit, the coefficient of linear expansion of the resin doubles or more compared to that at normal temperature and the resin is softened.

If external force or stress is applied at that time, it may cause a wire rupture.

2. Soldering

Please be careful on the following at soldering.

After soldering, avoid applying external force, stress, and excessive vibration until the products go to cooling process (normal temperature), <Same for products with terminal leads>

(1) Soldering measurements:

Distance between melted solder side to bottom of resin shall be 1.6mm or longer.

(2) Dip soldering :

Pre-heat: 90°C max. (Backside of PCB), Within 60 seconds.

Solder bath: 260±5°C (Solder temperature), Within 5 seconds.

(3) Hand soldering: 350°C max. (Temperature of soldering iron tip), Within 3 seconds.

3. Insertion

Pitch of the LED leads and pitch of mounting holes need to be same.

4. Others

Since the heat resistant ability of the LED resin is low, SMD components are used on the same PCB, please mount the LED after adhesive baking process for SMD components. In case adhesive baking is done after LED lamp insertion due to a production process reason, make sure not to apply external force, stress, and excessive vibration to the LED and follow the conditions below.

Baking temperature: 120°C max. Baking time: Within 60 seconds.

If soldering is done sequentially after the adhesive baking, please perform the soldering after cooling down the LED to normal temperature.

ENCASED TYPE

PLASTIC PACKAGE
QUANTITY: 1000 PCS

| | |
|---------------------------|-------------|
| LEDTECH ELECTRONICS CORP. | |
| PART NO :LTXXXX-XX | |
| Q'TY | : PCS |
| LOT NO | :XXXXXXXXXX |
| DATE | : |
| BIN CODE: | |

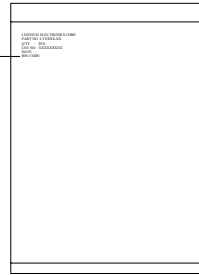

INNER BOX
QUANTITY: 10 PACKETS
TOTAL: 10,000 PCS

| | | | | | |
|----------|--------------|------|------|------|-------|
| PART NO. | LXXXXX-XX-XX | | | | |
| LOT NO. | XXXXXXXXXX | | | | |
| BIN CODE | Xx X | Xx X | Xx X | Xx X | TOTAL |
| QUANTITY | PCS | PCS | PCS | PCS | PCS |
| DATE | XXXX, XX, XX | | | | |

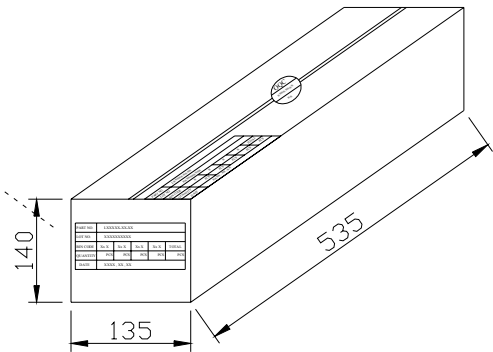

OUTER CARTON
QUANTITY: 4 BOX
TOTAL: 40,000 PCS

| | |
|-----------------|--------------|
| C/T NO. 箱 號 | XX |
| PART NO. 料 號 | LXXXXX-XX-XX |
| QUANTITY 數 量 | PCS |
| N.W. 淨 重 | KGS |
| G.W. 毛 重 | KGS |
| REMARK 備 註 | |

