



LEDTECH ELECTRONICS CORP.

NANYA ROAD, MUGANG ZHAOQING
CITY GUANGDONG CHINA.

TEL: 86-758-2875541, 2870651, 2877464, 2876185, 2877017

FAX: 86-758-2878014

[Http://www.ledtech.com.tw](http://www.ledtech.com.tw)

SPECIFICATION

PART NO. : LP3HN3-ST-UES3-S20

3W HIGH POWER LED



Approved by

Checked by

Prepared by

王方波

蘇智良

陳祥銘

Package Dimensions

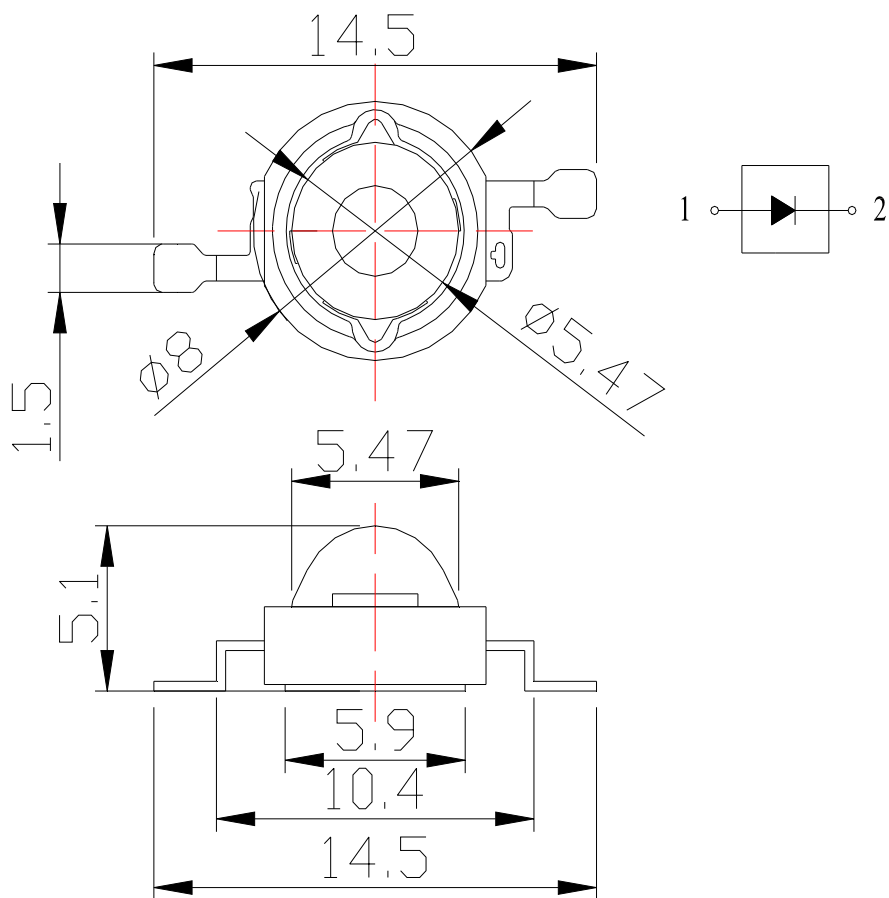

Notes:

1. All dimensions are in mm.
2. Tolerance is +/-0.6mm unless otherwise noted.

Description

Part NO.	LED Chip		Lens Color
	Material	Color Coordinates	
LP3HN3-ST-UES3-S20	InGaN/ Sapphire	White	Water Clear

Absolute Maximum Ratings at Ta=25°C :

Parameter	Rating	Unit
Power Dissipation	2730	mW
LED Junction Temperature	120	°C
Reverse Voltage	5	V
D.C. Forward Current	700	mA
Pulsed Forward Current ; $t_p \leq 100\mu s, \text{Duty cycle}=0.005$)*1	1000	mA
Operating Temperature Range	-40 to +75	°C
Storage Temperature Range	-40 to +100	°C
Soldering Temperature	Reflow Soldering: 260°C for 10 sec. Hand Soldering: 350°C for 3 sec.	
Electric Static Discharge Threshold (HBM)	6000	V

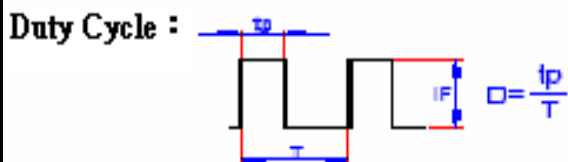
**Notes:**

- 1、 Proper current derating must be observed to maintain junction temperature below the maximum .
- 2、 All products not sensitive to ESD damage(6000 Volts by HBM condition).
- 3、 Be careful with a powered up current limited power supply, because of current spikes during power up and/or connection. Best practice is to connect the LED then turn up the voltage gradually. People building their own power supplies should design for minimum current spikes during power up and connection.
- 4、 For best results the customer needs to provide proper control of the thermal path ,protect against electrical overstress conditions, and ensure that Ledtech emitters are properly attached to the mcpcb/heat sink.
- 5、 It is strongly recommended that the temperature of lead does not exceed 55°C.
- 6、 It is strongly recommended to apply on electrically isolated heat conducting film between the slug and contact surfaces.

Electrical and Optical Characteristics :

Parameter		Symbol	Condition	Values			Units
				Min.	Typ.	Max.	
Luminous Flux	FULL	Φ_v	IF=700mA		210		lm
	Rank L1			180		200	
	Rank L2			200		240	
Forward voltage	Rank V01	VF	IF=700mA	2.9	--	3.1	V
	Rank V02			3.1	--	3.3	
	Rank V03			3.3	--	3.5	
	Rank V04			3.5	--	3.7	
	Rank V05			3.7	--	3.9	
Correlated Colour Temperature		CCT	IF=700mA		6250		K
CIE Chromaticity Coordinates: X Axis		X	IF=700mA		0.3175		
CIE Chromaticity Coordinates: Y Axis		Y	IF=700mA		0.3283		
Reverse Current		I_R	$V_r=5V$	--	--	50	μA
Viewing angle		$2\theta_{1/2}$	IF=700mA	--	130	--	Deg.
Thermal Resistance Junction to Case		$R_{\theta_{J-C}}$	IF=700mA	--	15	--	$^{\circ}C/W$

Notes :

1. The datas tested by IS tester.
2. Customer's special requirements are also welcome.

Typical Electrical/Optical Characteristic Curves

(25°C Ambient Temperature Unless Otherwise Noted)

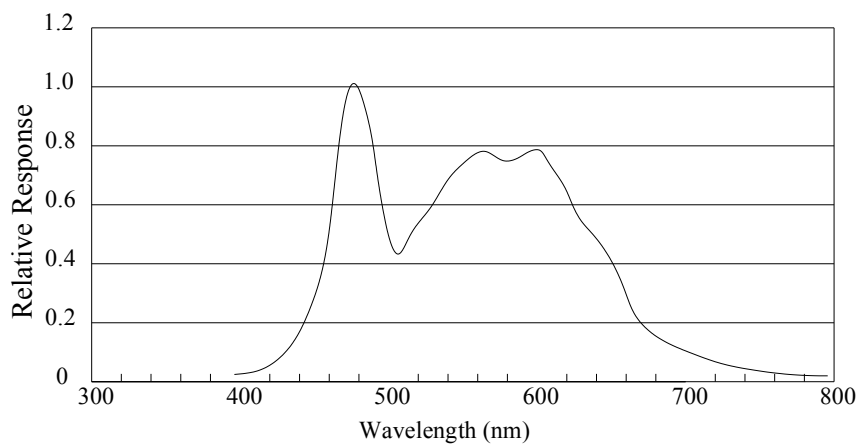
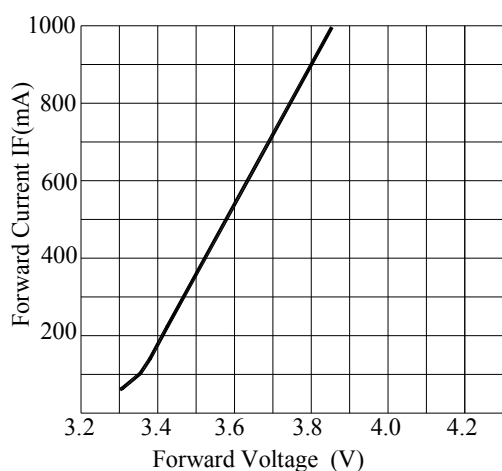
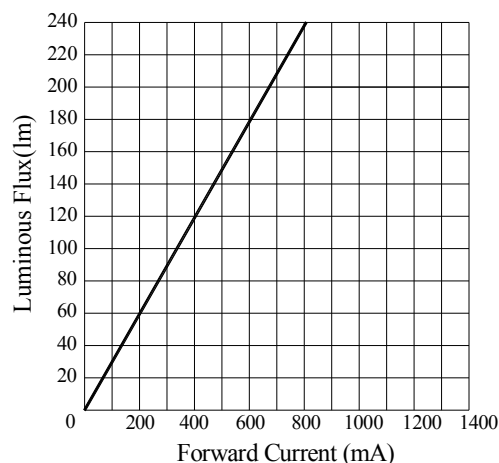

Fig.1 WHITE LED Spectrum VS. WAVELENGTH



Forward Current VS. Applied Voltage



Forward Current VS. Luminous Flux

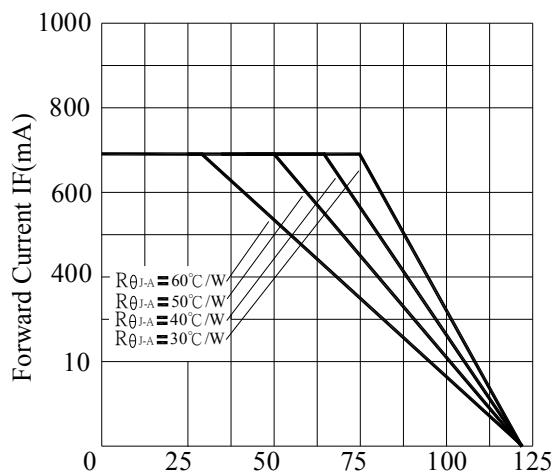

Ambient Temperature VS. Forward Current

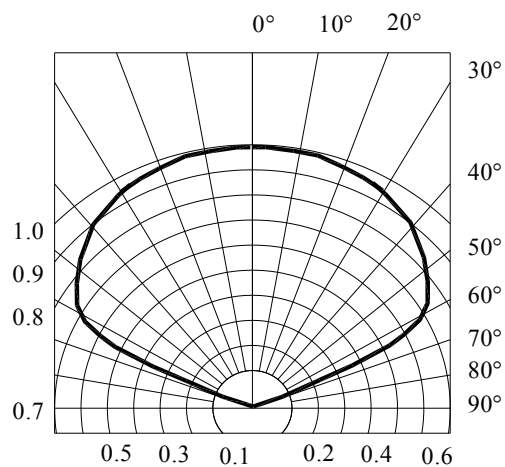

Radiation Diagram

Chromaticity Coordinates Specifications for Bin Grading:

COLOR RANKS (IF=700mA, Ta=25°C)

BIN	RANK					BIN	RANK				
WC6	X	0.3264	0.3327	0.3324	0.3268	WC7	X	0.3268	0.3324	0.3324	0.3272
	Y	0.3551	0.3650	0.3519	0.3430		Y	0.3430	0.3519	0.3388	0.3305
WD6	X	0.3210	0.3264	0.3268	0.3218	WD7	X	0.3218	0.3268	0.3272	0.3227
	Y	0.3468	0.3551	0.3430	0.3353		Y	0.3353	0.3430	0.3305	0.3233
WE6	X	0.3164	0.3210	0.3218	0.3175	WE7	X	0.3175	0.3218	0.3227	0.3186
	Y	0.3395	0.3468	0.3353	0.3283		Y	0.3283	0.3353	0.3233	0.3169
WF6	X	0.3122	0.3164	0.3175	0.3136	WF7	X	0.3136	0.3175	0.3186	0.3151
	Y	0.3331	0.3395	0.3283	0.3223		Y	0.3223	0.3283	0.3169	0.3114
WG6	X	0.3085	0.3122	0.3136	0.310	WG7	X	0.3103	0.3136	0.3151	0.3120
	Y	0.3273	0.3331	0.3223	0.3170		Y	0.3170	0.3223	0.3114	0.3064
WH6	X	0.3052	0.3085	0.3103	0.3070	WH7	X	0.3070	0.3103	0.3120	0.3091
	Y	0.3222	0.3273	0.3170	0.3118		Y	0.3118	0.3170	0.3064	0.3019

Note: X, Y Tolerance each Bin limit is ± 0.01 .

Chromaticity Coordinates & Bin grading diagram:

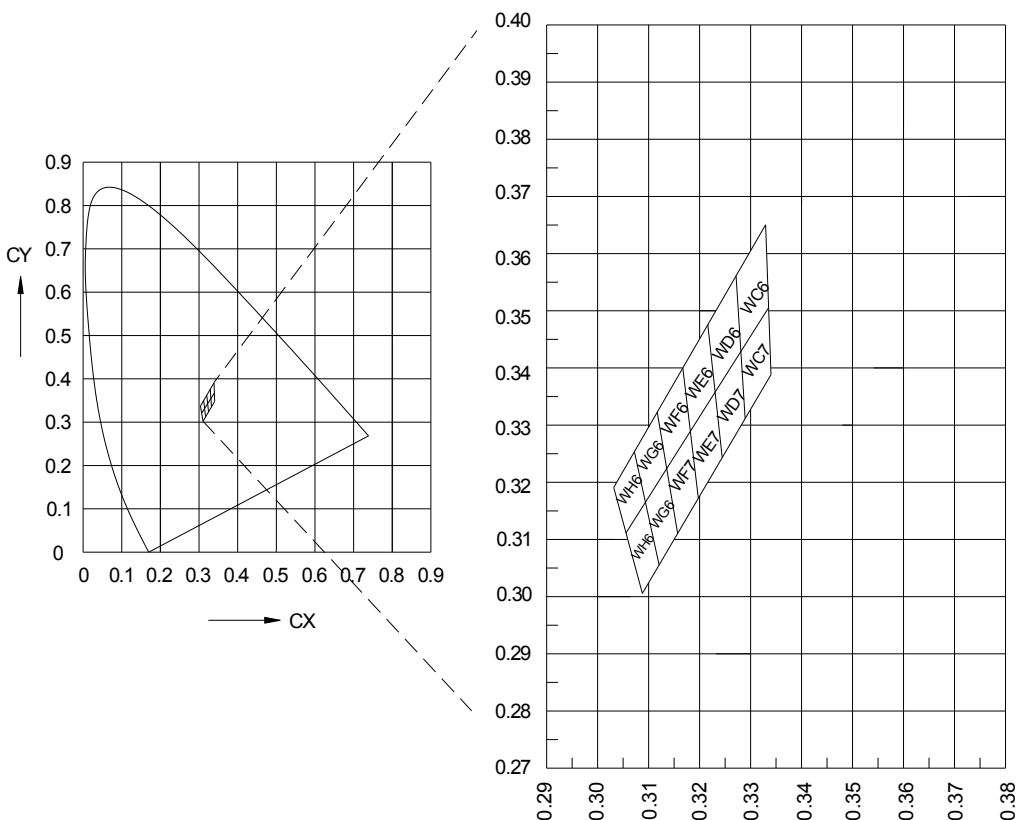

PRECAUTION IN USE

Storage

Recommended storage environment

Temperature: 5°C ~ 30°C (41°F ~ 86°F)

Humidity: 60% RH Max.

Moisture measures: Please refer to Moisture-sensitive label on reels package bags.

If unused LEDs remain, they should be stored in moisture proof packages, such as sealed container with packages of moisture absorbent material (silica gel). It is also recommended to return the LEDs to the original moisture proof bag and to reseal the moisture proof bag again.

Fold the opened bag firmly and keep in dry environment.

Soldering

	Reflow Soldering		Hand Soldering	
	Lead Solder	Lead – free Solder		
Pre-heat	120~150°C	180~200°C	Temperature	350°C Max.
Pre-heat time	120sec. Max.	120sec. Max.	Soldering time	3sec. Max. (one time only)
Peak temperature	240°C Max.	260°C Max.		
Soldering time	10sec. Max.	10sec. Max.		
Condition	refer to Temperature- profile 1	refer to Temperature- profile 2		

*After reflow soldering rapid cooling should be avoided.

[Temperature-profile (Surface of circuit board)]

Use the conditions shown to the under figure.

< 1 : Lead Solder >

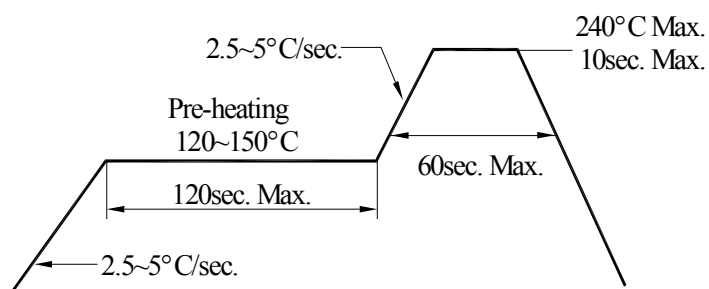

< 2 : Lead-free Solder >

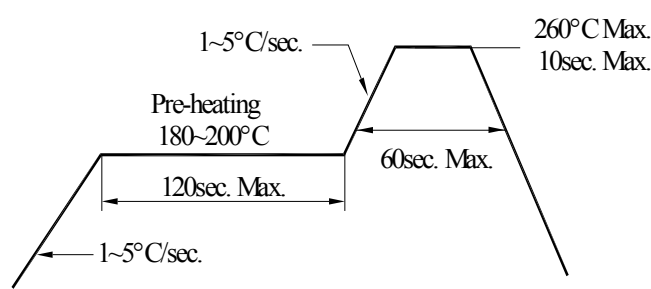

Recommended soldering pad design

Use the following conditions shown in the figure.

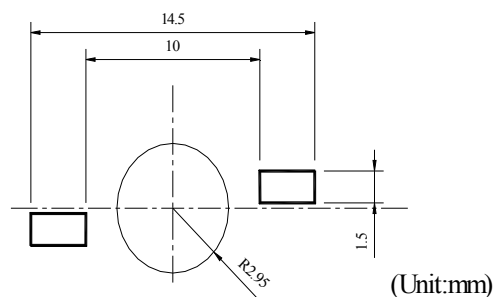

Handling of Silicone Resin LEDs

Handling Indications

During processing, mechanical stress on the surface should be minimized as much as possible. Sharp objects of all types should not be used to pierce the sealing compound

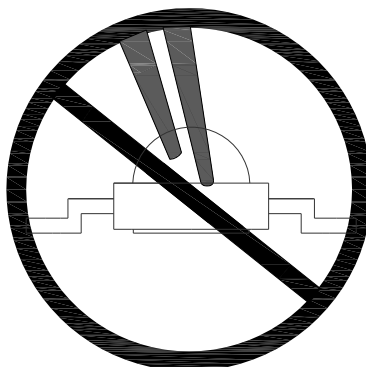

Figure 1

In general, LEDs should only be handled from the side. By the way, this also applies to LEDs without a silicone sealant, since the surface can also become scratched.

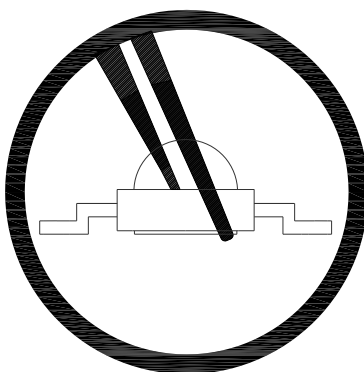

Figure 2

When populating boards in SMT production, there are basically no restrictions regarding the form of the pick and place nozzle, except that mechanical pressure on the surface of the resin must be prevented.

This is assured by choosing a pick and place nozzle which is larger than the LED's reflector area.

ENCASED TYPE

TUBE:
QUANTITY: 50 PCS

PART NO :LTXXXX-XX
LOT :XXXXXXXXXX QTY'S :XXPCS BIN CODE:XX-XX

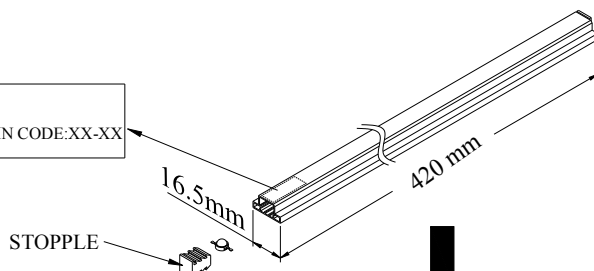

INNER BOX
QUANTITY: 10 TUBES
TOTAL: 5,00 PCS

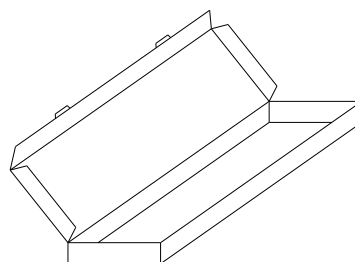

MIDDLE BOX
QUANTITY: 10 BOXES
TOTAL: 5,000 PCS

PART NO.	LXXXXX-XX-XX				
LOT NO.	XXXXXXXXXX				
BIN CODE	Xx X	Xx X	Xx X	Xx X	TOTAL
QUANTITY	PCS	PCS	PCS	PCS	PCS
DATE	XXXX, XX, XX				

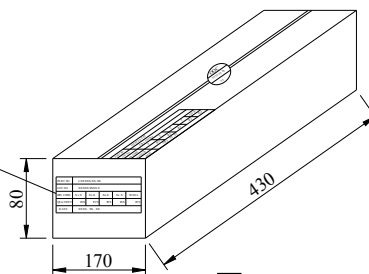

OUTER CARTON
QUANTITY: 2 BOXES
TOTAL: 10,000 PCS

C/T NO. 箱 號	XX
PART NO. 料 號	LXXXXX-XX-XX
QUANTITY 數 量	PCS
N.W. 淨 重	KGS
G.W. 毛 重	KGS
REMARK 備 註	

