



LEDTECH ELECTRONICS CORP.

NANYA ROAD, MUGANG ZHAOQING  
CITY GUANGDONG CHINA.

TEL: 86-758-2875541, 2870651, 2877464, 2876185, 2877017

FAX: 86-758-2878014

[Http://www.ledtech.com.tw](http://www.ledtech.com.tw)

# SPECIFICATION

*PART NO. : LP5K23-3D-UAK4-S25*

*3.2 x 2.8mm SMD TYPE*



Approved by	Checked by	Prepared by
<i>Tung</i>	<i>Lian</i>	<i>Yu Fang</i>



**Package Dimensions**

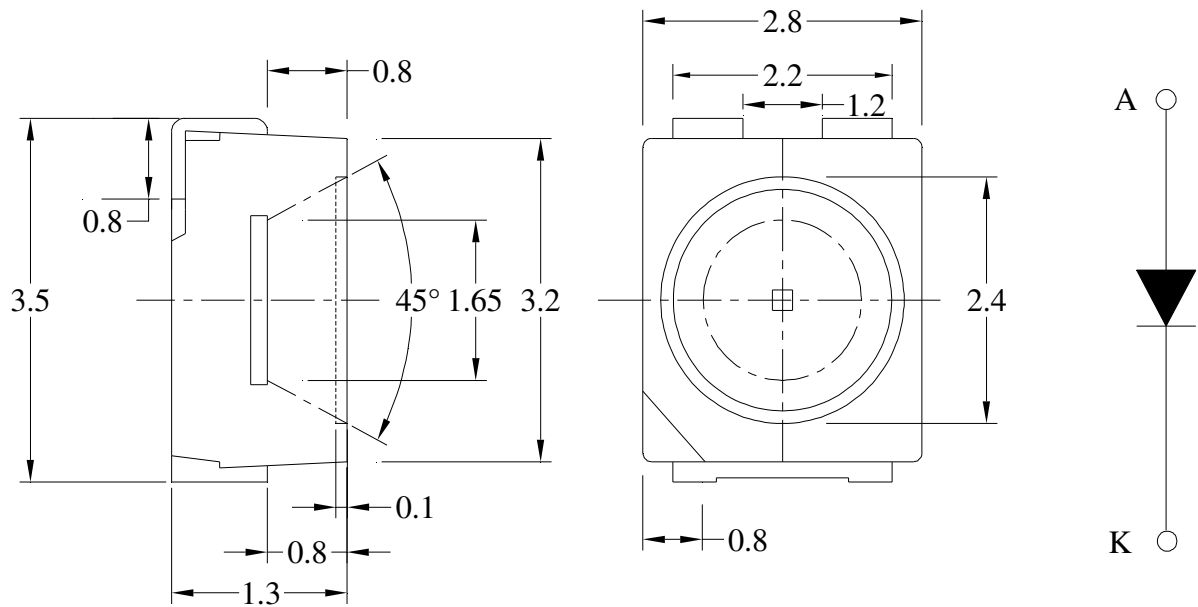

**Notes:**

1. All dimensions are in mm.
2. Tolerance is  $\pm 0.25$ mm unless otherwise noted.

**Description**

Part No.	LED Chip		Lens Color
	Material	Emitting Color	
LP5K23-3D-UAK4-S25	InGaN/Al <sub>2</sub> O <sub>3</sub>	True Green	Water Clear

**Absolute Maximum Ratings at Ta=25°C**

Parameter	Symbol	Rating	Unit
Led Junction Temperature	Tj	110	°C
Power Dissipation	PD	570	mW
Reverse Voltage	VR	5	V
D.C. Forward Current	If	150	mA
Peak Current(1/10Duty Cycle,0.1ms Pulse Width.)	If(Peak)	300	mA
Operating Temperature Range	Topr.	-40 to +75	°C
Storage Temperature Range	Tstg.	-40 to +105	°C
Soldering Temperature	Tsld.	Reflow Soldering: 260°C for 10 sec. Hand Soldering: 350°C for 3 sec.	
Electric Static Discharge Threshold (HBM)	ESD	6000	V
Thermal Resistance Junction toBoard(Heat Sink)	Rθ <sub>J-B</sub>	31	°C/W

**Electrical and Optical Characteristics:**

Parameter	Symbol	Condition	Min.	Typ.	Max.	Unit
Luminous Flux ※	Φ <sub>v</sub>	If=150mA	12.0	16.1		lm
Forward Voltage	V <sub>f</sub>	If=150mA		3.2	3.8	V
Peak Wavelength	λ <sub>p</sub>	If=150mA		---		nm
Dominant Wavelength	λ <sub>d</sub>	If=150mA		525		nm
Reverse Current	I <sub>r</sub>	V <sub>r</sub> =5V			50	μA
Viewing Angle	2θ 1/2	If=150mA		120		deg
Spectrum Line Halfwidth	Δλ	If=150mA		35		nm

Notes: ※Luminous Flux is converted from Luminous Intensity.

1.The datas tested by IS tester.

2. Customer's special requirements are also welcome.

**Typical Electrical/Optical Characteristic Curves**

**(25°C Ambient Temperature Unless Otherwise Noted)**

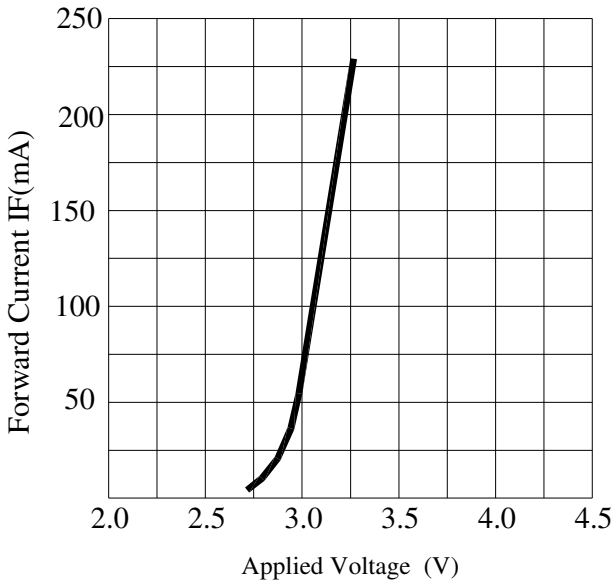

Forward Current VS. Applied Voltage

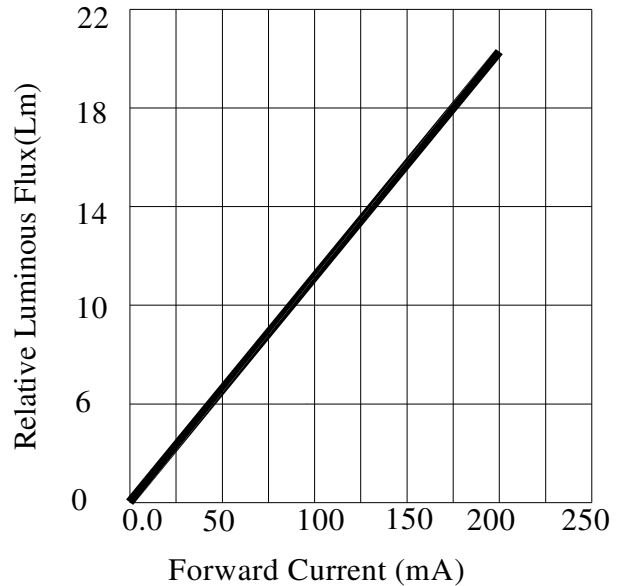

Forward Current VS. Luminous Intensity

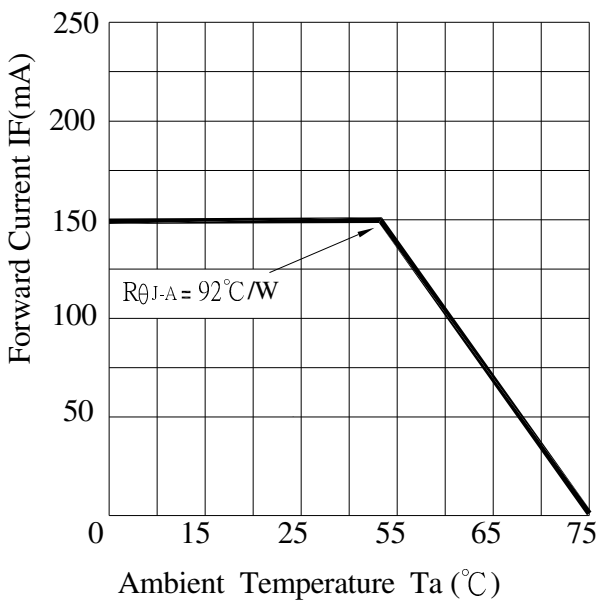

Ambient Temperature VS. Forward Current

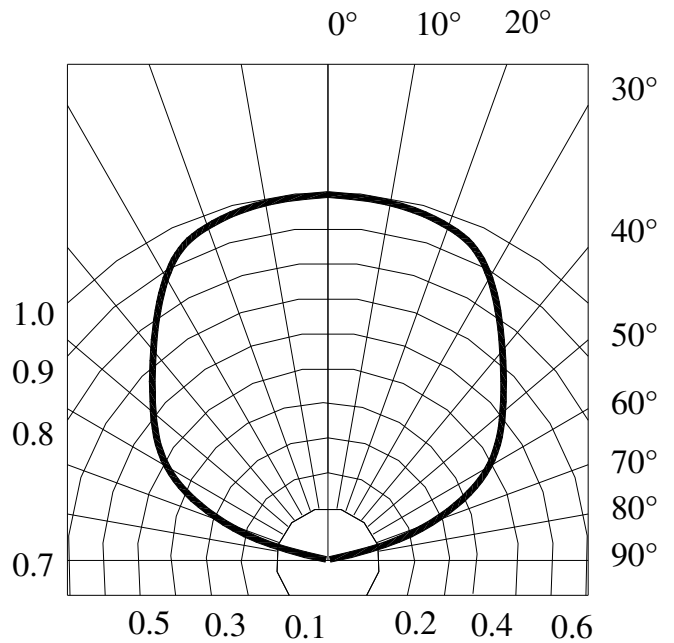

Radiation Diagram

**PRECAUTION IN USE**

**Storage**

**Recommended storage environment**

**Temperature:** 5°C ~ 30°C (41°F ~ 86°F)

**Humidity:** 60% RH Max.

**Use within 7 days after opening of sealed vapor/ESD barrier bags.**

**If the moisture absorbent material (silica gel) has faded away or the LEDs have exceeded the storage time, baking treatment should be performed using the following conditions.**

**Baking treatment : 60±5°C for 24 hours.**

**Fold the opened bag firmly and keep in dry environment.**

**Soldering**

	Reflow Soldering		Hand Soldering	
	Lead Solder	Lead – free Solder		
Pre-heat	120~150°C	180~200°C	Temperature	350°C Max.
Pre-heat time	120sec. Max.	120sec. Max.	Soldering time	3sec. Max. (one time only)
Peak temperature	240°C Max.	260°C Max.		
Soldering time	10sec. Max.	10sec. Max.		
Condition	refer to Temperature- profile 1	refer to Temperature- profile 2		

\*After reflow soldering rapid cooling should be avoided.

[Temperature-profile (Surface of circuit board)]

Use the conditions shown to the under figure.

< 1 : Lead Solder >

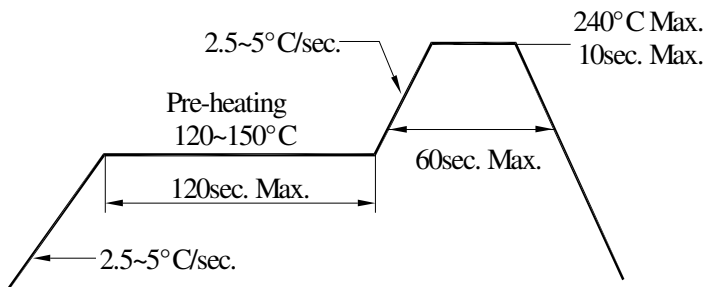

< 2 : Lead-free Solder >

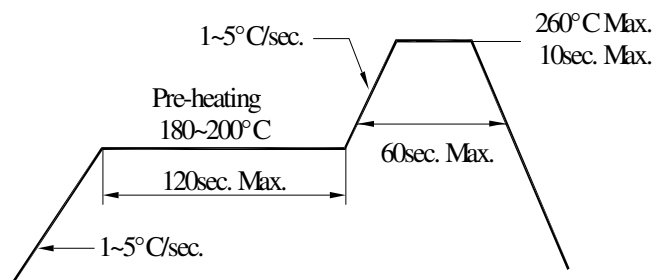

[ Recommended soldering pad design ]

Use the following conditions shown in the figure.

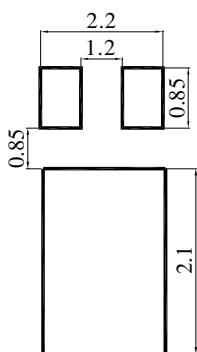

## Handling of Silicone Resin LEDs

### Handling Indications

During processing, mechanical stress on the surface should be minimized as much as possible. Sharp objects of all types should not be used to pierce the sealing compound

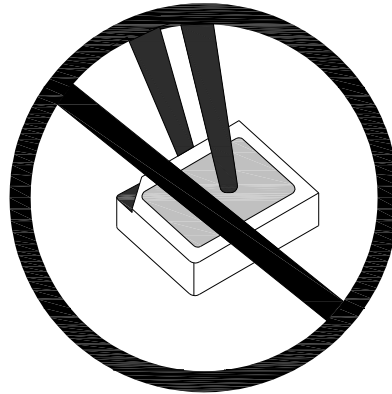

**Figure 1**

In general, LEDs should only be handled from the side. By the way, this also applies to LEDs without a silicone sealant, since the surface can also become scratched.

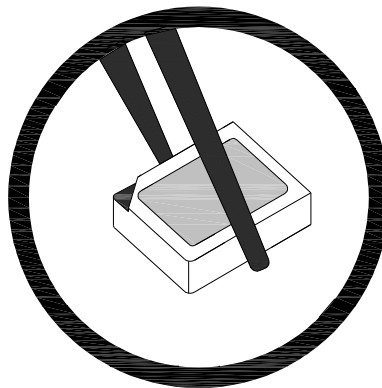

**Figure 2**

When populating boards in SMT production, there are basically no restrictions regarding the form of the pick and place nozzle, except that mechanical pressure on the surface of the resin must be prevented.

This is assured by choosing a pick and place nozzle which is larger than the LED's reflector area.



## Packing

REEL

QUANTITY: 2,000 PCS

LEDTECH ELECTRONICS CORP.  
PART NO :LTXXXX-XX  
QTY : PCS  
LOT NO :XXXXXXXXXX  
DATE :  
BIN CODE:

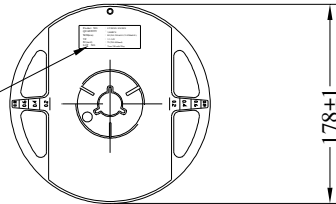

BAG

QUANTITY: 2,000 PCS

LEDTECH ELECTRONICS CORP.  
PART NO :LTXXXX-XX  
QTY : PCS  
LOT NO :XXXXXXXXXX  
DATE :  
BIN CODE:

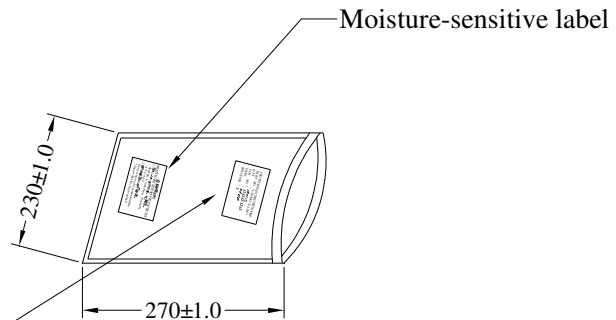

INSIDE BOX

QUANTITY: 4 BAGS

TOTAL: 8,000 PCS

LEDTECH ELECTRONICS CORP.  
PART NO :LTXXXX-XX  
QTY : PCS  
LOT NO :XXXXXXXXXX  
DATE :  
BIN CODE:

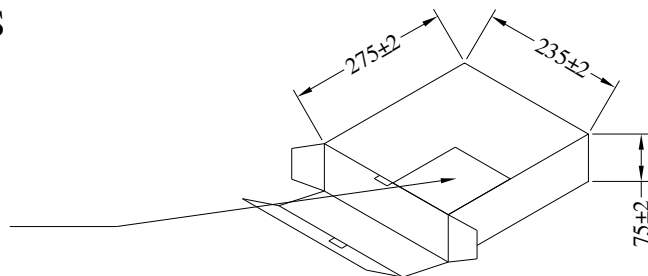

### Notes:

- 1.All dimensions are in mm, tolerance is $\pm 2.0$ mm unless otherwise noted.
- 2.Specifications are subject to change without notice.