



Model Number

VMA-2+P/Z2-1M-PUR

Valve connector cordset, Form A,
2+PE, Z diode, PUR cable

Features

- Valve connector according EN 175301-803 A/ISO 4400 (previously DIN 43650)
- Z diode as a protective circuit
- Built-in LED, as operating and function indicator
- freely selectable cable models due to bridged protective earth
- Flame resistant cable
- Halogen-free
- UL Recognized Component

Dimensions

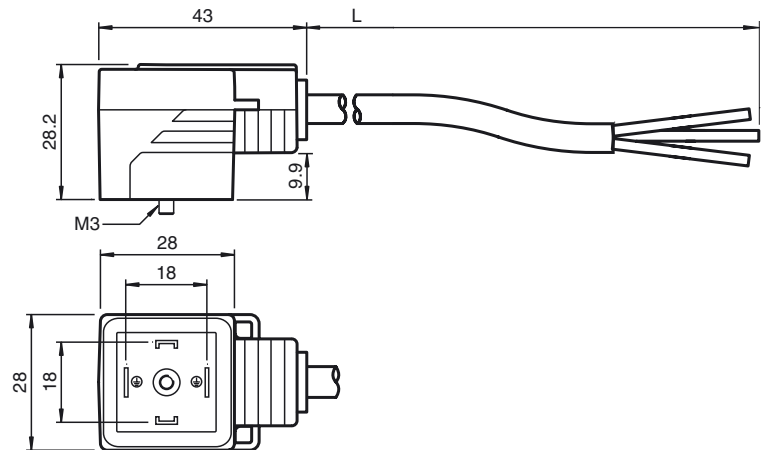

Technical data

General specifications

Number of pins	2 + PE
Connection 1	Valve connector DIN
Construction type 1	right angle
Connection 2	cabl end

Indicators/operating means

LED yellow	Functional display
------------	--------------------

Electrical specifications

Operating voltage	U_B	24 V AC/DC
Operating current		max. 4 A
Volume resistance		< 5 m Ω

Ambient conditions

Ambient temperature	Body: -20 ... 85 °C (-4 ... 185 °F) cable, flexing: -20 ... 80 °C (-4 ... 176 °F) cable, fixed: -40 ... 80 °C (-40 ... 176 °F)
Pollution Degree	3

Mechanical specifications

Protection degree	IP65/IP67	
Connection	Valve connector Form A	
Material		
Contacts	CuSn	
Contact surface	Sn	
Body	TPU, black	
Cable	PUR	
Core insulation	PP	
Cable		
Sheath diameter	\varnothing 4.5 mm	
Bending radius	> 50 mm > 22.5 mm, fixed	
Color	dark grey (RAL 7021)	
Cores	(2 + 1) x 0.5 mm ² ; 20 AWG	
Conductor construction	28 x 0.15 mm \varnothing	
Length	L	1 m

Approvals and certificates

UL approval	cURus AWM 20549 (cable)
-------------	-------------------------

Electrical connection

