



Model Number

V1-G-50M-PUR-ABG-V1-W

Connecting cable, M12 to M12, PUR cable 4-pin, shielded

Features

- Knurled nut suitable for tool assembly
- Immunity to vibration, with mechanical latching
- Shield attached to coupling nut
- Gold-plated and machined contacts
- Protection degree IP67 / IP68 / IP69K
- Halogen-free

Dimensions

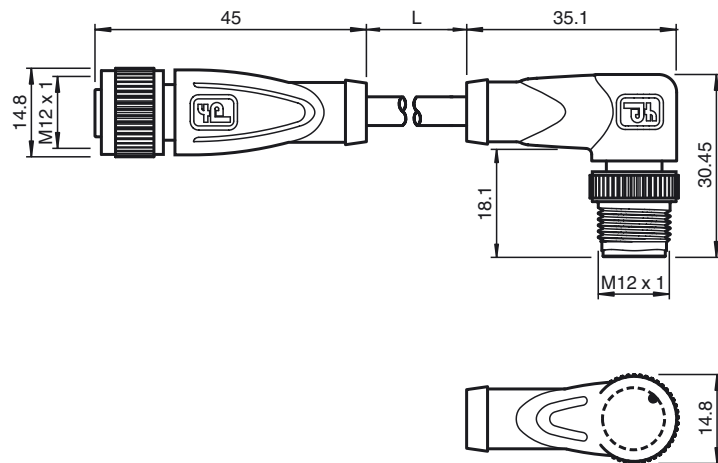

Technical data

General specifications

Number of pins	4 + shield
Connection 1	socket
Construction type 1	straight
Threading 1	M12
Connection 2	Male connector
Construction type 2	right angle
Threading 2	M12

Electrical specifications

Operating voltage	U_B	max. 250 V AC/DC
Operating current		max. 4 A
Volume resistance		< 5 m Ω

Ambient conditions

Ambient temperature	-40 ... 90 °C (-40 ... 194 °F) cable, flexing: -25 ... 80 °C (-13 ... 176 °F) cable, fixed: -25 ... 80 °C (-13 ... 176 °F)
Pollution Degree	3

Mechanical specifications

Contact elements	spring-loaded contact socket
Pin diameter	1 mm
Protection degree	IP67 / IP68 / IP69k
Material	
Contacts	CuSn / Au
Contact surface	Au
Body	TPU, black
Cable	PUR
Slotted nut	Diecast zinc
Sleeve connector	Diecast zinc
Core insulation	PP
Cable	fine-strand, flexible
Sheath diameter	\varnothing 4.8 mm
Bending radius	> 10 x cable diameter, moving 5 x cable diameter, single bend
Color	grey
Cores	4 x 0.34 mm ²
Conductor construction	19 x 0.15 mm \varnothing
Shield	grid covering 85 %
Length	L 50 m
Flammability	
Contact material	HB
Housing	V-2

Compliance with standards and directives

Standard conformity

Electrical connection

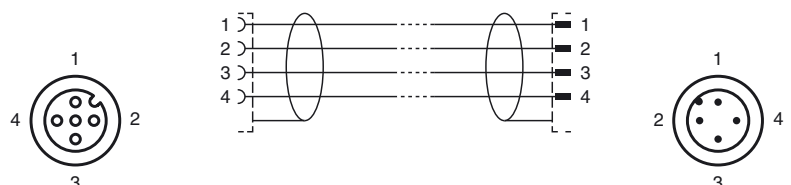



Protection degree	EN 60529:2000
Standards	IEC 61076-2-101:2008
Flammability	Grip: UL 94

Release date: 2013-08-14 13:16 Date of issue: 2013-08-14 198716_eng.xml