

# BTA202X series D and E

## 2 A Three-quadrant triacs high commutation

Rev. 01 — 7 February 2008

Product data sheet

## 1. Product profile

---

### 1.1 General description

Passivated high commutation triacs in a SOT186A 'full pack' plastic package. These triacs balance the requirements of commutation performance and gate sensitivity. The 'sensitive' gate E series and 'logic level' D series are intended for interfacing with low-power drivers, including microcontrollers.

### 1.2 Features

- Sensitive gate
- Very high commutation performance maximized at each gate sensitivity
- High immunity to dV/dt
- High isolation voltage

### 1.3 Applications



- Motor control
- Solenoid driver

### 1.4 Quick reference data

- $V_{\text{DRM}} \leq 600 \text{ V}$  (BTA202X-600D)
- $V_{\text{DRM}} \leq 600 \text{ V}$  (BTA202X-600E)
- $V_{\text{DRM}} \leq 800 \text{ V}$  (BTA202X-800D)
- $V_{\text{DRM}} \leq 800 \text{ V}$  (BTA202X-800E)
- $I_{\text{T(RMS)}} \leq 2 \text{ A}$
- $I_{\text{GT}} \leq 5 \text{ mA}$  (BTA202X-600D)
- $I_{\text{GT}} \leq 10 \text{ mA}$  (BTA202X-600E)
- $I_{\text{GT}} \leq 5 \text{ mA}$  (BTA202X-800D)
- $I_{\text{GT}} \leq 10 \text{ mA}$  (BTA202X-800E)

## 2. Pinning information

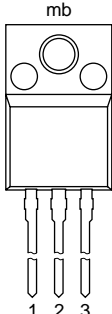
Table 1. Pinning

Pin	Description	Simplified outline	Graphic symbol
1	main terminal 1 (T1)		
2	main terminal 2 (T2)		
3	gate (G)		
mb	mounting base (isolated)		

**SOT186A (TO-220F)**

## 3. Ordering information

Table 2. Ordering information

Type number	Package		Version
	Name	Description	
BTA202X-600D	TO-220F	plastic single-ended package; isolated heatsink mounted; 1 mounting hole; 3-lead TO-220 'full pack'	SOT186A
BTA202X-600E			
BTA202X-800D			
BTA202X-800E			

## 4. Limiting values

Table 3. Limiting values

In accordance with the Absolute Maximum Rating System (IEC 60134).

Symbol	Parameter	Conditions	Min	Max	Unit
$V_{DRM}$	repetitive peak off-state voltage	BTA202X-600D; BTA202X-600E	[1]	600	V
		BTA202X-800D; BTA202X-800E	-	800	V
$I_{T(RMS)}$	RMS on-state current	full sine wave; $T_h \leq 110\text{ °C}$ ; see <a href="#">Figure 4</a> and <a href="#">5</a>	-	2	A
$I_{TSM}$	non-repetitive peak on-state current	full sine wave; $T_j = 25\text{ °C}$ prior to surge; see <a href="#">Figure 2</a> and <a href="#">3</a>	-	-	-
		$t = 20\text{ ms}$	-	14	A
		$t = 16.7\text{ ms}$	-	15.4	A
$I^2t$	$I^2t$ for fusing	$t_p = 10\text{ ms}$	-	0.98	A <sup>2</sup> s
$dl_T/dt$	rate of rise of on-state current	$I_{TM} = 1.5\text{ A}$ ; $I_G = 0.2\text{ A}$ ; $dl_G/dt = 0.2\text{ A}/\mu\text{s}$	-	100	A/ $\mu\text{s}$
$I_{GM}$	peak gate current		-	2	A
$P_{GM}$	peak gate power		-	5	W

**Table 3. Limiting values ...continued**

In accordance with the Absolute Maximum Rating System (IEC 60134).

Symbol	Parameter	Conditions	Min	Max	Unit
$P_{G(AV)}$	average gate power	over any 20 ms period	-	0.5	W
$T_{stg}$	storage temperature		-40	+150	°C
$T_j$	junction temperature		-	125	°C

[1] Although not recommended, off-state voltages up to 800 V may be applied without damage, but the triac may switch to the on-state. The rate of rise of current should not exceed 6 A/μs.

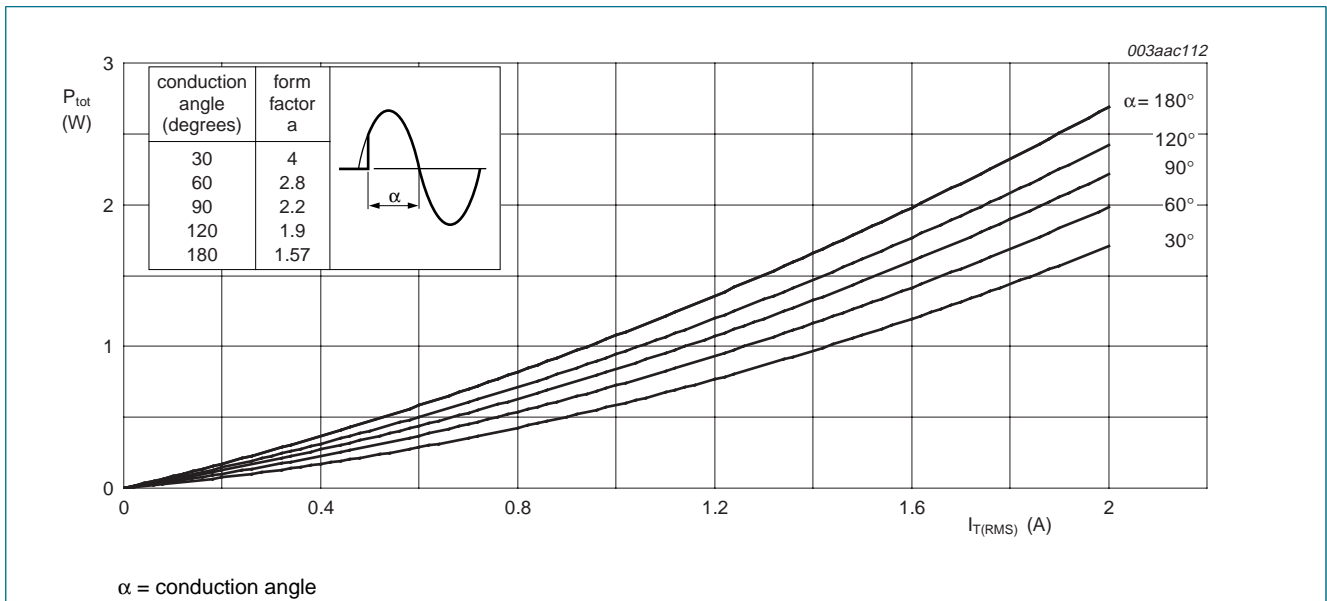

**Fig 1. Total power dissipation as a function of RMS on-state current; maximum values**

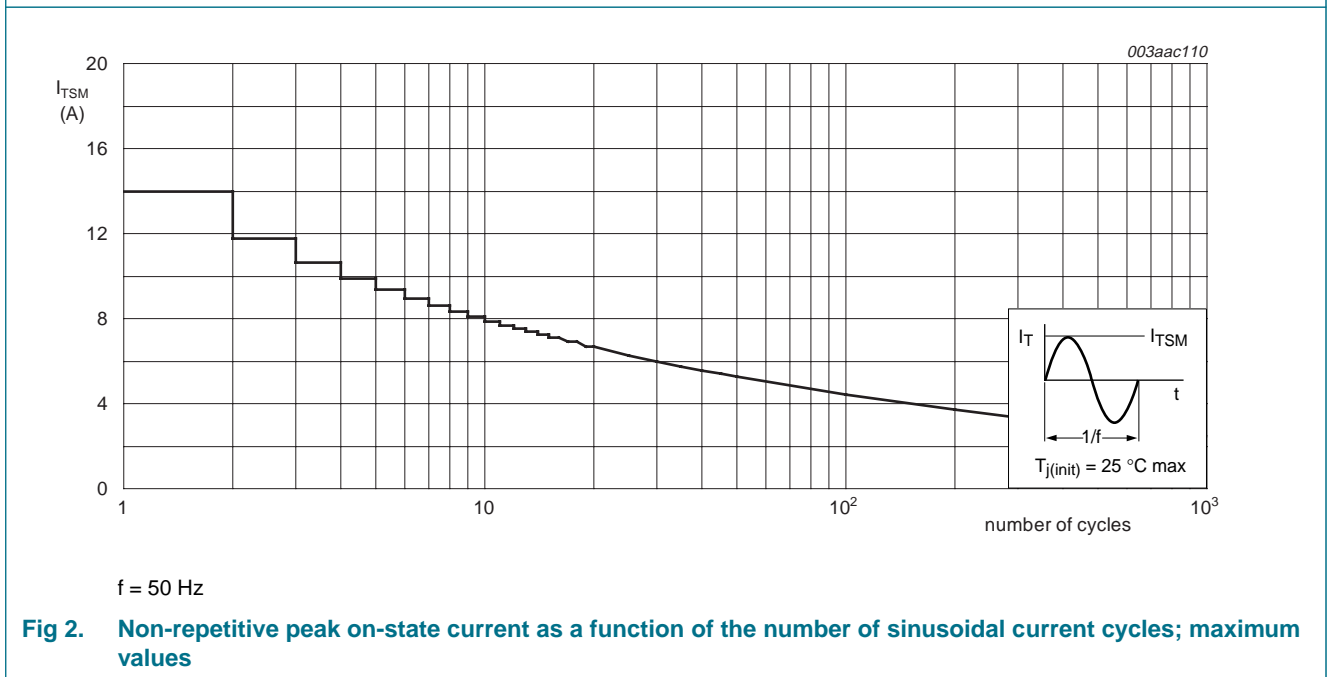

**Fig 2. Non-repetitive peak on-state current as a function of the number of sinusoidal current cycles; maximum values**

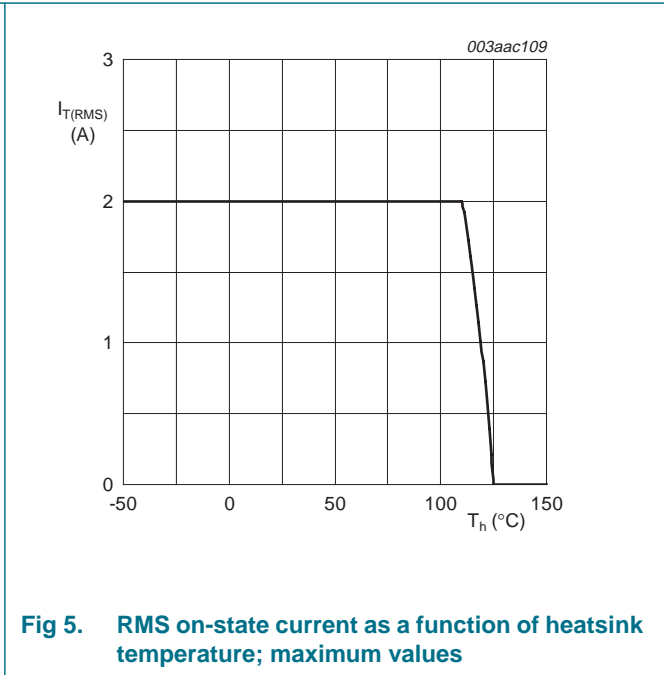
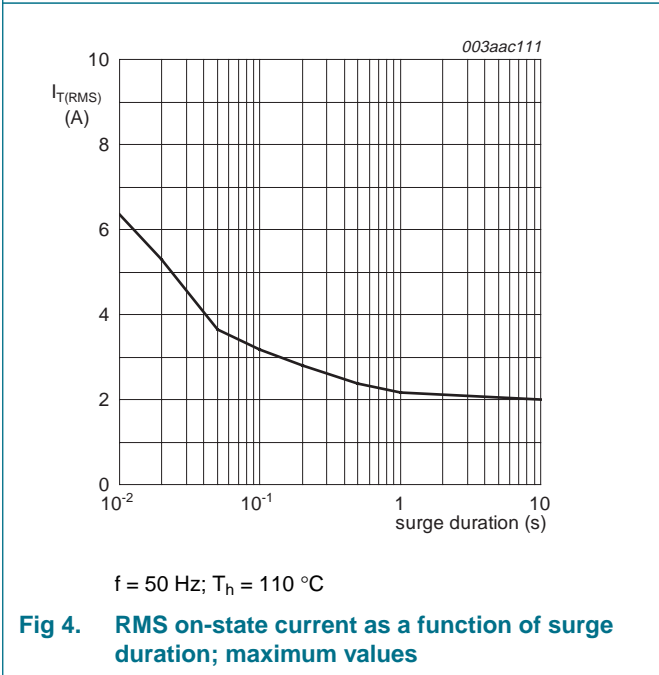
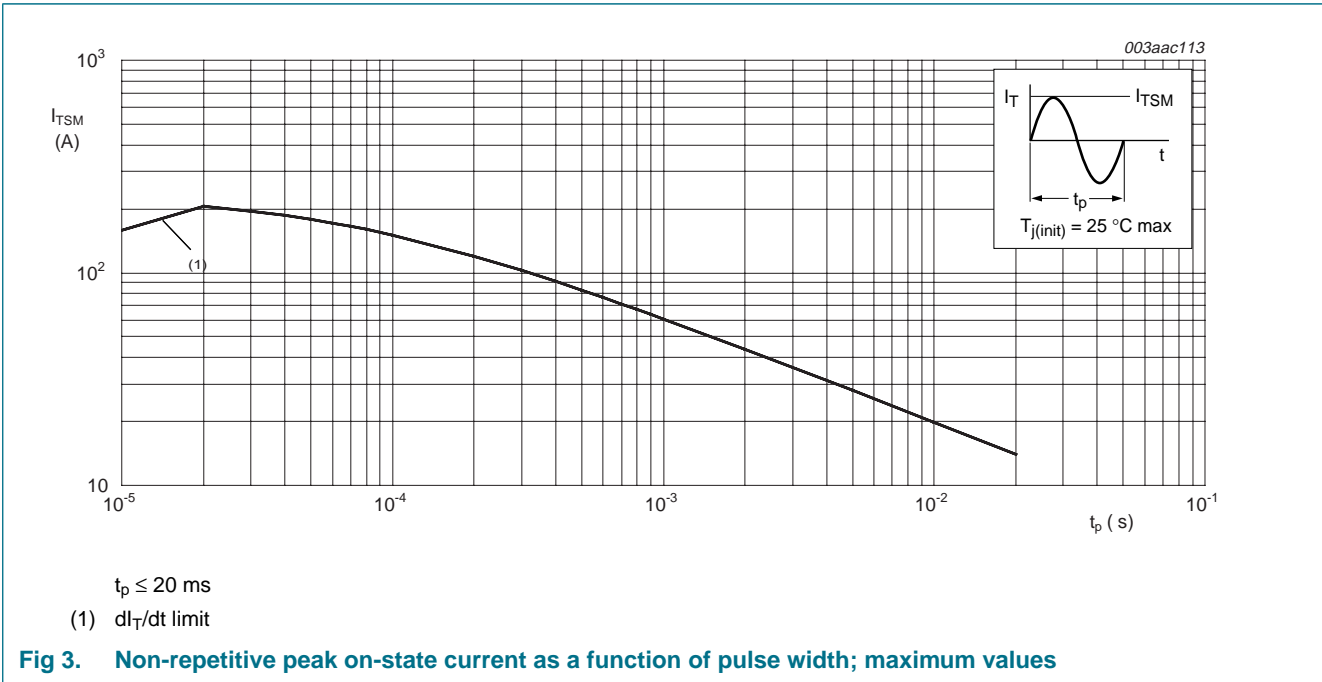

### 5. Thermal characteristics

Table 4. Thermal characteristics

Symbol	Parameter	Conditions	Min	Typ	Max	Unit
$R_{th(j-h)}$	thermal resistance from junction to heatsink	bidirectional; see <a href="#">Figure 6</a>	-	-	5.5	K/W
$R_{th(j-a)}$	thermal resistance from junction to ambient	in free air	-	55	-	K/W

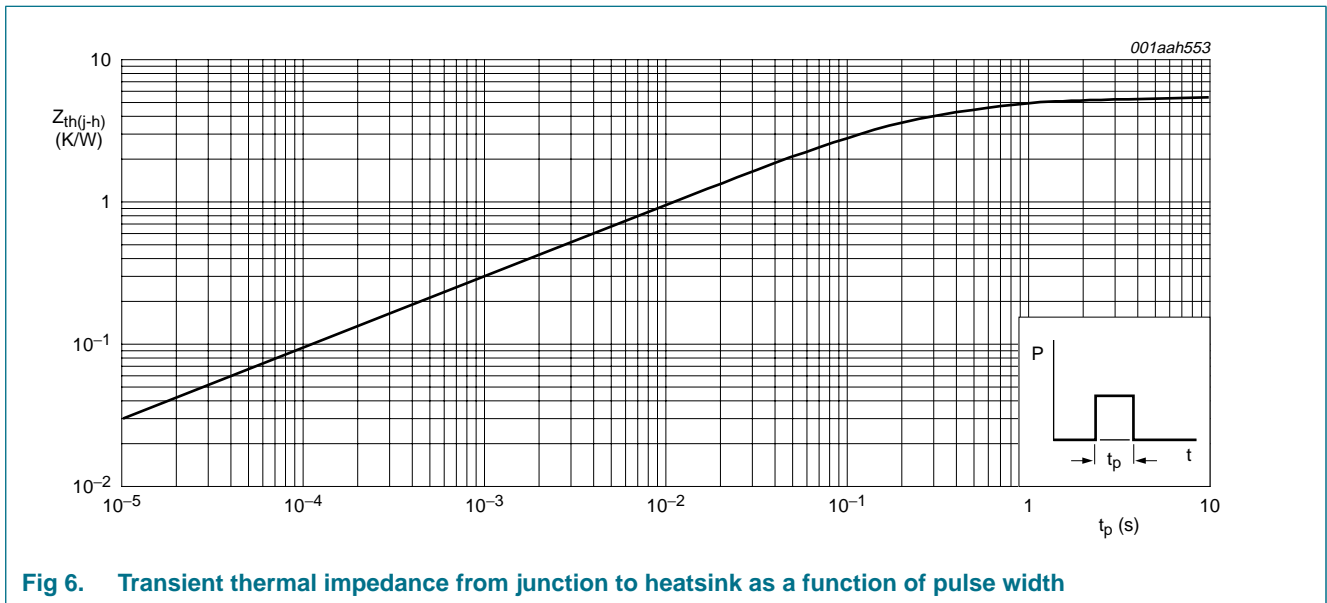

Fig 6. Transient thermal impedance from junction to heatsink as a function of pulse width

### 6. Isolation characteristics

Table 5. Isolation limiting values and characteristics

$T_h = 25\text{ }^\circ\text{C}$  unless otherwise specified.

Symbol	Parameter	Conditions	Min	Typ	Max	Unit
$V_{isol(RMS)}$	RMS isolation voltage	from all three terminals to external heatsink; $f = 50\text{ Hz}$ to $60\text{ Hz}$ ; sinusoidal waveform; $RH \leq 65\%$ ; clean and dust free	-	-	2500	V
$C_{isol}$	isolation capacitance	from pin 2 to external heatsink; $f = 1\text{ MHz}$	-	10	-	pF

## 7. Static characteristics

**Table 6. Static characteristics**

$T_j = 25\text{ °C}$  unless otherwise specified.

Symbol	Parameter	Conditions	BTA202X-600D BTA202X-800D			BTA202X-600E BTA202X-800E			Unit
			Min	Typ	Max	Min	Typ	Max	
$I_{GT}$	gate trigger current	$V_D = 12\text{ V}$ ; $I_T = 0.1\text{ A}$ ; see <a href="#">Figure 8</a>							
		T2+ G+	0.25	-	5	0.5	-	10	mA
		T2+ G-	0.25	-	5	0.5	-	10	mA
		T2- G-	0.25	-	5	0.5	-	10	mA
$I_L$	latching current	$V_D = 12\text{ V}$ ; $I_{GT} = 0.1\text{ A}$ ; see <a href="#">Figure 10</a>							
		T2+ G+	-	-	5	-	-	12	mA
		T2+ G-	-	-	10	-	-	20	mA
		T2- G-	-	-	5	-	-	12	mA
$I_H$	holding current	$V_D = 12\text{ V}$ ; $I_{GT} = 0.1\text{ A}$ ; see <a href="#">Figure 11</a>	-	-	5	-	-	12	mA
$V_T$	on-state voltage	$I_T = 3\text{ A}$ ; see <a href="#">Figure 9</a>	-	1.63	2	-	1.63	2	V
$V_{GT}$	gate trigger voltage	$V_D = 12\text{ V}$ ; $I_T = 0.1\text{ A}$ ; see <a href="#">Figure 7</a>	-	0.7	1.5	-	0.7	1.5	V
		$V_D = 400\text{ V}$ ; $I_T = 0.1\text{ A}$ ; $T_j = 125\text{ °C}$	0.2	0.3	-	0.2	0.3	-	V
$I_D$	off-state current	$V_D = V_{DRM(max)}$ ; $T_j = 125\text{ °C}$	-	0.1	0.5	-	0.1	0.5	mA

**8. Dynamic characteristics**

**Table 7. Dynamic characteristics**

Symbol	Parameter	Conditions	BTA202X-600D BTA202X-800D			BTA202X-600E BTA202X-800E			Unit
			Min	Typ	Max	Min	Typ	Max	
$dV_D/dt$	rate of rise of off-state voltage	$V_{DM} = 0.67 \times V_{DRM(max)}$ ; $T_j = 125\text{ }^\circ\text{C}$ ; exponential waveform; $R_{(G-MT1)} = 220\ \Omega$	-	350	-	-	500	-	V/ $\mu\text{s}$
$dl_{com}/dt$	rate of change of commutating current	$V_{DM} = 400\text{ V}$ ; $T_j = 125\text{ }^\circ\text{C}$ ; $I_{T(RMS)} = 2\text{ A}$ ; $dV_{com}/dt = 20\text{ V}/\mu\text{s}$ ; gate open circuit	1.0	-	-	2.0	-	-	A/ms
		$V_{DM} = 400\text{ V}$ ; $T_j = 125\text{ }^\circ\text{C}$ ; $I_{T(RMS)} = 2\text{ A}$ ; $dV_{com}/dt = 10\text{ V}/\mu\text{s}$ ; gate open circuit	1.2	-	-	2.3	-	-	A/ms
$t_{gt}$	gate-controlled turn-on time	$I_{TM} = 20\text{ A}$ ; $V_D = V_{DRM(max)}$ ; $I_G = 0.1\text{ A}$ ; $dl_G/dt = 5\text{ A}/\mu\text{s}$	-	2	-	-	2	-	$\mu\text{s}$

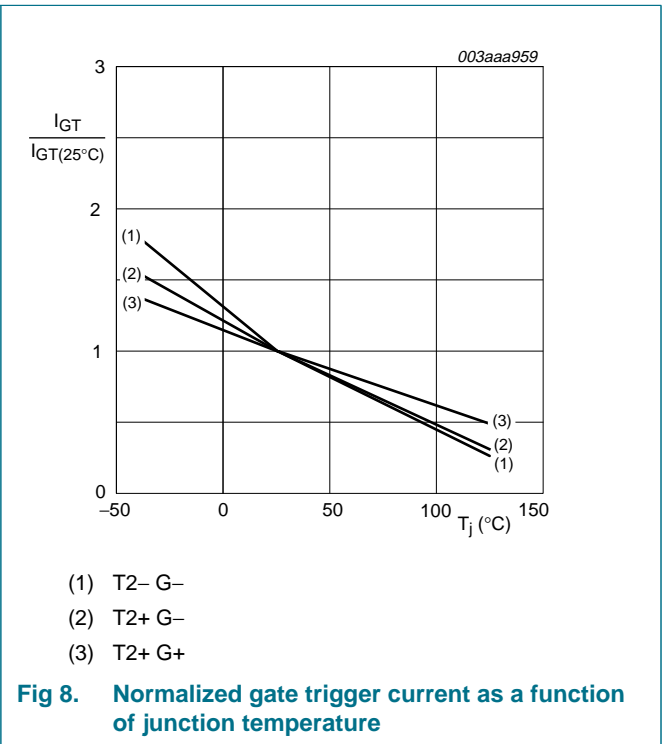
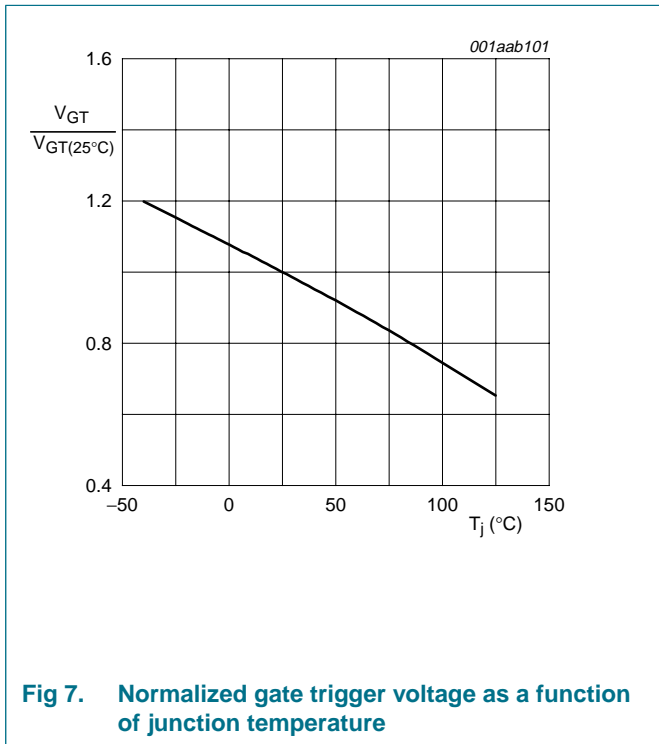

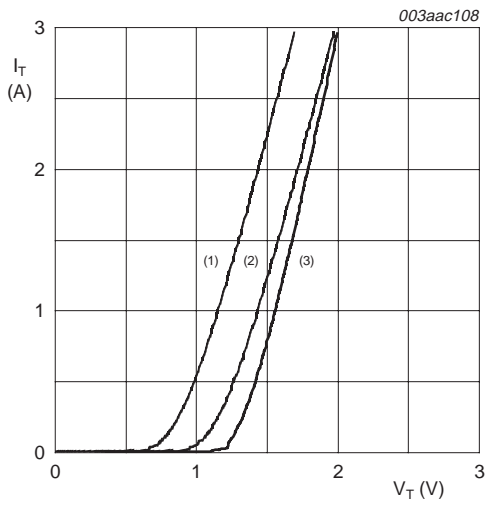

$V_o = 0.9\text{ V}$   
 $R_s = 0.267\ \Omega$   
 (1)  $T_j = 125\text{ }^\circ\text{C}$ ; typical values  
 (2)  $T_j = 125\text{ }^\circ\text{C}$ ; maximum values  
 (3)  $T_j = 25\text{ }^\circ\text{C}$ ; maximum values

**Fig 9. On-state current as a function of on-state voltage**

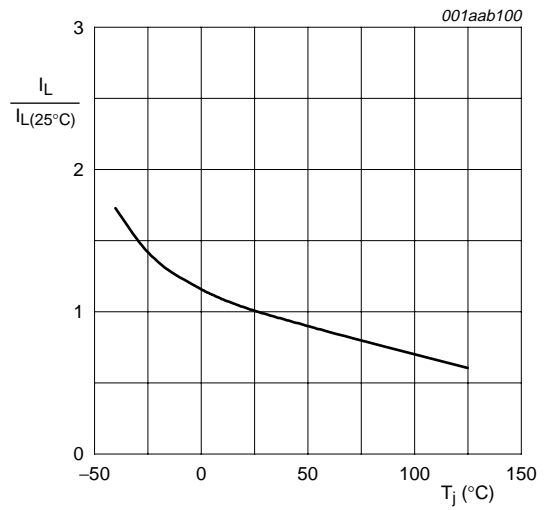

**Fig 10. Normalized latching current as a function of junction temperature**

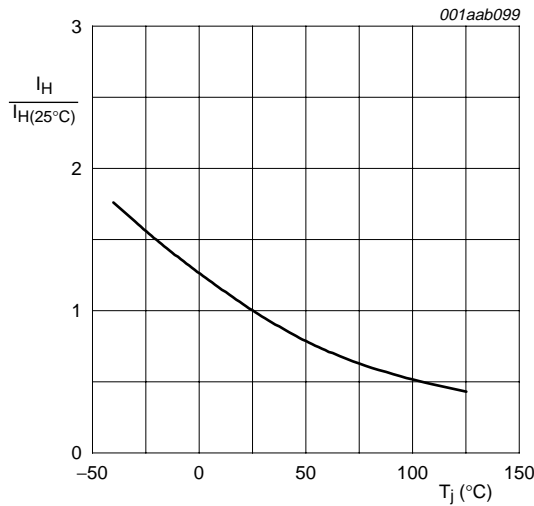

**Fig 11. Normalized holding current as a function of junction temperature**

## 9. Package information

Refer to mounting instructions for F-pack packages.

Epoxy meets UL94 V-0 at 3.175 mm.

10. Package outline

Plastic single-ended package; isolated heatsink mounted;  
1 mounting hole; 3-lead TO-220 'full pack'

SOT186A

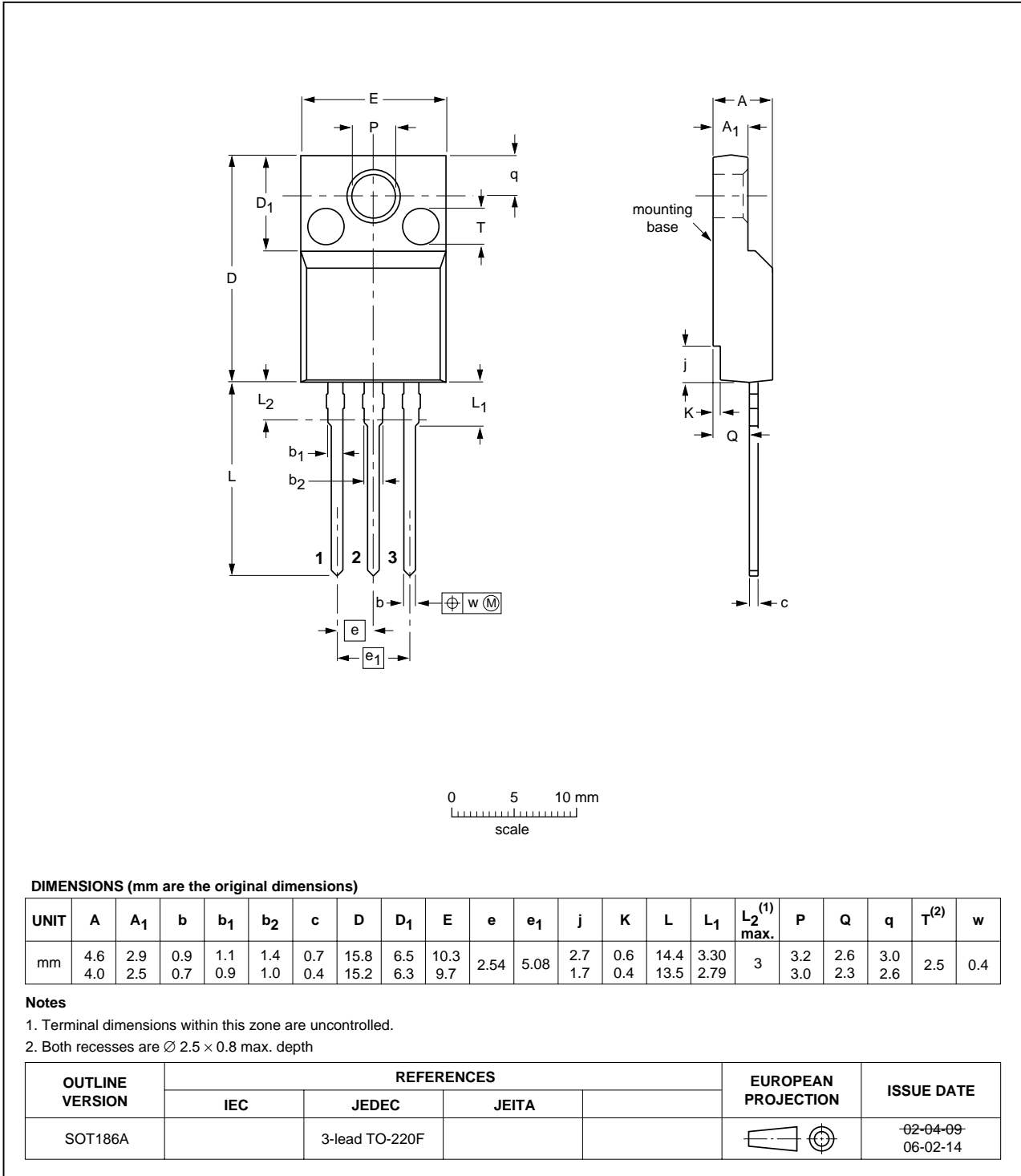

Fig 12. Package outline SOT186A (3-lead TO-220F)

## 11. Revision history

**Table 8. Revision history**

Document ID	Release date	Data sheet status	Change notice	Supersedes
BTA202X_SER_D_E_1	20080207	Product data sheet	-	-

## 12. Legal information

### 12.1 Data sheet status

Document status <sup>[1][2]</sup>	Product status <sup>[3]</sup>	Definition
Objective [short] data sheet	Development	This document contains data from the objective specification for product development.
Preliminary [short] data sheet	Qualification	This document contains data from the preliminary specification.
Product [short] data sheet	Production	This document contains the product specification.

[1] Please consult the most recently issued document before initiating or completing a design.

[2] The term 'short data sheet' is explained in section "Definitions".

[3] The product status of device(s) described in this document may have changed since this document was published and may differ in case of multiple devices. The latest product status information is available on the Internet at URL <http://www.nxp.com>.

### 12.2 Definitions

**Draft** — The document is a draft version only. The content is still under internal review and subject to formal approval, which may result in modifications or additions. NXP Semiconductors does not give any representations or warranties as to the accuracy or completeness of information included herein and shall have no liability for the consequences of use of such information.

**Short data sheet** — A short data sheet is an extract from a full data sheet with the same product type number(s) and title. A short data sheet is intended for quick reference only and should not be relied upon to contain detailed and full information. For detailed and full information see the relevant full data sheet, which is available on request via the local NXP Semiconductors sales office. In case of any inconsistency or conflict with the short data sheet, the full data sheet shall prevail.

### 12.3 Disclaimers

**Right to make changes** — NXP Semiconductors reserves the right to make changes to information published in this document, including without limitation specifications and product descriptions, at any time and without notice. This document supersedes and replaces all information supplied prior to the publication hereof.

**General** — Information in this document is believed to be accurate and reliable. However, NXP Semiconductors does not give any representations or warranties, expressed or implied, as to the accuracy or completeness of such information and shall have no liability for the consequences of use of such information.

**Suitability for use** — NXP Semiconductors products are not designed, authorized or warranted to be suitable for use in medical, military, aircraft, space or life support equipment, nor in applications where failure or malfunction of an NXP Semiconductors product can reasonably be expected to result in personal injury, death or severe property or environmental

damage. NXP Semiconductors accepts no liability for inclusion and/or use of NXP Semiconductors products in such equipment or applications and therefore such inclusion and/or use is at the customer's own risk.

**Applications** — Applications that are described herein for any of these products are for illustrative purposes only. NXP Semiconductors makes no representation or warranty that such applications will be suitable for the specified use without further testing or modification.

**Limiting values** — Stress above one or more limiting values (as defined in the Absolute Maximum Ratings System of IEC 60134) may cause permanent damage to the device. Limiting values are stress ratings only and operation of the device at these or any other conditions above those given in the Characteristics sections of this document is not implied. Exposure to limiting values for extended periods may affect device reliability.

**Terms and conditions of sale** — NXP Semiconductors products are sold subject to the general terms and conditions of commercial sale, as published at <http://www.nxp.com/profile/terms>, including those pertaining to warranty, intellectual property rights infringement and limitation of liability, unless explicitly otherwise agreed to in writing by NXP Semiconductors. In case of any inconsistency or conflict between information in this document and such terms and conditions, the latter will prevail.

**No offer to sell or license** — Nothing in this document may be interpreted or construed as an offer to sell products that is open for acceptance or the grant, conveyance or implication of any license under any copyrights, patents or other industrial or intellectual property rights.

**Quick reference data** — The Quick reference data is an extract of the product data given in the Limiting values and Characteristics sections of this document, and as such is not complete, exhaustive or legally binding.

### 12.4 Trademarks

Notice: All referenced brands, product names, service names and trademarks are the property of their respective owners.

## 13. Contact information

For more information, please visit: <http://www.nxp.com>

For sales office addresses, please send an email to: [salesaddresses@nxp.com](mailto:salesaddresses@nxp.com)

**14. Contents**

**1 Product profile . . . . . 1**

1.1 General description . . . . . 1

1.2 Features . . . . . 1

1.3 Applications . . . . . 1

1.4 Quick reference data . . . . . 1

**2 Pinning information . . . . . 2**

**3 Ordering information . . . . . 2**

**4 Limiting values . . . . . 2**

**5 Thermal characteristics . . . . . 5**

**6 Isolation characteristics . . . . . 5**

**7 Static characteristics . . . . . 6**

**8 Dynamic characteristics . . . . . 7**

**9 Package information . . . . . 8**

**10 Package outline . . . . . 9**

**11 Revision history . . . . . 10**

**12 Legal information . . . . . 11**

12.1 Data sheet status . . . . . 11

12.2 Definitions . . . . . 11

12.3 Disclaimers . . . . . 11

12.4 Trademarks . . . . . 11

**13 Contact information . . . . . 11**

**14 Contents . . . . . 12**

Please be aware that important notices concerning this document and the product(s) described herein, have been included in section 'Legal information'.



© NXP B.V. 2008.

All rights reserved.

For more information, please visit: <http://www.nxp.com>

For sales office addresses, please send an email to: [salesaddresses@nxp.com](mailto:salesaddresses@nxp.com)

Date of release: 7 February 2008

Document identifier: BTA202X\_SER\_D\_E\_1