

REV	ECN	APP'D
-	2939	JR 2/7/97
A	3043	AP 7/22/97
B	3338	JR 7/16/98
C	6200	JT 8/25/08
D	6349	JR 9/22/10

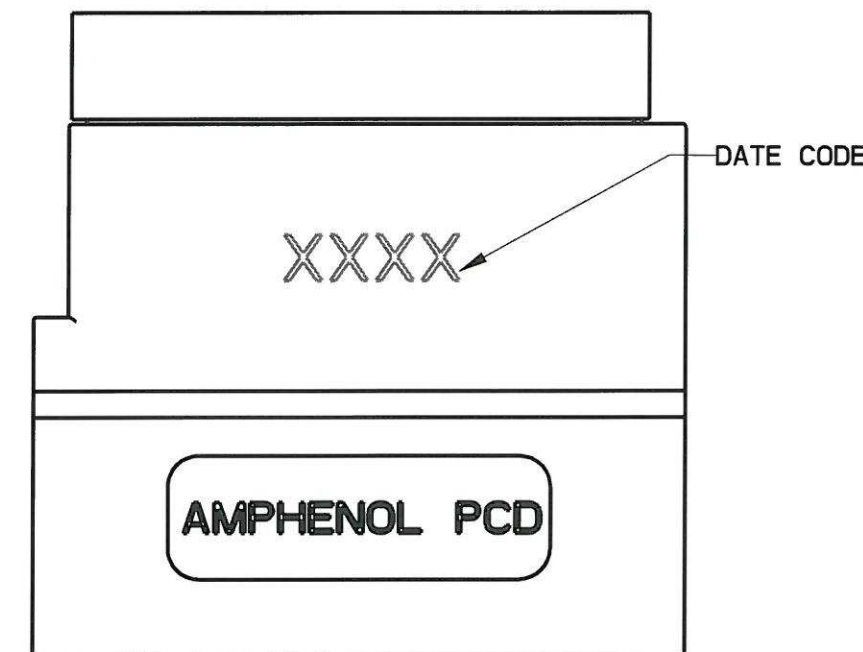
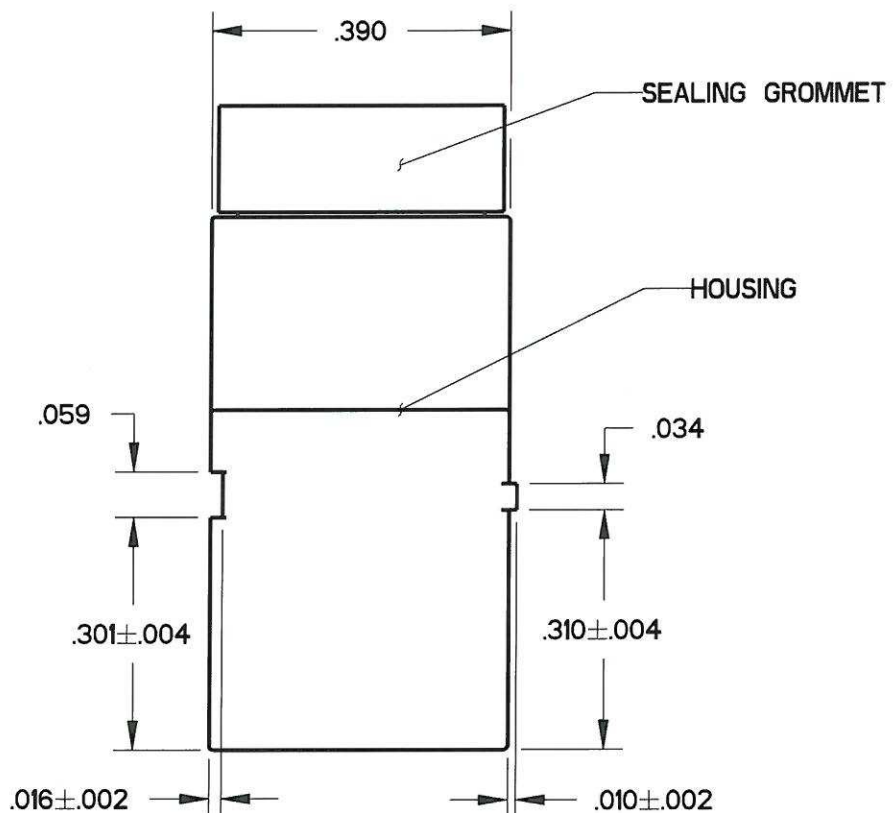
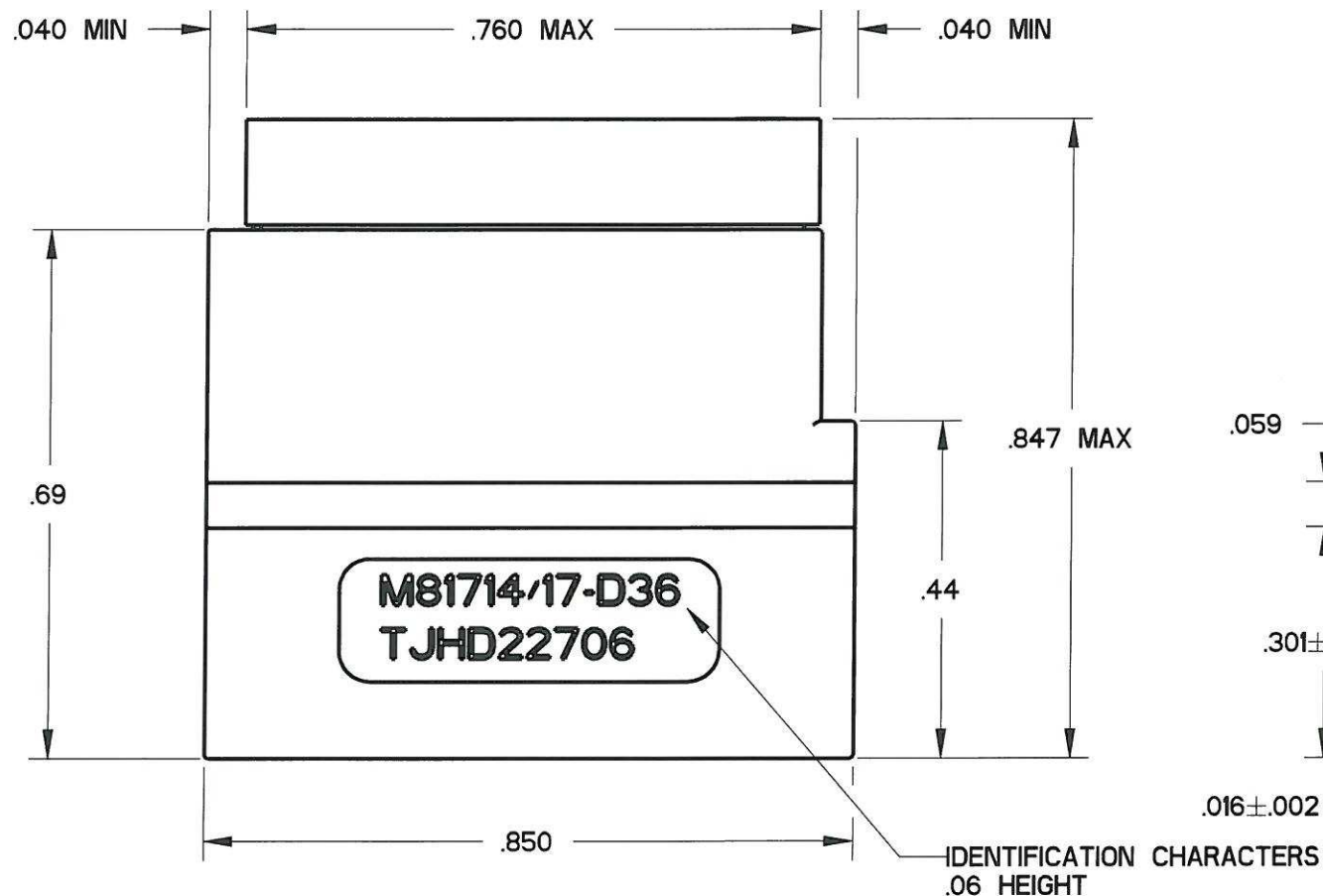
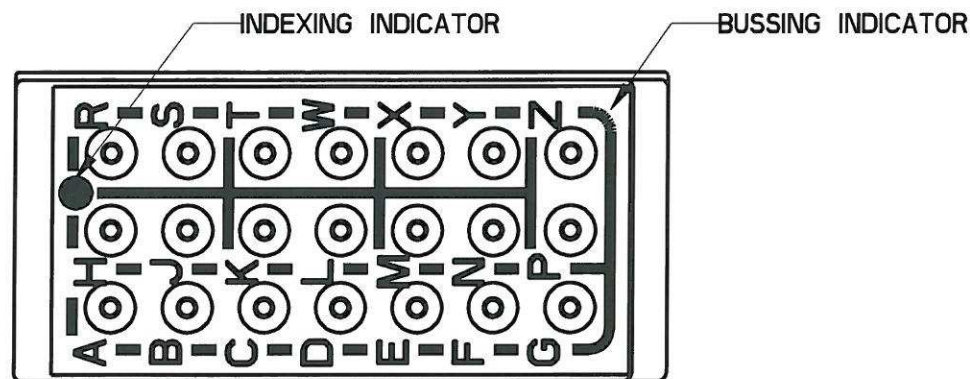

PART NO.	INCLUDED W/ MODULE
TJHD22606	MODULE ONLY
TJHD22706	22 EACH M39029/1-507 PIN CONTACTS 2 EACH MS27488-22 SEALING PLUGS

- NOTES:
 1. MATERIAL:
 HOUSING - THERMOPLASTIC, COLOR: BLACK.
 GROMMET - SILICONE RUBBER, COLOR: BLUE
 INTERNAL BUSSING - COPPER ALLOY
 2. MODULE ACCEPTS M39029/1-507 PIN CONTACTS

DIMENSIONS	TOLERANCES	PROJECTION	Amphenol Pcd SPECIFICATION DRAWING		
ANSI Y14.5M UNITS: INCHES Pro/E FILE	.XX ±0.01 .XXX ±0.005 ANGLES ±2.0°		ENGR A. PATRIE 3/08/06	TITLE MODULE, TERMINAL JUNCTION SIZE 22, HI-DENSITY D36 BUS ARRANGEMENT	
ORIGINAL	THIS DOCUMENT CONTAINS PROPRIETARY INFORMATION WHICH IS THE CONFIDENTIAL PROPERTY OF AMPHENOL PCD INC., BEVERLY, MA	CHKD 9/27/10	SIZE B	DWG NO. TJHD22606	REV D
		APPD 9/27/10	CODE: 58982	SCALE: 4:1	SHEET 1 OF 1

TJHD22606

TJHD22606