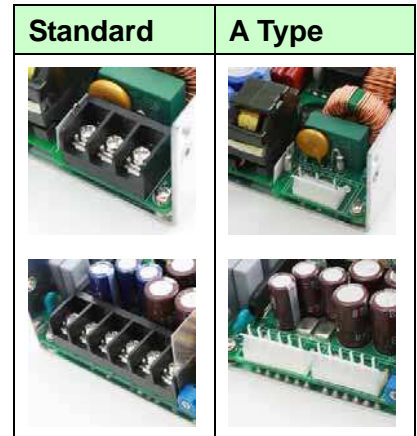

**KEY FEATURES**

- U Bracket Switching Power Supply
- Universal Input: 90-264 VAC
- Active P.F.C. Function, PF>0.95
- 300W Convection without FAN
- 480W Convection with 18CFM FAN
- Protections: Over Load / Over Voltage /  
Over Temperature / Short Circuit  
All by Auto-recovery
- Built-in Remote ON/OFF Control
- Stand by 5V @ 0.3A
- Stand by 5V @ 0.6A with 18CFM FAN
- High Efficiency up to 92%
- Ultra Compact Size: 7.0 x 4.2 x 1.78 Inches
- 3-Years Product Warranty

**ELECTRICAL SPECIFICATIONS**

Model No.	AQFC480U-12S	AQFC480U-24S	AQFC480U-36S	AQFC480U-48S		
Max Output Wattage (Convection) (W)	280W	280W	300W	300W		
Max Output Wattage (18CFM FAN) (W)	480W					
Input	Voltage					
	90-264 VAC or 120-370 VDC					
	Frequency (Hz)					
	47-63 Hz					
	Current (Full load)					
	< 5.5 A max. (115 VAC) / < 3.0 A max. (230 VAC)					
Inrush Current (<2ms)						
< 50 A max. (115 VAC) / < 70 A max. (230 VAC)						
Leakage Current						
< 0.5 mA max.(240VAC 63Hz)						
Power Factor						
PF>0.95 (115 VAC) / PF>0.90 (230 VAC) at Full Load						
Output	Constant Current Range (.VDC)	10 ~ 13.2V	20 ~ 26.4V	26 ~ 36V	30 ~ 50.4V	
	Current Adj. Range (Convection) (A) max	5 ~ 23.33	4 ~ 11.66	3 ~ 8.33	3 ~ 6.25	
	Current Adj. Range (18CFM FAN) (A) max	5 ~ 40	4 ~ 20	3 ~ 13.33	3 ~ 10	
	Minimum Load	5%				
	Maximum Capacitive Load	180000 uF	75000 uF	50000 uF	25000 uF	
	Ripple & Noise (max.)	100mVp-p	200mVp-p	200mVp-p	300mVp-p	
	Efficiency (Convection) (%)	Vin:115(V.AC)	88%	89%	90%	89%
		Vin:230(V.AC)	90%	91%	92%	91%
	Efficiency (18CFM FAN) (%)	Vin:115(V.AC)	85%	87%	89%	88%
		Vin:230(V.AC)	88%	90%	92%	91%
Hold-up Time	10 ms min.					
Switching Frequency	62.5 kHz ±10%					
Protection	Over Power Protection	Auto recovery				
	Over Voltage Protection	Auto recovery				
	Over Temperature	Auto recovery				
	Short Circuit Protection	Auto-recovery				
Isolation	Input-Output (V.AC)	3000V				
	Input-FG (V.AC)	1500V				
	Output-FG (V.AC)	500V				
Function	5V Stand by (18CFM FAN)	5VSB: 5V@0.6A ; Tolerance ±10% , Ripple & Noise: 100m Vp-p (max.)				
	Remote Control	+RC / -RC: Power ON=open ; Power OFF=short				
	FAN Control	12VDC / 0.5A max.				

1. All specifications valid at normal input voltage, full load and +25°C after warm-up time unless otherwise stated.
2. Ripple & Noise are measured at 20MHz of bandwidth with 0.1uF & 47uF parallel capacitor.

**ELECTRICAL SPECIFICATIONS**

Model No.	AQFC480U-12S	AQFC480U-24S	AQFC480U-36S	AQFC480U-48S				
Environment	Operating Temperature							
	-20°C...+70°C (with derating)							
	Storage Temperature							
	-25°C...+85°C							
	Temperature Coefficient							
±0.03%/°C ( 0~50°C )								
Humidity				95% RH				
MTBF				>100,000 h @ 25°C (MIL-HDBK-217F)				
Vibration				10~500Hz, 2G 10min./1cycle, 60min. each along X, Y, Z axes.				
Physical	Dimension (L x W x H)				7.0 x 4.2 x 1.78 Inches (177.8 x 106.5 x 45.0 mm) Tolerance ±0.5 mm			
	Weight				780 g			
Safety	Agency Approvals				UL60950-1, CE(Surge:4KV)			
EMC	EMI (Conducted & Radiated Emission)				EN 55022 class B			
	EMS (Noise Immunity)				EN 55024			

1. All specifications valid at normal input voltage, full load and +25°C after warm-up time unless otherwise stated.
2. Ripple & Noise are measured at 20MHz of bandwidth with 0.1uF & 47uF parallel capacitor.

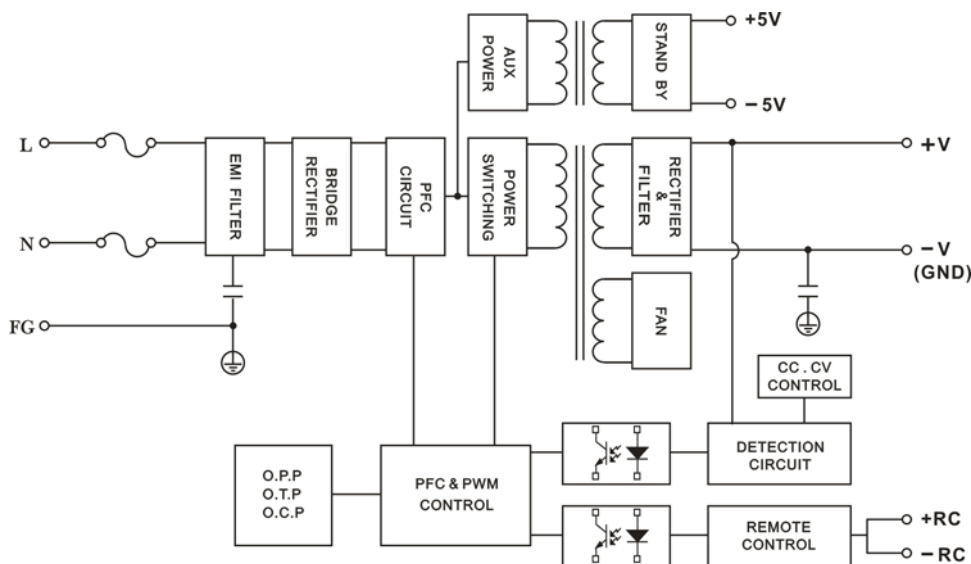
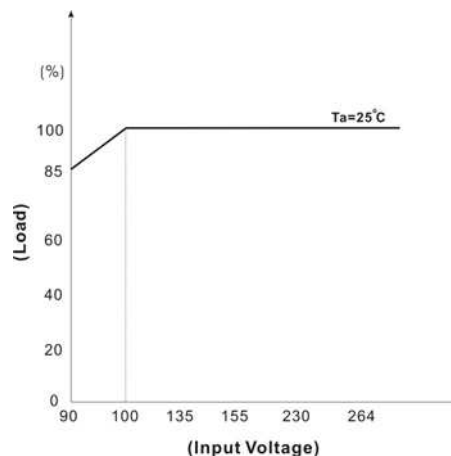
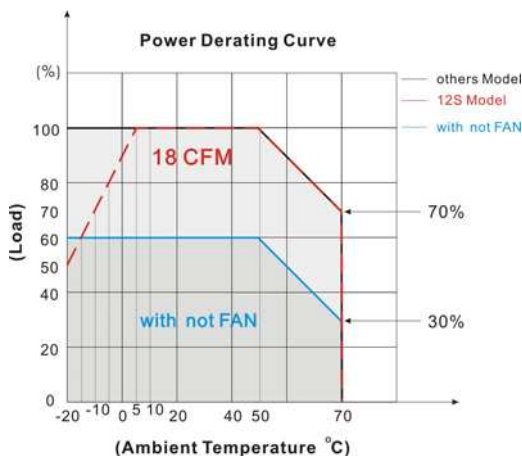
**BLOCK DIAGRAM**

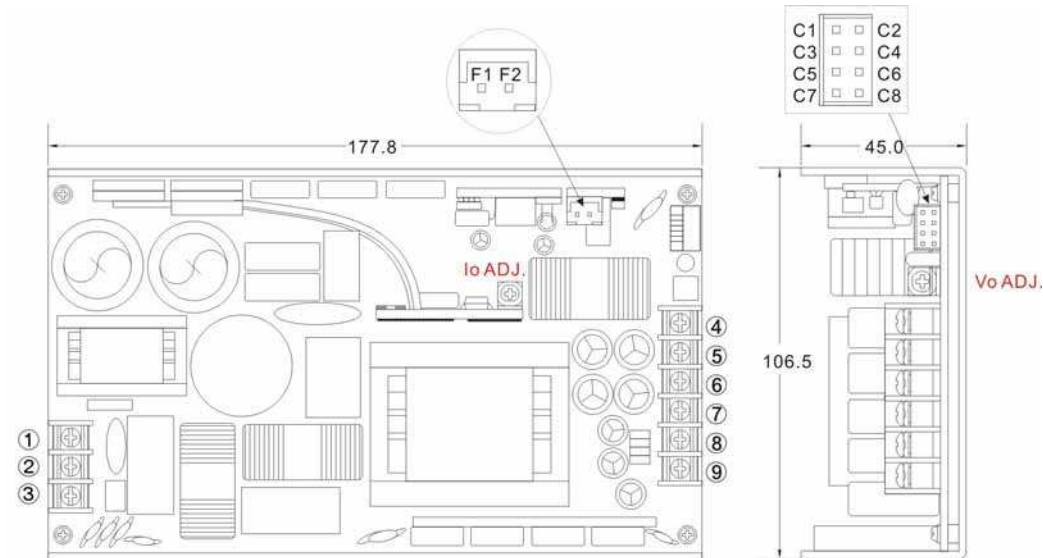
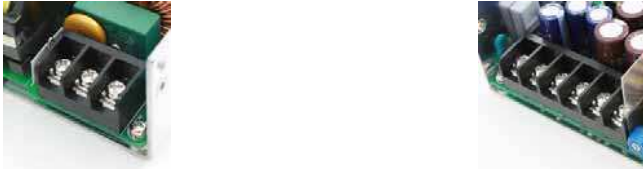
**DERATING**

**MECHANICAL DIMENSION**
**Standard**

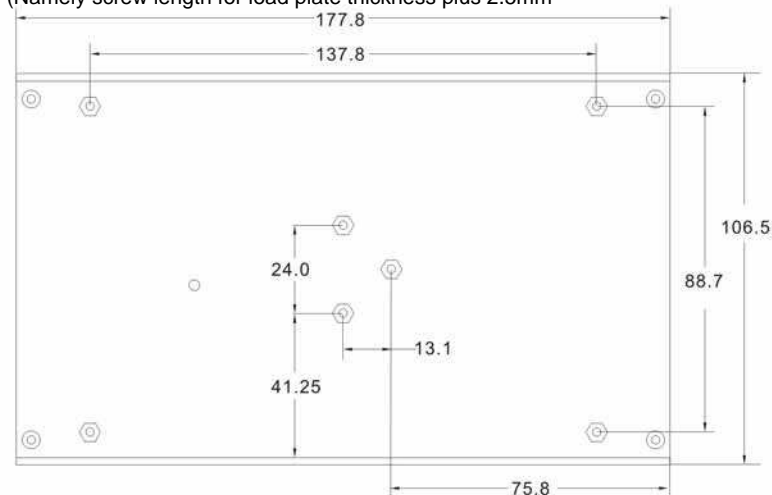
**ASSEMBLY INSTRUCTIONS**

\*U Case T=2.0mm

 Customer screws into the length of the case no higher than 0.5mm  
 (Namely screw length for load plate thickness plus 2.5mm)

**AC Input Terminal Pin**

PIN#	SINGLE
1	AC IN (N)
2	AC IN (L)
3	⏏

**DC Output Terminal Pin**

PIN#	SINGLE
4~6	+DC OUT
7~9	-DC OUT

**Connector Pin (CN4)**

PIN#	SINGLE
C1	NC
C2	NC
C3	+RC
C4	-RC
C5	NC
C6	NC
C7	+5V SB
C8	-5V SB

**FAN Molex Pin**

PIN#	SINGLE
F1	-DC
F2	+DC

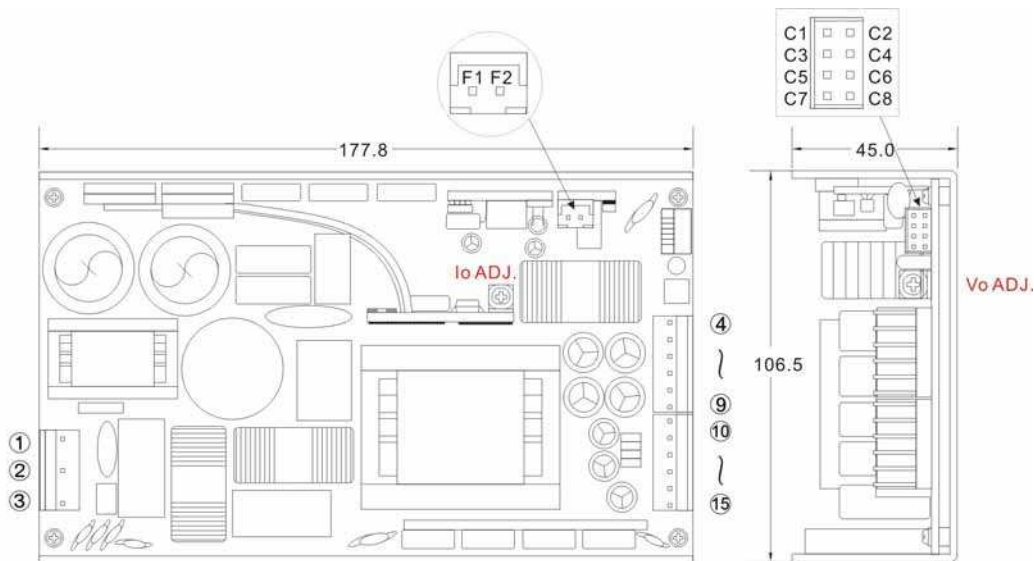
**MECHANICAL DIMENSION**
**A Type**

**ASSEMBLY INSTRUCTIONS**

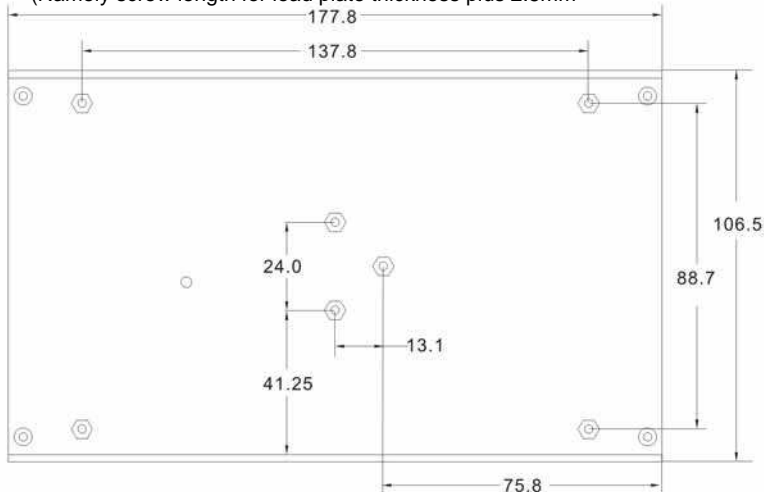
\*U Case T=2.0mm

 Customer screws into the length of the case no higher than 0.5mm  
 (Namely screw length for load plate thickness plus 2.5mm)

**AC Input Terminal Pin**

PIN#	SINGLE
1	AC IN (N)
2	AC IN (L)
3	⏏

**DC Output Terminal Pin**

PIN#	SINGLE
4~9	+DC OUT
10~15	-DC OUT

**Connector Pin (CN4)**

PIN#	SINGLE
C1	NC
C2	NC
C3	+RC
C4	-RC
C5	NC
C6	NC
C7	+5V SB
C8	-5V SB

**FAN Molex Pin**

PIN#	SINGLE
F1	-DC
F2	+DC

**FUNCTION DESCRIPITON of CN4 :**

Pin No.	Function	Description
C1	NC	
C2	NC	
C3	+RC	Turns the output on and off by electrical or dry contact between pin C4 (-RC), Short: Power OFF, Open: Power ON.
C4	-RC	Remote control ground.
C5	NC	
C6	NC	
C7	+5V SB	Stand by voltage output ground 4.5~5.5V, referenced to pin C8(-5V SB). The maximum load current is 0.6A.
C8	-5V SB	Stand by voltage output ground.

**FUNCTION MANUAL :**
**Remote Control**

It can be turned ON/OFF by using the "Remote Control" function.

Between RC+(pinC3) and RC-(pinC4)	Output Status
SW ON (Short)	OFF
SW OFF (Open)	ON

