



Date: 07/28/2010

# HIGH ENERGY SERIES

MAIDA STYLE NUMBER D75D8ZOV271RA550

MAIDA ITEM NUMBER 01-1809

**VARISTOR SPEC SHEET**

### Electrical Specifications

Continuous AC Voltage	270	VAC
Continuous DC Voltage	360	VDC
Maximum DC Leakage @ 360 VDC	200	uA
Low Varistor Voltage Limit	382	VDC
High Varistor Voltage Limit	466	VDC
Nominal Varistor Voltage	424	VDC
Current for Varistor Voltage	1	mA
Maximum Clamp Voltage	710	V
Maximum Clamp Voltage Test Current	300	A
Peak Current Rating (1 Pulse)	40000	A
Peak Current Rating (2 Pulse)	32000	A
Energy Rating (8X20us)	550	J
Energy Rating (10X1000us)	550	J
Typical Capacitance	2700	pF
Impulse Response Time	< 50	ns
Minimum Hipot of Coating	2500	VDC
Minimum I.R. of Coating	1000	MΩ
Current/Energy Derating Above 85°C	-2.5	%/°C

NOTE: Electrical Specifications are for each disc in package.

### Thermal Specifications

Minimum Operating Temperature	-40	°C
Maximum Operating Temperature	85	°C
Varistor Voltage Temperature Coeff	-0.05	%/°C
Minimum Storage Temperature	-50	°C
Maximum Storage Temperature	125	°C
Recommended Solder Temperature	260	°C
Recommended Reflow Temperature	260	°C

### Notes

### Physical Specifications

Lead Style	
X Nominal	1 in.
X Tolerance	0.02 in.
Y Nominal	0.242 in.
Y Tolerance	0.04 in.
Z Nominal	in.
Z Tolerance	in.
Lead Length Nominal	in.
Lead Length Tolerance	in.
d Nominal	0.02 in.
Wire Gauge	24 AWG
Minimum Marking	2xZ271-550UL
Nominal Disk Size	40 mm
D Maximum	1.65 in.
T Maximum	0.37 in.
H Maximum	2.225 in.
Coating Type	EPOXY

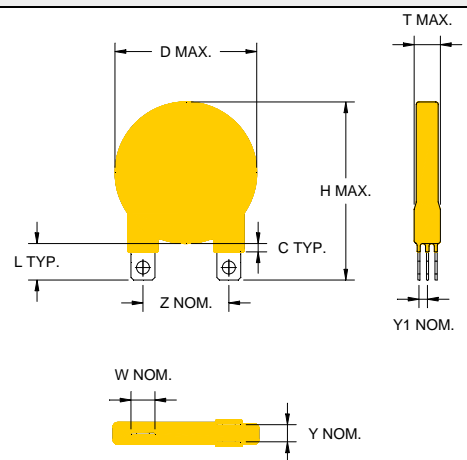

\* Contact Maida for a more detailed configuration drawing.

### Safety Agency Recognitions

UL 1449 File Number	E321173
- Tested to Type:	2
CSA File Number	
VDE File Number	
SEV File Number	



MAIDA DEVELOPMENT COMPANY

P.O. Box 3529

Hampton, Virginia 23663

www.maida.com

Ph: (757) 723-0785 Fax (757) 722-1194