



Date: 07/19/2010

HC SERIES

MAIDA STYLE NUMBER R61ZOV321HC

MAIDA ITEM NUMBER 01-1945

VARISTOR SPEC SHEET

Electrical Specifications

Continuous AC Voltage	320	VAC
Continuous DC Voltage	420	VDC
Maximum DC Leakage @ 420 VDC	200	uA
Low Varistor Voltage Limit	453	VDC
High Varistor Voltage Limit	553	VDC
Nominal Varistor Voltage	503	VDC
Current for Varistor Voltage	1	mA
Maximum Clamp Voltage	850	V
Maximum Clamp Voltage Test Current	20	A
Peak Current Rating (1 Pulse)	4500	A
Peak Current Rating (2 Pulse)	3500	A
Energy Rating (8X20us)	92	J
Energy Rating (10X1000us)	92	J
Typical Capacitance	220	pF
Impulse Response Time	< 50	ns
Minimum Hipot of Coating	2500	VDC
Minimum I.R. of Coating	1000	MΩ
Current/Energy Derating Above 85°C	-2.5	%/°C

Thermal Specifications

Minimum Operating Temperature	-40	°C
Maximum Operating Temperature	85	°C
Varistor Voltage Temperature Coeff	-0.05	%/°C
Minimum Storage Temperature	-50	°C
Maximum Storage Temperature	125	°C
Recommended Solder Temperature	260	°C
Recommended Reflow Temperature	260	°C

Notes

Physical Specifications

Lead Style	082J1
X Nominal	0.3 in.
X Tolerance	0.04 in.
Y Nominal	0.189 in.
Y Tolerance	0.03 in.
Z Nominal	0.354 in.
Z Tolerance	0.04 in.
Lead Length Nominal	1.0 in.
Lead Length Tolerance	min. in.
d Nominal	0.032 in.
Wire Gauge	20 AWG
Minimum Marking	R61-HZ321
Nominal Disk Size	9 mm
D Maximum	0.454 in.
T Maximum	0.359 in.
H Maximum	0.579 in.
Coating Type	EPOXY

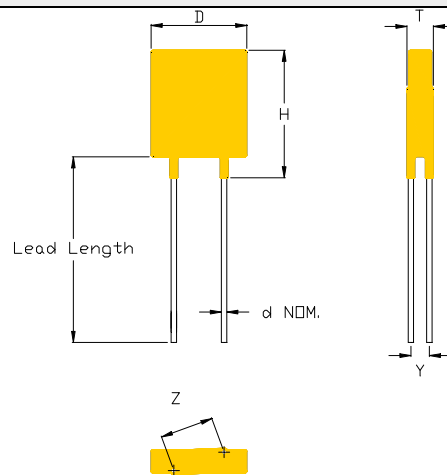

* Contact Maida for a more detailed configuration drawing.

Safety Agency Recognitions

UL 1449 File Number	E321173
- Tested to Type:	2
C-UL File Number	E321173
CSA File Number	
VDE File Number	
SEV File Number	



MAIDA DEVELOPMENT COMPANY
P.O. Box 3529
Hampton, Virginia 23663
Ph: (757) 723-0785 Fax (757) 722-1194

www.maida.com